

# Stormwater Report

Boxford, Massachusetts

---

**Harry Lee Cole School**

---

February 3, 2021  
Revised: November 1, 2021

JOB NO: ENG20-0865

Weston & Sampson<sup>SM</sup>

Weston & Sampson  
55 Walkers Brook Drive, Suite 100  
Reading, MA 01867

[www.westonandsampson.com](http://www.westonandsampson.com)  
Tel: 978-532-1900 Fax: 978-977-0100

## Table of Contents

Stormwater Checklist

Stormwater Report Summary

Attachment A - Locus Map

Attachment B - NRCS Soils Map, Soils Report, and HSG Classifications

Attachment C - Test Pit Logs & Infiltration Report

Attachment D - HydroCAD Reports

Attachment E - Calculations

1. TSS Removal Calcs
2. Isolator Row Sizing
3. Recharge Volume Calcs
4. Water Quality Volume Calcs
5. Hydraflow Calcs

Attachment F - Long Term Pollution Prevention Plan

Attachment G - Construction Period Pollution and Erosion and Sedimentation  
Control Plan

Attachment H - Operations & Maintenance Plan

Attachment I - Illicit Discharge Statement



# Checklist for Stormwater Report

## A. Introduction

**Important:** When filling out forms on the computer, use only the tab key to move your cursor - do not use the return key.

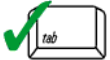

A Stormwater Report must be submitted with the Notice of Intent permit application to document compliance with the Stormwater Management Standards. The following checklist is NOT a substitute for the Stormwater Report (which should provide more substantive and detailed information) but is offered here as a tool to help the applicant organize their Stormwater Management documentation for their Report and for the reviewer to assess this information in a consistent format. As noted in the Checklist, the Stormwater Report must contain the engineering computations and supporting information set forth in Volume 3 of the [Massachusetts Stormwater Handbook](#). The Stormwater Report must be prepared and certified by a Registered Professional Engineer (RPE) licensed in the Commonwealth.

The Stormwater Report must include:

- The Stormwater Checklist completed and stamped by a Registered Professional Engineer (see page 2) that certifies that the Stormwater Report contains all required submittals.<sup>1</sup> This Checklist is to be used as the cover for the completed Stormwater Report.
- Applicant/Project Name
- Project Address
- Name of Firm and Registered Professional Engineer that prepared the Report
- Long-Term Pollution Prevention Plan required by Standards 4-6
- Construction Period Pollution Prevention and Erosion and Sedimentation Control Plan required by Standard 8<sup>2</sup>
- Operation and Maintenance Plan required by Standard 9

In addition to all plans and supporting information, the Stormwater Report must include a brief narrative describing stormwater management practices, including environmentally sensitive site design and LID techniques, along with a diagram depicting runoff through the proposed BMP treatment train. Plans are required to show existing and proposed conditions, identify all wetland resource areas, NRCS soil types, critical areas, Land Uses with Higher Potential Pollutant Loads (LUHPPL), and any areas on the site where infiltration rate is greater than 2.4 inches per hour. The Plans shall identify the drainage areas for both existing and proposed conditions at a scale that enables verification of supporting calculations.

As noted in the Checklist, the Stormwater Management Report shall document compliance with each of the Stormwater Management Standards as provided in the Massachusetts Stormwater Handbook. The soils evaluation and calculations shall be done using the methodologies set forth in Volume 3 of the Massachusetts Stormwater Handbook.

To ensure that the Stormwater Report is complete, applicants are required to fill in the Stormwater Report Checklist by checking the box to indicate that the specified information has been included in the Stormwater Report. If any of the information specified in the checklist has not been submitted, the applicant must provide an explanation. The completed Stormwater Report Checklist and Certification must be submitted with the Stormwater Report.

<sup>1</sup> The Stormwater Report may also include the Illicit Discharge Compliance Statement required by Standard 10. If not included in the Stormwater Report, the Illicit Discharge Compliance Statement must be submitted prior to the discharge of stormwater runoff to the post-construction best management practices.

<sup>2</sup> For some complex projects, it may not be possible to include the Construction Period Erosion and Sedimentation Control Plan in the Stormwater Report. In that event, the issuing authority has the discretion to issue an Order of Conditions that approves the project and includes a condition requiring the proponent to submit the Construction Period Erosion and Sedimentation Control Plan before commencing any land disturbance activity on the site.



# Checklist for Stormwater Report

---

## B. Stormwater Checklist and Certification

The following checklist is intended to serve as a guide for applicants as to the elements that ordinarily need to be addressed in a complete Stormwater Report. The checklist is also intended to provide conservation commissions and other reviewing authorities with a summary of the components necessary for a comprehensive Stormwater Report that addresses the ten Stormwater Standards.

*Note:* Because stormwater requirements vary from project to project, it is possible that a complete Stormwater Report may not include information on some of the subjects specified in the Checklist. If it is determined that a specific item does not apply to the project under review, please note that the item is not applicable (N.A.) and provide the reasons for that determination.

A complete checklist must include the Certification set forth below signed by the Registered Professional Engineer who prepared the Stormwater Report.

---

### Registered Professional Engineer's Certification

I have reviewed the Stormwater Report, including the soil evaluation, computations, Long-term Pollution Prevention Plan, the Construction Period Erosion and Sedimentation Control Plan (if included), the Long-term Post-Construction Operation and Maintenance Plan, the Illicit Discharge Compliance Statement (if included) and the plans showing the stormwater management system, and have determined that they have been prepared in accordance with the requirements of the Stormwater Management Standards as further elaborated by the Massachusetts Stormwater Handbook. I have also determined that the information presented in the Stormwater Checklist is accurate and that the information presented in the Stormwater Report accurately reflects conditions at the site as of the date of this permit application.

Registered Professional Engineer Block and Signature

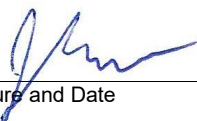

 11/5/2021  
\_\_\_\_\_  
Signature and Date

---

## Checklist

**Project Type:** Is the application for new development, redevelopment, or a mix of new and redevelopment?

- New development
- Redevelopment
- Mix of New Development and Redevelopment



# Checklist for Stormwater Report

---

## Checklist (continued)

**LID Measures:** Stormwater Standards require LID measures to be considered. Document what environmentally sensitive design and LID Techniques were considered during the planning and design of the project:

- No disturbance to any Wetland Resource Areas
- Site Design Practices (e.g. clustered development, reduced frontage setbacks)
- Reduced Impervious Area (Redevelopment Only)
- Minimizing disturbance to existing trees and shrubs
- LID Site Design Credit Requested:
  - Credit 1
  - Credit 2
  - Credit 3
- Use of "country drainage" versus curb and gutter conveyance and pipe
- Bioretention Cells (includes Rain Gardens)
- Constructed Stormwater Wetlands (includes Gravel Wetlands designs)
- Treebox Filter
- Water Quality Swale
- Grass Channel
- Green Roof
- Other (describe): \_\_\_\_\_

### Standard 1: No New Untreated Discharges

- No new untreated discharges
- Outlets have been designed so there is no erosion or scour to wetlands and waters of the Commonwealth
- Supporting calculations specified in Volume 3 of the Massachusetts Stormwater Handbook included.



# Checklist for Stormwater Report

---

## Checklist (continued)

### Standard 2: Peak Rate Attenuation

- Standard 2 waiver requested because the project is located in land subject to coastal storm flowage and stormwater discharge is to a wetland subject to coastal flooding.
- Evaluation provided to determine whether off-site flooding increases during the 100-year 24-hour storm.
- Calculations provided to show that post-development peak discharge rates do not exceed pre-development rates for the 2-year and 10-year 24-hour storms. If evaluation shows that off-site flooding increases during the 100-year 24-hour storm, calculations are also provided to show that post-development peak discharge rates do not exceed pre-development rates for the 100-year 24-hour storm.

### Standard 3: Recharge

- Soil Analysis provided.
- Required Recharge Volume calculation provided.
- Required Recharge volume reduced through use of the LID site Design Credits.
- Sizing the infiltration, BMPs is based on the following method: Check the method used.
  - Static
  - Simple Dynamic
  - Dynamic Field<sup>1</sup>
- Runoff from all impervious areas at the site discharging to the infiltration BMP.
- Runoff from all impervious areas at the site is *not* discharging to the infiltration BMP and calculations are provided showing that the drainage area contributing runoff to the infiltration BMPs is sufficient to generate the required recharge volume.
- Recharge BMPs have been sized to infiltrate the Required Recharge Volume.
- Recharge BMPs have been sized to infiltrate the Required Recharge Volume *only* to the maximum extent practicable for the following reason:
  - Site is comprised solely of C and D soils and/or bedrock at the land surface
  - M.G.L. c. 21E sites pursuant to 310 CMR 40.0000
  - Solid Waste Landfill pursuant to 310 CMR 19.000
  - Project is otherwise subject to Stormwater Management Standards only to the maximum extent practicable.
- Calculations showing that the infiltration BMPs will drain in 72 hours are provided.
- Property includes a M.G.L. c. 21E site or a solid waste landfill and a mounding analysis is included.

---

<sup>1</sup> 80% TSS removal is required prior to discharge to infiltration BMP if Dynamic Field method is used.



# Checklist for Stormwater Report

---

## Checklist (continued)

### Standard 3: Recharge (continued)

- The infiltration BMP is used to attenuate peak flows during storms greater than or equal to the 10-year 24-hour storm and separation to seasonal high groundwater is less than 4 feet and a mounding analysis is provided.
- Documentation is provided showing that infiltration BMPs do not adversely impact nearby wetland resource areas.

### Standard 4: Water Quality

The Long-Term Pollution Prevention Plan typically includes the following:

- Good housekeeping practices;
  - Provisions for storing materials and waste products inside or under cover;
  - Vehicle washing controls;
  - Requirements for routine inspections and maintenance of stormwater BMPs;
  - Spill prevention and response plans;
  - Provisions for maintenance of lawns, gardens, and other landscaped areas;
  - Requirements for storage and use of fertilizers, herbicides, and pesticides;
  - Pet waste management provisions;
  - Provisions for operation and management of septic systems;
  - Provisions for solid waste management;
  - Snow disposal and plowing plans relative to Wetland Resource Areas;
  - Winter Road Salt and/or Sand Use and Storage restrictions;
  - Street sweeping schedules;
  - Provisions for prevention of illicit discharges to the stormwater management system;
  - Documentation that Stormwater BMPs are designed to provide for shutdown and containment in the event of a spill or discharges to or near critical areas or from LUHPPL;
  - Training for staff or personnel involved with implementing Long-Term Pollution Prevention Plan;
  - List of Emergency contacts for implementing Long-Term Pollution Prevention Plan.
- A Long-Term Pollution Prevention Plan is attached to Stormwater Report and is included as an attachment to the Wetlands Notice of Intent.
  - Treatment BMPs subject to the 44% TSS removal pretreatment requirement and the one inch rule for calculating the water quality volume are included, and discharge:
    - is within the Zone II or Interim Wellhead Protection Area
    - is near or to other critical areas
    - is within soils with a rapid infiltration rate (greater than 2.4 inches per hour)
    - involves runoff from land uses with higher potential pollutant loads.
  - The Required Water Quality Volume is reduced through use of the LID site Design Credits.
  - Calculations documenting that the treatment train meets the 80% TSS removal requirement and, if applicable, the 44% TSS removal pretreatment requirement, are provided.



# Checklist for Stormwater Report

---

## Checklist (continued)

### Standard 4: Water Quality (continued)

- The BMP is sized (and calculations provided) based on:
  - The ½" or 1" Water Quality Volume or
  - The equivalent flow rate associated with the Water Quality Volume and documentation is provided showing that the BMP treats the required water quality volume.
- The applicant proposes to use proprietary BMPs, and documentation supporting use of proprietary BMP and proposed TSS removal rate is provided. This documentation may be in the form of the propriety BMP checklist found in Volume 2, Chapter 4 of the Massachusetts Stormwater Handbook and submitting copies of the TARP Report, STEP Report, and/or other third party studies verifying performance of the proprietary BMPs.
- A TMDL exists that indicates a need to reduce pollutants other than TSS and documentation showing that the BMPs selected are consistent with the TMDL is provided.

### Standard 5: Land Uses With Higher Potential Pollutant Loads (LUHPPLs)

- The NPDES Multi-Sector General Permit covers the land use and the Stormwater Pollution Prevention Plan (SWPPP) has been included with the Stormwater Report.
- The NPDES Multi-Sector General Permit covers the land use and the SWPPP will be submitted **prior to** the discharge of stormwater to the post-construction stormwater BMPs.
- The NPDES Multi-Sector General Permit does **not** cover the land use.
- LUHPPLs are located at the site and industry specific source control and pollution prevention measures have been proposed to reduce or eliminate the exposure of LUHPPLs to rain, snow, snow melt and runoff, and been included in the long term Pollution Prevention Plan.
- All exposure has been eliminated.
- All exposure has **not** been eliminated and all BMPs selected are on MassDEP LUHPPL list.
- The LUHPPL has the potential to generate runoff with moderate to higher concentrations of oil and grease (e.g. all parking lots with >1000 vehicle trips per day) and the treatment train includes an oil grit separator, a filtering bioretention area, a sand filter or equivalent.

### Standard 6: Critical Areas

- The discharge is near or to a critical area and the treatment train includes only BMPs that MassDEP has approved for stormwater discharges to or near that particular class of critical area.
- Critical areas and BMPs are identified in the Stormwater Report.





# Checklist for Stormwater Report

---

## Checklist (continued)

### Standard 7: Redevelopments and Other Projects Subject to the Standards only to the maximum extent practicable

- The project is subject to the Stormwater Management Standards only to the maximum Extent Practicable as a:
- Limited Project
  - Small Residential Projects: 5-9 single family houses or 5-9 units in a multi-family development provided there is no discharge that may potentially affect a critical area.
  - Small Residential Projects: 2-4 single family houses or 2-4 units in a multi-family development with a discharge to a critical area
  - Marina and/or boatyard provided the hull painting, service and maintenance areas are protected from exposure to rain, snow, snow melt and runoff
  - Bike Path and/or Foot Path
  - Redevelopment Project
  - Redevelopment portion of mix of new and redevelopment.
- Certain standards are not fully met (Standard No. 1, 8, 9, and 10 must always be fully met) and an explanation of why these standards are not met is contained in the Stormwater Report.
- The project involves redevelopment and a description of all measures that have been taken to improve existing conditions is provided in the Stormwater Report. The redevelopment checklist found in Volume 2 Chapter 3 of the Massachusetts Stormwater Handbook may be used to document that the proposed stormwater management system (a) complies with Standards 2, 3 and the pretreatment and structural BMP requirements of Standards 4-6 to the maximum extent practicable and (b) improves existing conditions.

### Standard 8: Construction Period Pollution Prevention and Erosion and Sedimentation Control

A Construction Period Pollution Prevention and Erosion and Sedimentation Control Plan must include the following information:

- Narrative;
  - Construction Period Operation and Maintenance Plan;
  - Names of Persons or Entity Responsible for Plan Compliance;
  - Construction Period Pollution Prevention Measures;
  - Erosion and Sedimentation Control Plan Drawings;
  - Detail drawings and specifications for erosion control BMPs, including sizing calculations;
  - Vegetation Planning;
  - Site Development Plan;
  - Construction Sequencing Plan;
  - Sequencing of Erosion and Sedimentation Controls;
  - Operation and Maintenance of Erosion and Sedimentation Controls;
  - Inspection Schedule;
  - Maintenance Schedule;
  - Inspection and Maintenance Log Form.
- A Construction Period Pollution Prevention and Erosion and Sedimentation Control Plan containing the information set forth above has been included in the Stormwater Report.



# Checklist for Stormwater Report

---

## Checklist (continued)

### Standard 8: Construction Period Pollution Prevention and Erosion and Sedimentation Control (continued)

- The project is highly complex and information is included in the Stormwater Report that explains why it is not possible to submit the Construction Period Pollution Prevention and Erosion and Sedimentation Control Plan with the application. A Construction Period Pollution Prevention and Erosion and Sedimentation Control has **not** been included in the Stormwater Report but will be submitted **before** land disturbance begins.
- The project is **not** covered by a NPDES Construction General Permit.
- The project is covered by a NPDES Construction General Permit and a copy of the SWPPP is in the Stormwater Report.
- The project is covered by a NPDES Construction General Permit but no SWPPP been submitted. The SWPPP will be submitted BEFORE land disturbance begins.

### Standard 9: Operation and Maintenance Plan

- The Post Construction Operation and Maintenance Plan is included in the Stormwater Report and includes the following information:
  - Name of the stormwater management system owners;
  - Party responsible for operation and maintenance;
  - Schedule for implementation of routine and non-routine maintenance tasks;
  - Plan showing the location of all stormwater BMPs maintenance access areas;
  - Description and delineation of public safety features;
  - Estimated operation and maintenance budget; and
  - Operation and Maintenance Log Form.
- The responsible party is **not** the owner of the parcel where the BMP is located and the Stormwater Report includes the following submissions:
  - A copy of the legal instrument (deed, homeowner's association, utility trust or other legal entity) that establishes the terms of and legal responsibility for the operation and maintenance of the project site stormwater BMPs;
  - A plan and easement deed that allows site access for the legal entity to operate and maintain BMP functions.

### Standard 10: Prohibition of Illicit Discharges

- The Long-Term Pollution Prevention Plan includes measures to prevent illicit discharges;
- An Illicit Discharge Compliance Statement is attached;
- NO Illicit Discharge Compliance Statement is attached but will be submitted **prior to** the discharge of any stormwater to post-construction BMPs.

# Stormwater Report

November 1, 2021

Applicant/Project Name: Town of Boxford  
Harry Lee Cole School

Project Address: 26 Middleton Road, Boxford, MA

Application Prepared by:

Firm: Weston & Sampson, Inc.

Registered PE: James Pearson

Below is an explanation concerning Standards 1-10 as they apply to the Harry Lee Cole School project:

## **General:**

The project applicant, the Town of Boxford, proposes a redevelopment project at the Harry Lee Cole School located at 26 Middleton Road in Boxford to improve site access and traffic circulation. Site work will include, but is not limited to grading, drainage, paving and landscaping. The site is actively used as an elementary school for the town of Boxford and will remain in use over the duration of the project. The site is predominantly developed, with a large wooded area, which contains a drinking water well, placing part of the site under Zone I well head protection. Existing topography is relatively moderate across the site, with elevations ranging from 102-FT at the northeastern portion of the site to a low of approximately 91-FT to the southeast, along Main Street. NRCS soil mapping describes the site as being a mixture of Sudbury FSL (HSG-B) and Charlton-Hollis Rock Outcrop Complex (HSG-A). Test pits conducted across the site generally support the soil mapping and can be found in Attachment C of this report.

## **Standard 1: No New Untreated Discharges**

The proposed project will create no new untreated discharges. Total impervious area will be increased in comparison with existing conditions by approximately 5,000-SF. Approximately 57,000-SF± of impervious area will now undergo treatment via street sweeping, deep sump hooded catch basins, and subsurface treatment chambers or bio-retention areas. As such, existing stormwater discharges will meet Standard 1 to the maximum extent practicable. HydroCAD modeling of the site is provided in Attachment D.

## **Standard 2: Peak Rate Attenuation**

Existing and proposed conditions were modeled using HydroCAD computer software and Town of Boxford rainfall data. A table, summarizing peak discharges for the 2-Yr, 10-Yr, 25-Yr , 50-Yr and 100-Yr storm events can be found in Attachment D. The proposed design is such that peak runoff volumes and peak discharge rates do not exceed pre-development rates, even in the 100-year storm scenario.

To ensure that the work incorporates the performance standards recommended in the DEP's Stormwater Management Policy, necessary erosion and sedimentation control measures will be utilized during construction, as depicted on the site plans.

## **Standard 3: Recharge**

As a redevelopment, Standard 3 shall be met to the maximum extent practicable. Due to shallow estimated seasonal high groundwater on site and the presence of a Zone I wellhead protection area, only a single infiltration BMP is being proposed for recharge on site. The BMP is designed to capture and infiltrate the required recharge volume for the contributing subcatchments. Supporting calculations can be found in Attachment E of this report.

## **Standard 4: Water Quality**

Standard 4 shall be met to the maximum extent practicable. Treatment practices have been designed to capture the required water quality volume and provide treatment to remove greater than 80% of total suspended solids where able. The proposed stormwater management system will present an improvement over existing conditions.

During the project, appropriate BMPs will be used to minimize sedimentation and soil erosion.

## **Standard 5: Land Uses with Higher Potential Pollutant Loads (LUHPPLs)**

This site is not considered a LUHPPL, as such, Standard 5 does not apply.

## **Standard 6: Critical Areas**

Portions of the site are located within a Zone I wellhead protection area, with the remainder of the site being located within a Zone II. Measures have been taken to ensure that adequate pretreatment is provided prior to groundwater recharge. Stormwater infiltration BMP's are located outside of the Zone I.

**Standard 7: Redevelopments and Other Projects Subject to the Standards Only to the Maximum Extent Practicable**

This is a redevelopment project. Stormwater standards 1, 2, 3 and 4 have been met to the maximum extent practicable.

**Standard 8: Construction Period Pollution Prevention and Erosion and Sediment Control**

A detailed Construction Period Pollution Prevention and Erosion and Sedimentation Control Plan is included in Attachment G. To ensure that the work incorporates the performance standards recommended in the DEP's Stormwater Management Policy, necessary erosion and sedimentation control measures will be utilized during construction.

**Standard 9: Operation and Maintenance Plan**

An operations and maintenance plan is included in Attachment H.

**Standard 10: Prohibition of Illicit Discharges**

An illicit discharge compliance statement has been included in Attachment I.

**Registered Professional Engineer's Certification**

I have reviewed the Stormwater Report, including any relevant soil evaluations, computations, Long-term Pollution Prevention Plan, the Construction Period Erosion and Sedimentation Control Plan, the Long-term Post-Construction Operation and Maintenance Plan, the Illicit Discharge Compliance Statement and the plans showing the stormwater management system, and have determined that they have been prepared in accordance with the requirements of the Stormwater Management Standards as further elaborated by the Massachusetts Stormwater Handbook. I have also determined that the information presented in the Stormwater Checklist is accurate and that the information presented in the Stormwater Report accurately reflects conditions at the site as of the date of this permit application.

Registered Professional Engineer Block and Signature

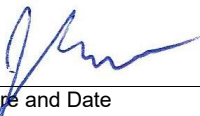

 11/1/2021  
\_\_\_\_\_  
Signature and Date

**Attachment A - Locus Map**



Legend  
Site Location

Attachment A  
Locus Map  
Harry Lee Cole School  
USGS Topographic Map

Data Source: Office of Geographic and Environmental Information (MassGIS), Commonwealth of Massachusetts Executive Office of Environmental Affairs





**Attachment B - NRCS Soils Map, Soils Report, and HSG  
Classifications**



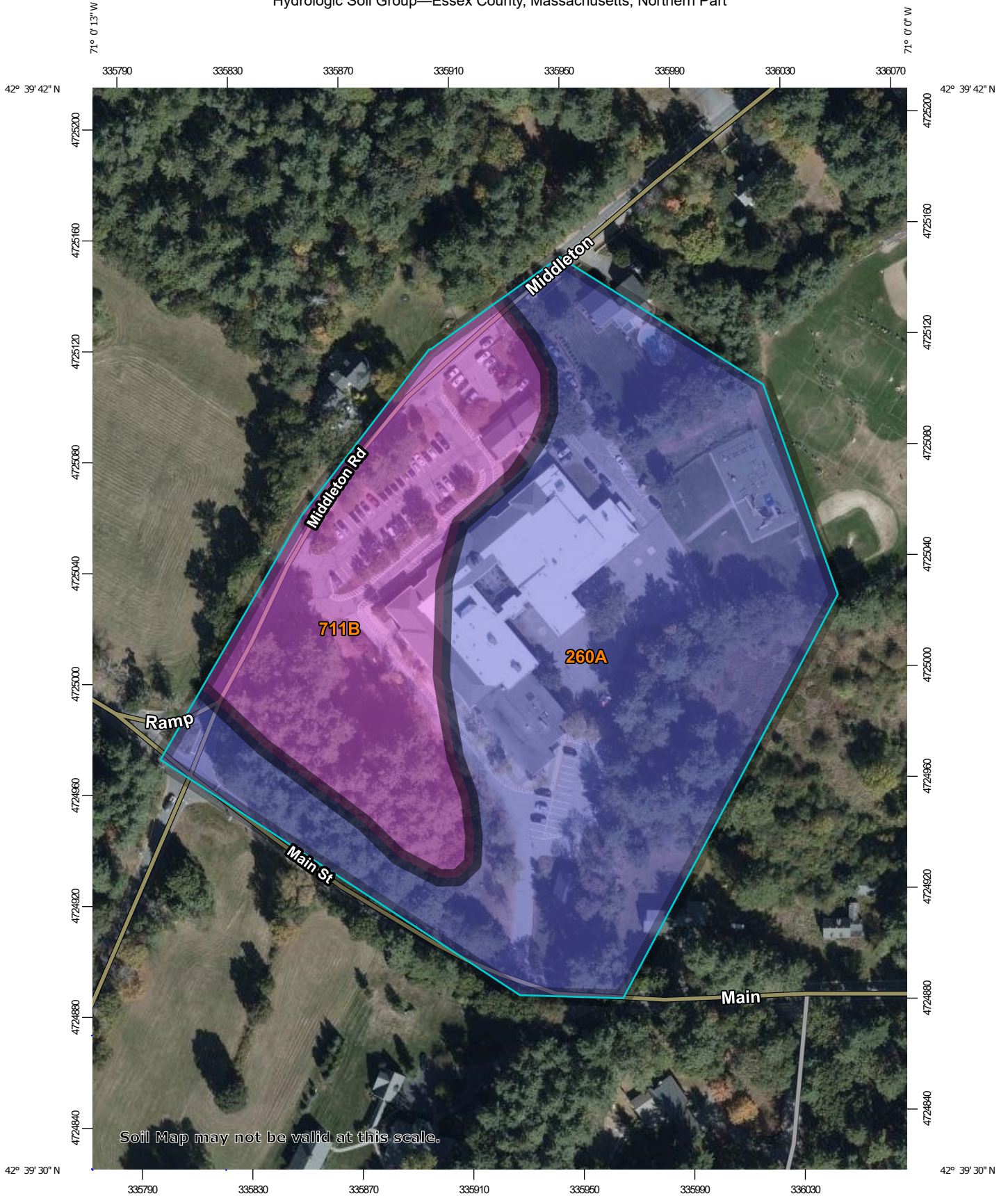



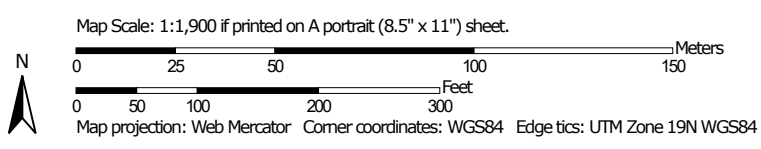

















Hydrologic Soil Group—Essex County, Massachusetts, Northern Part



Soil Map may not be valid at this scale.



## MAP LEGEND

<b>Area of Interest (AOI)</b>	 C
Area of Interest (AOI)	 C/D
<b>Soils</b>	 D
<b>Soil Rating Polygons</b>	 Not rated or not available
A	 Streams and Canals
A/D	 Transportation
B	 RAILS
B/D	 Interstate Highways
C	 US Routes
C/D	 Major Roads
D	 Local Roads
Not rated or not available	 Background
<b>Soil Rating Lines</b>	 Aerial Photography
A	
A/D	
B	
B/D	
C	
C/D	
D	
Not rated or not available	
<b>Soil Rating Points</b>	
A	
A/D	
B	
B/D	

## MAP INFORMATION

The soil surveys that comprise your AOI were mapped at 1:15,800.

Warning: Soil Map may not be valid at this scale.

Enlargement of maps beyond the scale of mapping can cause misunderstanding of the detail of mapping and accuracy of soil line placement. The maps do not show the small areas of contrasting soils that could have been shown at a more detailed scale.

Please rely on the bar scale on each map sheet for map measurements.

Source of Map: Natural Resources Conservation Service  
 Web Soil Survey URL:  
 Coordinate System: Web Mercator (EPSG:3857)

Maps from the Web Soil Survey are based on the Web Mercator projection, which preserves direction and shape but distorts distance and area. A projection that preserves area, such as the Albers equal-area conic projection, should be used if more accurate calculations of distance or area are required.

This product is generated from the USDA-NRCS certified data as of the version date(s) listed below.

Soil Survey Area: Essex County, Massachusetts, Northern Part  
 Survey Area Data: Version 16, Jun 9, 2020

Soil map units are labeled (as space allows) for map scales 1:50,000 or larger.

Date(s) aerial images were photographed: Sep 13, 2019—Oct 5, 2019

The orthophoto or other base map on which the soil lines were compiled and digitized probably differs from the background imagery displayed on these maps. As a result, some minor shifting of map unit boundaries may be evident.

## Hydrologic Soil Group

Map unit symbol	Map unit name	Rating	Acres in AOI	Percent of AOI
260A	Sudbury fine sandy loam, 0 to 3 percent slopes	B	6.8	69.6%
711B	Charlton-Rock outcrop-Hollis complex, 3 to 8 percent slopes	A	3.0	30.4%
<b>Totals for Area of Interest</b>			<b>9.8</b>	<b>100.0%</b>

### Description

Hydrologic soil groups are based on estimates of runoff potential. Soils are assigned to one of four groups according to the rate of water infiltration when the soils are not protected by vegetation, are thoroughly wet, and receive precipitation from long-duration storms.

The soils in the United States are assigned to four groups (A, B, C, and D) and three dual classes (A/D, B/D, and C/D). The groups are defined as follows:

Group A. Soils having a high infiltration rate (low runoff potential) when thoroughly wet. These consist mainly of deep, well drained to excessively drained sands or gravelly sands. These soils have a high rate of water transmission.

Group B. Soils having a moderate infiltration rate when thoroughly wet. These consist chiefly of moderately deep or deep, moderately well drained or well drained soils that have moderately fine texture to moderately coarse texture. These soils have a moderate rate of water transmission.

Group C. Soils having a slow infiltration rate when thoroughly wet. These consist chiefly of soils having a layer that impedes the downward movement of water or soils of moderately fine texture or fine texture. These soils have a slow rate of water transmission.

Group D. Soils having a very slow infiltration rate (high runoff potential) when thoroughly wet. These consist chiefly of clays that have a high shrink-swell potential, soils that have a high water table, soils that have a claypan or clay layer at or near the surface, and soils that are shallow over nearly impervious material. These soils have a very slow rate of water transmission.

If a soil is assigned to a dual hydrologic group (A/D, B/D, or C/D), the first letter is for drained areas and the second is for undrained areas. Only the soils that in their natural condition are in group D are assigned to dual classes.

## Rating Options

*Aggregation Method:* Dominant Condition

*Component Percent Cutoff:* None Specified

*Tie-break Rule:* Higher

**Attachment C - Test Pit Logs & Infiltration Report**

Soil Map—Essex County, Massachusetts, Northern Part  
(Harry Lee Cole School)

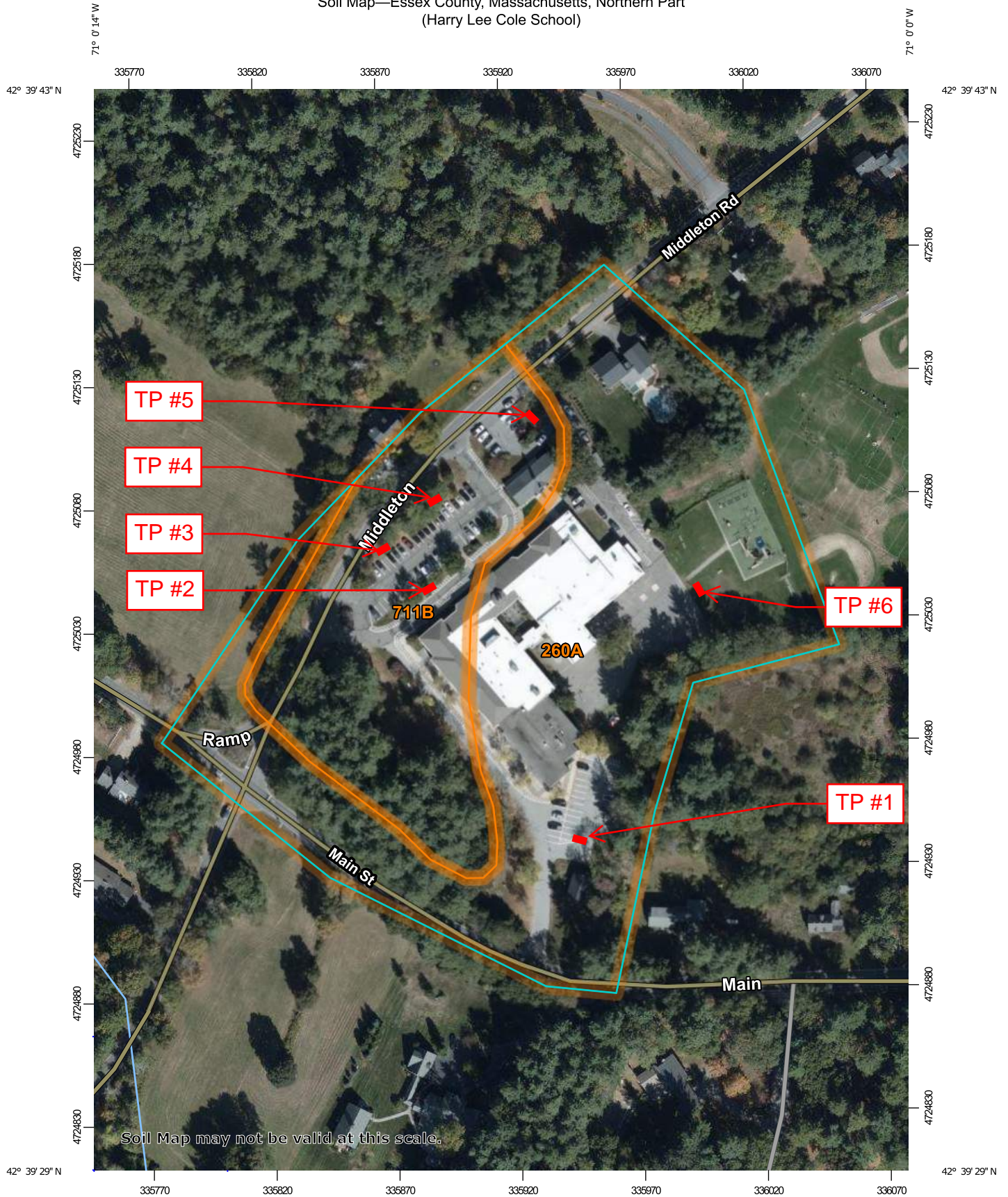

Soil Map may not be valid at this scale.

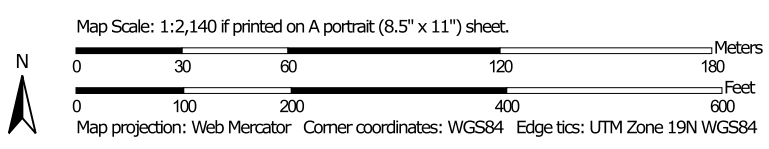

**TEST PIT LOG**

PROJECT NAME/NO.	Harry Lee Cole School - ENG20-0865	<b>TEST PIT NUMBER</b> TP 1
LOCATION	Harry Lee Cole School, Boxford, MA	
CLIENT	Boxford, MA	GROUND SURFACE
CONTRACTOR	RE Thompson	FOREMAN: see plan
OBSERVED BY	K. Elmy	DATE 1/20/21
CHECKED BY		DATE
		DEPTH TO GROUNDWATER BELOW SURFACE 48-in

DEPTH BELOW GROUND SURFACE (in.)	TEST PIT DIAGRAM AND SOIL DESCRIPTION
4"	Pavement
25"	Fill 10% Gravel & 10% Cobbles
29"	Ab - Dark Brown Sandy Loam (10YR 3/3) 10% Gravel & 10% Cobbles
35"	Bw - Dark Yellowish Brown Sandy Loam (10YR 4/6) 10% Gravel & 10% Cobbles
84"	C1 - Yellowish Brown Coarse Sand (10YR 5/4) 5% Gravel
	- End of Exploration -

<b>NOTES:</b> 1. Redox encountered at 48-in 2. Weeping at 75-in 3. PID = 0.0PPM	<b>TEST PIT NUMBER</b> TP 1
	<b>WESTON &amp; SAMPSON ENGINEERS, INC.</b>



**TEST PIT LOG**

PROJECT NAME/NO.	Harry Lee Cole School - ENG20-0865		<b>TEST PIT NUMBER</b> TP 1
LOCATION	Harry Lee Cole School, Boxford, MA		
CLIENT	Boxford, MA		GROUND SURFACE
CONTRACTOR	RE Thompson	FOREMAN:	ELEVATION <u>see plan</u>
OBSERVED BY	K. Elmy	DATE	1/20/21
CHECKED BY		DATE	
			DEPTH TO GROUNDWATER BELOW SURFACE <u>48-in</u>

DEPTH BELOW GROUND SURFACE (in.)	TEST PIT DIAGRAM AND SOIL DESCRIPTION
----------------------------------	---------------------------------------



<b>NOTES:</b> 1. Redox encountered at 48-in 2. Weeping at 75-in 3. PID = 0.0PPM	<b>TEST PIT NUMBER</b> TP 1
	<b>WESTON &amp; SAMPSON</b> <b>ENGINEERS, INC.</b>

**TEST PIT LOG**

PROJECT NAME/NO.	Harry Lee Cole School - ENG20-0865	<b>TEST PIT NUMBER</b> TP 2
LOCATION	Harry Lee Cole School, Boxford, MA	
CLIENT	Boxford, MA	GROUND SURFACE
CONTRACTOR	RE Thompson	FOREMAN: _____
OBSERVED BY	K. Elmy	DATE
CHECKED BY	_____	DATE
		ELEVATION
		DEPTH TO GROUNDWATER BELOW
		SURFACE

DEPTH BELOW GROUND SURFACE (in.)	TEST PIT DIAGRAM AND SOIL DESCRIPTION
12"	Ap - Dark Brown Sandy Loam (10YR 3/3) 5% Gravel & 5% Cobbles
14"	Bw - Dark Yellowish Brown Sandy Loam (10YR 4/6) 10% Gravel & 10% Cobbles
90"	C1 - Brownish Yellow Loamy Sand (10YR 6/6) 5% Gravel & 5% Cobbles
	- End of Exploration -

<b>NOTES:</b> 1. No Redox encountered 2. PID = 1.0PPM at 2-ft intervals 3. Buried telephone pole at 12-in	<b>TEST PIT NUMBER</b> TP 2
	<b>WESTON &amp; SAMPSON ENGINEERS, INC.</b>

**TEST PIT LOG**

PROJECT NAME/NO.	Harry Lee Cole School - ENG20-0865	<b>TEST PIT NUMBER</b>	
LOCATION	Harry Lee Cole School, Boxford, MA	TP 2	
CLIENT	Boxford, MA	GROUND SURFACE	
CONTRACTOR	RE Thompson	FOREMAN:	see plan
OBSERVED BY	K. Elmy	DATE	1/20/21
CHECKED BY		DATE	
		DEPTH TO GROUNDWATER BELOW SURFACE	
		Not Observed	

DEPTH BELOW GROUND SURFACE (in.)	TEST PIT DIAGRAM AND SOIL DESCRIPTION
----------------------------------	---------------------------------------



**NOTES:**

1. No Redox encountered
2. PID = 1.0PPM at 2-ft intervals
3. Buried telephone pole at 12-in

<b>TEST PIT NUMBER</b>
TP 2
<b>WESTON &amp; SAMPSON ENGINEERS, INC.</b>

**TEST PIT LOG**

PROJECT NAME/NO.	Harry Lee Cole School - ENG20-0865	<b>TEST PIT NUMBER</b>	
LOCATION	Harry Lee Cole School, Boxford, MA	TP 3	
CLIENT	Boxford, MA	GROUND SURFACE	
CONTRACTOR	RE Thompson	FOREMAN:	see plan
OBSERVED BY	K. Elmy	DATE	1/19/21
CHECKED BY		DATE	
		DEPTH TO GROUNDWATER BELOW SURFACE	
		Not Observed	

DEPTH BELOW GROUND SURFACE (in.)	TEST PIT DIAGRAM AND SOIL DESCRIPTION
55"	PavementFill 10% Gravel & 10% Cobbles
66"	Ab - Dark Brown Sandy Loam (10YR 3/3) 10% Gravel & 10% Cobbles
76"	Bw - Dark Yellowish Brown Sandy Loam (10YR 4/6) 10% Gravel & 10% Cobbles
90"	C1 - Brownish Yellow Loamy Sand (10YR 6/6) 5% Gravel & 5% Cobbles
	- End of Exploration -

<b>NOTES:</b> 1. No Redox encountered 2. PID = 0.0PPM	<b>TEST PIT NUMBER</b>
	TP 3
	<b>WESTON &amp; SAMPSON ENGINEERS, INC.</b>

**TEST PIT LOG**

PROJECT NAME/NO.	Harry Lee Cole School - ENG20-0865		<b>TEST PIT NUMBER</b> TP 3
LOCATION	Harry Lee Cole School, Boxford, MA		
CLIENT	Boxford, MA		GROUND SURFACE
CONTRACTOR	RE Thompson	FOREMAN:	ELEVATION <u>see plan</u>
OBSERVED BY	K. Elmy	DATE	1/19/21
CHECKED BY		DATE	
			DEPTH TO GROUNDWATER BELOW SURFACE <u>Not Observed</u>

DEPTH BELOW  
GROUND  
SURFACE (in.)

TEST PIT DIAGRAM AND SOIL DESCRIPTION



**NOTES:**

1. No Redox encountered
2. PID = 0.0PPM

**TEST PIT NUMBER**

TP 3

**WESTON & SAMPSON  
ENGINEERS, INC.**

<b>TEST PIT LOG</b>			
PROJECT NAME/NO.	Harry Lee Cole School - ENG20-0865		<b>TEST PIT NUMBER</b> TP 4
LOCATION	Harry Lee Cole School, Boxford, MA		
CLIENT	Boxford, MA		GROUND SURFACE
CONTRACTOR	RE Thompson	FOREMAN:	ELEVATION see plan
OBSERVED BY	K. Elmy	DATE	1/19/21
CHECKED BY		DATE	
			DEPTH TO GROUNDWATER BELOW SURFACE Not Observed
DEPTH BELOW GROUND SURFACE (in.)	TEST PIT DIAGRAM AND SOIL DESCRIPTION		
16"	Fill		
20"	Ab - Dark Brown Sandy Loam (10YR 3/3) 10% Gravel & 10% Cobbles		
25"	Bw - Dark Yellowish Brown Sandy Loam (10YR 4/4) 10% Gravel & 10% Cobbles		
84"	C1 - Yellowish Brown Loamy Sand (10YR 5/6) 5% Gravel & 5% Cobbles		
	- End of Exploration -		
<b>NOTES:</b> 1. No Redox encountered 2. PID = 0.0PPM			<b>TEST PIT NUMBER</b> TP 4
			<b>WESTON &amp; SAMPSON ENGINEERS, INC.</b>

**TEST PIT LOG**

PROJECT NAME/NO.	Harry Lee Cole School - ENG20-0865		<b>TEST PIT NUMBER</b> TP 4
LOCATION	Harry Lee Cole School, Boxford, MA		
CLIENT	Boxford, MA		GROUND SURFACE
CONTRACTOR	RE Thompson	FOREMAN:	ELEVATION <u>see plan</u>
OBSERVED BY	K. Elmy	DATE	1/19/21
CHECKED BY		DATE	
			DEPTH TO GROUNDWATER BELOW SURFACE <u>Not Observed</u>

DEPTH BELOW  
GROUND  
SURFACE (in.)

**TEST PIT DIAGRAM AND SOIL DESCRIPTION**



**NOTES:**

1. No Redox encountered
2. PID = 0.0PPM

**TEST PIT NUMBER**

TP 4

**WESTON & SAMPSON  
ENGINEERS, INC.**

**TEST PIT LOG**

PROJECT NAME/NO.	Harry Lee Cole School - ENG20-0865	<b>TEST PIT NUMBER</b> TP 5
LOCATION	Harry Lee Cole School, Boxford, MA	
CLIENT	Boxford, MA	GROUND SURFACE
CONTRACTOR	RE Thompson	FOREMAN: see plan
OBSERVED BY	K. Elmy	DATE 1/19/21
CHECKED BY		DATE
		DEPTH TO GROUNDWATER BELOW SURFACE
		Not Observed

DEPTH BELOW GROUND SURFACE (in.)	TEST PIT DIAGRAM AND SOIL DESCRIPTION
22"	Fill 10% Gravel & 10% Cobbles
28"	Ab - Dark Brown Sandy Loam (10YR 3/3) 10% Gravel & 10% Cobbles
38"	Bw - Dark Yellowish Brown Sandy Loam (10YR 4/6) 10% Gravel & 10% Cobbles
72"	C1 - Brown Loamy Sand (10YR 5/3) 5% Gravel & 5% Cobbles
	- End of Exploration -

<b>NOTES:</b> 1. No Redox encountered 2. PID = 0.0PPM	<b>TEST PIT NUMBER</b> TP 5
	<b>WESTON &amp; SAMPSON ENGINEERS, INC.</b>



**TEST PIT LOG**

PROJECT NAME/NO.	Harry Lee Cole School - ENG20-0865		<b>TEST PIT NUMBER</b> TP 5
LOCATION	Harry Lee Cole School, Boxford, MA		
CLIENT	Boxford, MA		GROUND SURFACE
CONTRACTOR	RE Thompson	FOREMAN:	ELEVATION see plan
OBSERVED BY	K. Elmy	DATE	1/19/21
CHECKED BY		DATE	
			DEPTH TO GROUNDWATER BELOW SURFACE Not Observed

DEPTH BELOW GROUND SURFACE (in.)	TEST PIT DIAGRAM AND SOIL DESCRIPTION
----------------------------------	---------------------------------------



**NOTES:**

1. No Redox encountered
2. PID = 0.0PPM

<b>TEST PIT NUMBER</b> TP 5
<b>WESTON &amp; SAMPSON ENGINEERS, INC.</b>

**TEST PIT LOG**

PROJECT NAME/NO.	Harry Lee Cole School - ENG20-0865	<b>TEST PIT NUMBER</b> TP 6
LOCATION	Harry Lee Cole School, Boxford, MA	
CLIENT	Boxford, MA	GROUND SURFACE
CONTRACTOR	RE Thompson	FOREMAN: _____
OBSERVED BY	K. Elmy	DATE 1/19/21
CHECKED BY	_____	DATE _____
		ELEVATION see plan
		DEPTH TO GROUNDWATER BELOW SURFACE 46-in

DEPTH BELOW GROUND SURFACE (in.)	TEST PIT DIAGRAM AND SOIL DESCRIPTION
12"	Fill 10% Gravel & 10% Cobbles
20"	Ab - Dark Brown Sandy Loam (10YR 3/3) 10% Gravel & 10% Cobbles
27"	Bw - Dark Yellowish Brown Sandy Loam (10YR 4/6) 10% Gravel & 10% Cobbles
84"	C1 - Yellowish Brown Coarse Sand (10YR 5/4) 5% Gravel & 5% Cobbles
	- End of Exploration -

<b>NOTES:</b> 1. Redox encountered at 46-in 2. PID = 0.0PPM	<b>TEST PIT NUMBER</b> TP 6
	<b>WESTON &amp; SAMPSON ENGINEERS, INC.</b>

**TEST PIT LOG**

PROJECT NAME/NO.	Harry Lee Cole School - ENG20-0865		<b>TEST PIT NUMBER</b> TP 6
LOCATION	Harry Lee Cole School, Boxford, MA		
CLIENT	Boxford, MA		GROUND SURFACE
CONTRACTOR	RE Thompson	FOREMAN:	ELEVATION <u>see plan</u>
OBSERVED BY	K. Elmy	DATE	1/19/21
CHECKED BY		DATE	
			DEPTH TO GROUNDWATER BELOW SURFACE <u>46-in</u>

DEPTH BELOW GROUND SURFACE (in.)	TEST PIT DIAGRAM AND SOIL DESCRIPTION
----------------------------------	---------------------------------------



**NOTES:**

1. Redox encountered at 46-in
2. PID = 0.0PPM

<b>TEST PIT NUMBER</b> TP 6
<b>WESTON &amp; SAMPSON ENGINEERS, INC.</b>

May 12, 2021

Boxford Conservation Commission  
Town of Boxford  
7A Spofford Road  
Boxford, Massachusetts 01921

**Re: Stormwater Infiltration  
Spofford Pond and Harry Lee Cole Schools**

Dear Conservation Commission Members:

During a site walk on April 13, 2021, the Boxford Conservation Commission requested a letter from a Licensed Site Professional (LSP) regarding stormwater infiltration at Spofford Pond and Harry Lee Cole School properties. Weston & Sampson prepared this letter based on historical information, environmental investigations performed at the schools in 2021, and on our experience addressing infiltration issues at contaminated sites in Massachusetts. A discussion of existing conditions, recent soil and groundwater sampling results, and an LSP Opinion regarding stormwater infiltration are provided below.

#### Spofford Pond School

This property contains an elementary school building, a water supply well, paved parking and playground areas, athletic fields, and undeveloped woodlands. Beyond the property are forested and residential land to the north, the closed Boxford Sanitary Landfill to the northeast, athletic fields to the east, a forested portion of the Boxford Municipal Complex property to the south, and Spofford Road to the west. Across Spofford Road lies the Spofford Pond and its associated wetlands. Properties across Spofford Road include both forested and residential land. These areas are shown on Figure 1 - Environmental Resource Map.

In January 2021, as part of the design for the Project, Weston & Sampson collected one (1) soil sample (a composite of 9 samples from 9 paved areas) for disposal characterization analyses at a state-certified analytical laboratory. The results indicated the presence of low concentrations of many contaminants, including arsenic, which was detected at 14 milligrams per kilogram (mg/kg) and the contaminant concentrations were below the applicable Massachusetts Department of Environmental Protection (MassDEP) Reportable Concentration (RCS-1) under the Massachusetts Contingency Plan (MCP), 310 CMR 40.0000. Weston & Sampson did not collect groundwater from the property during this investigation, but we understand groundwater at the property is impacted by arsenic, which is treated and tested regularly in accordance with the regulations. In addition, based on our review of groundwater data for the Town of Boxford Landfill, we understand elevated concentrations of arsenic have been detected in several monitoring wells at the landfill.

#### Harry Lee Cole School

This property contains an elementary school building, a water supply well, the Aaron Wood administrative offices, a historical one-room schoolhouse, paved parking and playground areas, and undeveloped woodlands. Outside of the property limits is a residential property to the north, the Town of Boxford Cargill athletic fields to the northeast, forested and residential land to the east, residential land to the south, and Middleton Road to the northwest. These areas are shown on Figure 2 – Environmental Resource Map.

Similar to the Spofford Pond School site, Weston & Sampson collected one (1) soil sample (composite of soil samples from 10 locations on the paved area) for disposal characterization analyses by a state-certified

analytical laboratory. The results indicated the presence of low concentrations of several contaminants except for arsenic (25 mg/kg), which exceeded the MassDEP reportable concentration of 20 mg/kg.

To further assess the extent of arsenic contamination at the property, Weston & Sampson performed additional soil sampling in February and April 2021, and shallow groundwater sampling in April 2021. The soil sampling results, summarized in Table 1 and Figure 3, show arsenic concentrations in soil exceeding 20 mg/kg at most of the locations; however, low or background concentrations of arsenic were observed in the northwestern part of the property near B-HC-6. In addition, the results of April 2021 groundwater sampling shown in Table 2, and water supply well sampling results provided by the Tri-Town Union indicate arsenic has not been detected in water at the property.

#### LSP Opinion

Because of the presence of arsenic in soil and groundwater at the Spofford Pond School and in nearby properties, including the landfill, we do not recommend stormwater infiltration at the Spofford School property, as the infiltration could modify the groundwater flow directions and potentially re-direct contaminated groundwater to other properties. For the Harry Lee Cole School, based on the data collected (i.e., no arsenic detection in groundwater and low concentrations of arsenic in soil near B-HC-6), we do not have any reservations with stormwater infiltration, provided it is performed in front of the school near B-HC-6.

Should you have any questions or need additional information, please do not hesitate to contact me at (978) 532-1900 or [bhuniap@wseinc.com](mailto:bhuniap@wseinc.com).

Sincerely,

WESTON & SAMPSON ENGINEERS, INC.



Prasanta K. Bhunia, Ph.D., LSP  
Principal

Attachments: Figure 1 – Spofford Pond School Environmental Resource Map  
Figure 2 – Harry Lee Cole School Environmental Resource Map  
Figure 3 – Plan Showing Arsenic Concentrations Harry Lee Cole School  
Table 1 – Arsenic in Soil Harry Lee Cole School  
Table 2 – Groundwater Analytical Results Harry Lee Cole School

\\wse03.local\WSE\Projects\MA\Boxford MA\ENG20-0865 Cole and Spofford Schools Site\06 Submissions\02 Permitting Submissions\20210514 Revised ZBA & Con Com Submission\Infiltration Opinion Letter\Boxford 2021-05-10 Draft - Infiltration Letter to Con Com.docx

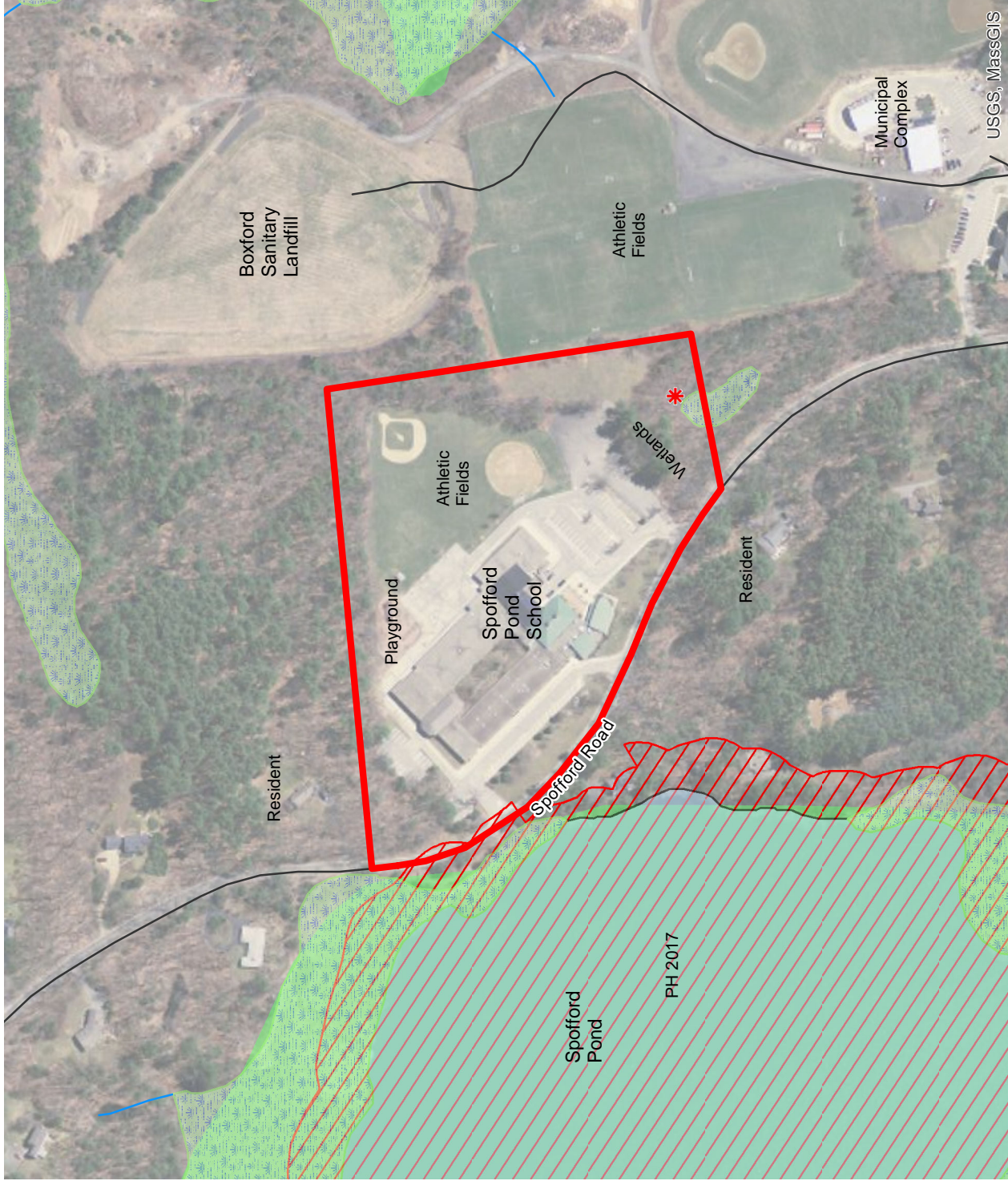

- Legend**
- Spofford Pond School
  - Hydrologic Connection
  - Perennial Stream
  - Intermittent Stream
  - Marsh/Bog
  - Wooded marsh
  - Cranberry Bog
  - Salt Marsh
  - Open Water
  - Reservoir (with PWSID)
  - Tidal Flats
  - Beach/Dune
  - ACECs
  - ACECs
  - NHESP Habitats
  - NHESP Estimated Habitats of Rare Wildlife
  - NHESP Priority Habitats of Rare Species
  - NHESP Certified Vernal Pools
  - NHESP Potential Vernal Pools
  - NHESP Potential Vernal Pools
- FEMA National Flood Hazard Layer**
- Flood Zone Designations**
- A: 1% Annual Chance of Flooding, no BFE
  - AE: 1% Annual Chance of Flooding, with BFE
  - AE: Regulatory Floodway
  - AH: 1% Annual Chance of 1-3ft Ponding, with BFE
  - AO: 1% Annual Chance of 1-3ft Sheet Flow Flooding, with Depth
  - VE: High Risk Coastal Area
  - D: Possible But Undetermined Hazard
  - X: 0.2% Annual Chance of Flooding
  - X: Reduced Flood Risk due to Levee
  - Area Not Included
  - Area with no DFIRM - Paper FIRMs in Effect
- Outstanding Resource Waters**
- Public Water Supply Contributor
  - ORW for ACEC
  - ORW for both Water Supply and Other

**FIGURE 1**  
**Spofford Pond School**  
**Boxford, MA**  
**Environmental**  
**Resource Map**

**Data Source:** Office of Geographic and Environmental Information (MassGIS), Commonwealth of Massachusetts Executive Office of Environmental Affairs

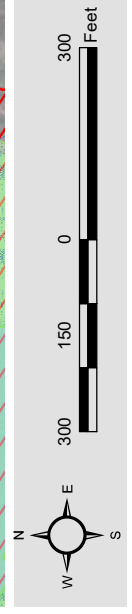

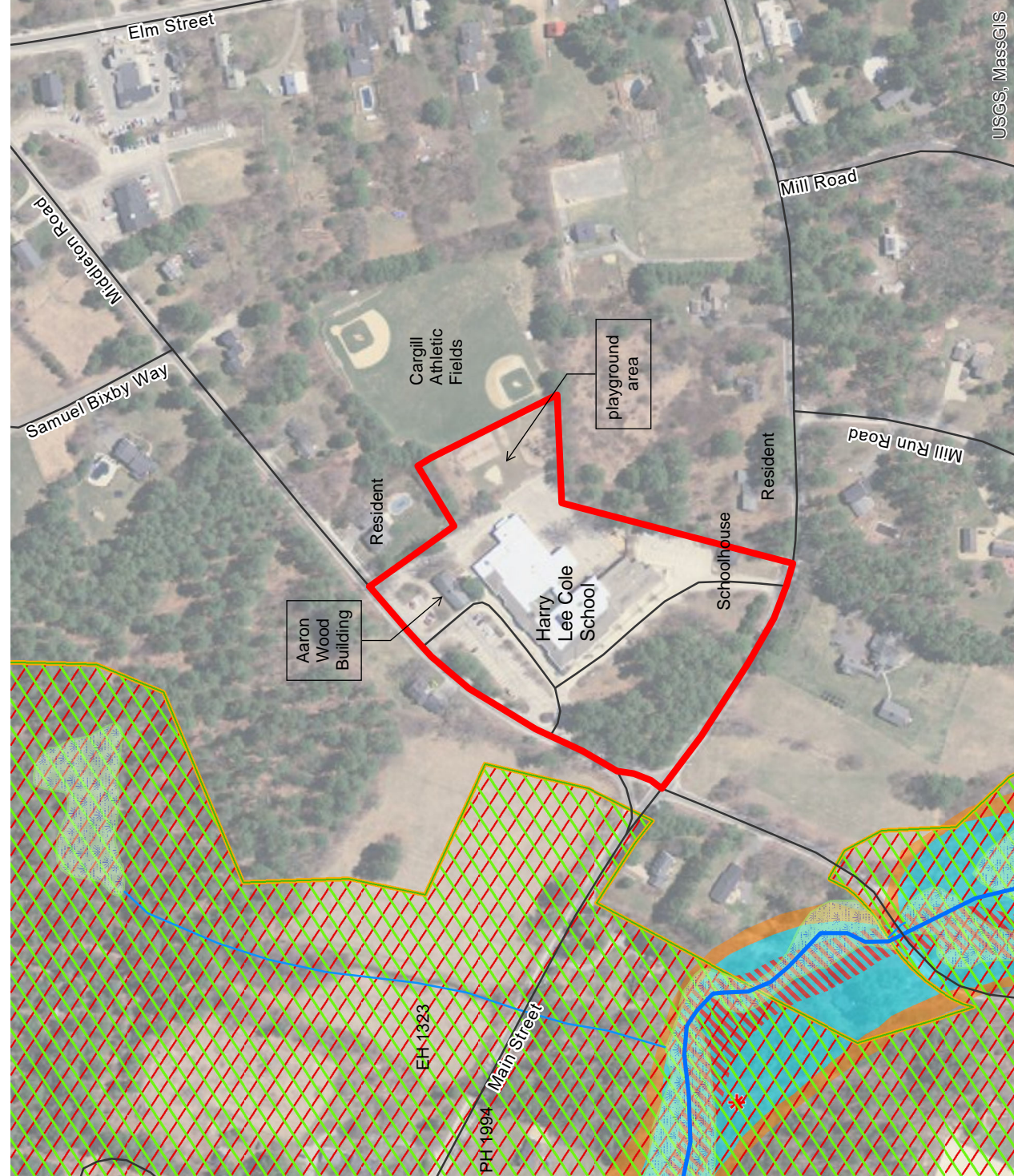

**Legend**

- Harry Lee Cole School
- Hydrologic Connection
- Perennial Stream
- Intermittent Stream
- Marsh/Bog
- Wooded marsh
- Cranberry Bog
- Salt Marsh
- Open Water
- Reservoir (with PWSID)
- Tidal Flats
- Beach/Dune
- ACECs
- ACECs
- NHESP Habitats
- NHESP Estimated Habitats of Rare Wildlife
- NHESP Priority Habitats of Rare Species
- NHESP Certified Vernal Pools
- NHESP Potential Vernal Pools

**FEMA National Flood Hazard Layer**

**Flood Zone Designations**

- A: 1% Annual Chance of Flooding, no BFE
- AE: 1% Annual Chance of Flooding, with BFE
- AE: Regulatory Floodway
- AH: 1% Annual Chance of 1-3ft Ponding, with BFE
- AO: 1% Annual Chance of 1-3ft Sheet Flow Flooding, with Depth
- VE: High Risk Coastal Area
- D: Possible But Undetermined Hazard
- X: 0.2% Annual Chance of Flooding
- X: Reduced Flood Risk due to Levee
- Area Not Included
- Area with no DFIRM - Paper FIRMs in Effect

**Outstanding Resource Waters**

- Public Water Supply Contributor
- ORW for ACEC
- ORW for both Water Supply and Other

**FIGURE 2**  
**Harry Lee Cole School**  
**Boxford, MA**  
**Environmental**  
**Resource Map**



**Data Source:** Office of Geographic and Environmental Information (MassGIS), Commonwealth of Massachusetts Executive Office of Environmental Affairs

USGS, MassGIS

**Revisions:**

No.	Date	Description

**Issues For:**

PERMITTING ONLY NOT FOR CONSTRUCTION	
Scale:	AS SHOWN
Date:	APRIL 7, 2021
Drawn By:	EJA
Reviewed By:	CB
Approved By:	JJP
W&S Project No.:	ENG20-0865
W&S File No.:	

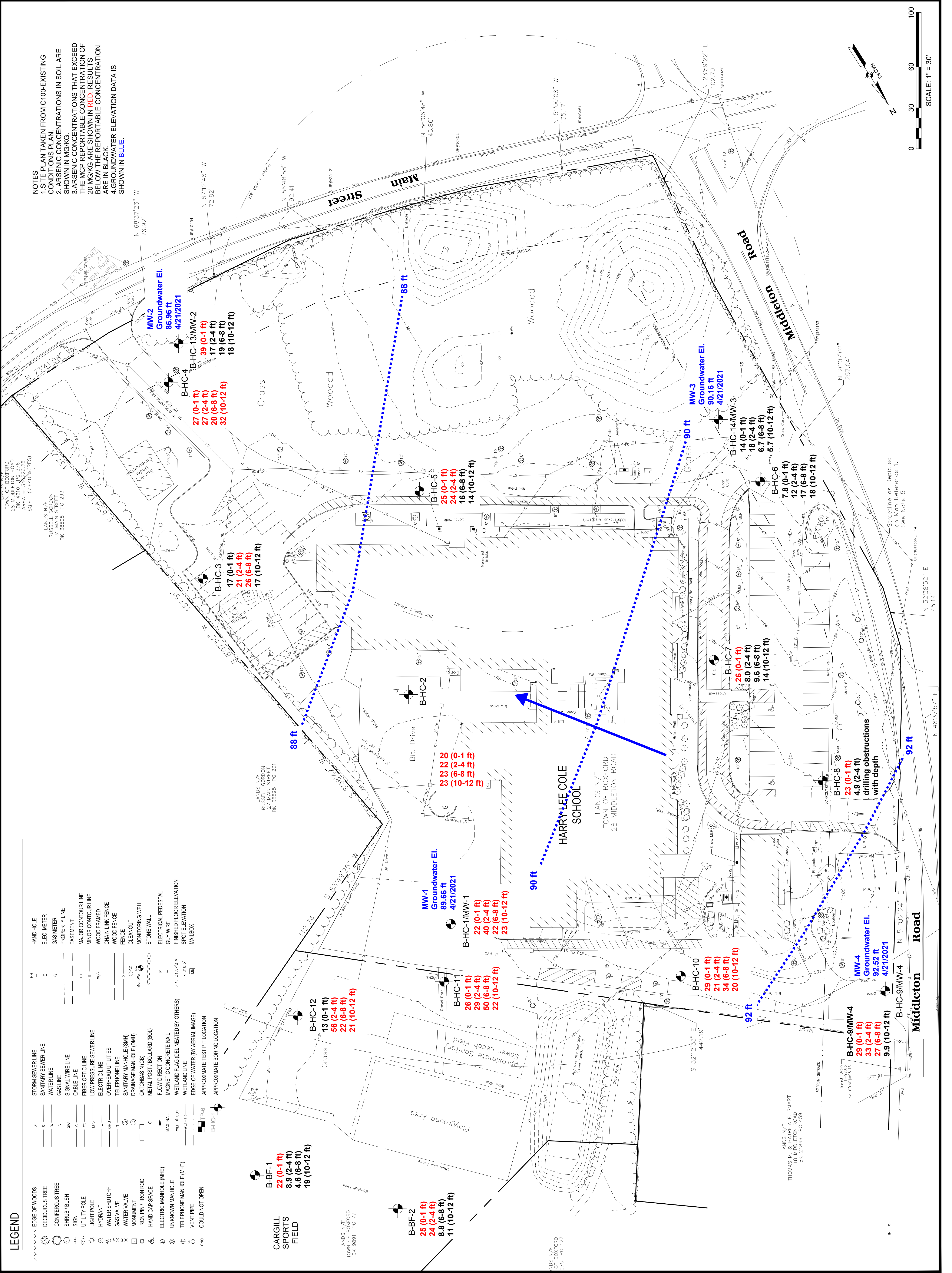

**NOTES**  
 1. SITE PLAN TAKEN FROM C100-EXISTING CONDITIONS PLAN.  
 2. ARSENIC CONCENTRATIONS IN SOIL ARE SHOWN IN MG/KG.  
 3. ARSENIC CONCENTRATIONS THAT EXCEED THE MCP REPORTABLE CONCENTRATION OF 20 MG/KG ARE SHOWN IN RED. RESULTS BELOW THE REPORTABLE CONCENTRATION ARE IN BLACK.  
 4. GROUNDWATER ELEVATION DATA IS SHOWN IN BLUE.

**LEGEND**

	STORM SEWER LINE		HAND HOLE
	SANITARY SEWER LINE		ELEC. METER
	WATER LINE		GAS METER
	GAS LINE		PROPERTY LINE
	SIGNAL WIRE LINE		MAJOR CONTOUR LINE
	CABLE WIRE LINE		MINOR CONTOUR LINE
	FIBER OPTIC LINE		WOOD FRAMED FENCE
	LOW PRESSURE SEWER LINE		CHAIN LINK FENCE
	ELECTRIC LINE		WOOD FENCE
	OVERHEAD UTILITIES		FENCE
	TELEPHONE LINE		SANITARY MANHOLE (SMH)
	TELEPHONE MANHOLE (MHT)		DRAINAGE MANHOLE (DMH)
	VENT PIPE		CATCH BASIN (CB)
	COULD NOT OPEN		METAL POST / BOLLARD (BOL)
	EDGE OF WOODS		FLOW DIRECTION
	DECIDUOUS TREE		WETLAND FLAG (DELIMITED BY OTHERS)
	CONIFEROUS TREE		EDGE OF WATER (BY AERIAL IMAGE)
	SHRUB / BUSH		APPROXIMATE TEST PIT LOCATION
	SIGN		APPROXIMATE BORING LOCATION
	UTILITY POLE		
	LIGHT POLE		
	HYDRANT		
	WATER SHUTOFF		
	WATER VALVE		
	MONUMENT		
	HANDICAP SPACE		
	ELECTRIC MANHOLE (MHE)		
	UNKNOWN MANHOLE		
	TELEPHONE MANHOLE (MHT)		



Table 1  
Arsenic Concentrations in Soil  
2/18/2021 and 4/15-16/2021

Harry Lee Cole School  
26 Middleton Road  
Boxford, Massachusetts

Parameter	Sample depth (feet below pavement or ground)	MCP Reportable Concentration (RCS-1)	Comm 97 Levels for Soil		Sample Location and Concentration in mg/kg																	
			Lined Landfill	Reuse Unlined Landfill	B-HC-1	B-HC-2	B-HC-3	B-HC-4	B-HC-5	B-HC-6	B-HC-7	B-HC-8	B-HC-9	B-HC-10	B-HC-11	B-HC-12	B-HC-13	B-HC-14				
					/MW-1	/MW-2	/MW-3	/MW-4	/MW-2	/MW-3	/MW-2	/MW-3	/MW-2	/MW-3	/MW-2	/MW-3	/MW-2	/MW-3	/MW-2	/MW-3		
Arsenic	0 - 1	20	40	40	22	20	17	27	18	25	7.8	26	23	29	29	29	26	13	39	14	22	25
	2 - 4	20	40	40	40	22	21	27	~	24	12	8.0	4.9	33	21	29	56	17	18	18	8.9	24
	6 - 8	20	40	40	40	22	23	26	~	16	17	9.6	NA*	27	34	50	22	19	6.7	6.7	4.6	8.8
	10 - 12	20	40	40	40	23	23	17	32	14	18	14	NA*	9.9	20	22	21	18	5.7	5.7	19	11

NOTES:

- MCP is the Massachusetts Contingency Plan, 310 CMR, 40.0000
- Concentrations at or above the Reportable Concentration (RCS-1) require 120-day notification to the MassDEP under the MCP.
- Comm 97 levels are from MassDEP policy COMM-97-001, 'Reuse and Disposal of Contaminated Soil at Massachusetts Landfills'
- Samples B-HC-1 through B-HC-10 from 0-1 foot and 2-4 foot were collected on 2/18/2021. The remaining samples were collected on 4/15/2021 and 4/16/2021. \*B-BF-# samples were collected from the adjacent ballfield.

NA\* Obstructions were encountered during drilling which prohibited sampling at these depths.

**BOLD** Results are equal to or greater than the MCP Reportable Concentration (RCS-1)

Table 2  
Groundwater Analytical Results  
April 21, 2021

Harry Lee Cole School  
26 Middleton Road  
Boxford, Massachusetts

Parameter	Units	MCP Reportable Concentration		Sample Location			
		RCGW-1	RCGW-2	MW-1	MW-2	MW-3	MW-4
Dissolved Arsenic	ug/L	10	900	<0.80	<0.80	<0.80	<0.80

NOTES:

1. MCP is the Massachusetts Contingency Plan, 310 CMR 40.0000
  2. Concentrations at or above the Reportable Concentration (RCGW-1 or RCGW-2) require 120-day notification to the MassDEP under the MCP.
  3. Dissolved samples were field-filtered.
- ug/L = micrograms per liter, or parts per billion

## **Attachment D - HydroCAD Reports**

Harry Lee Cole School  
 Boxford, MA  
 Stormwater Discharge Summary Table  
 6-Jul-21

Analysis Point	24 Hr Storm	Peak Discharge (cfs)	
		Pre	Post
A	2yr	6.62	4.30
	10yr	14.62	11.11
	25yr	20.67	16.32
	50yr	28.12	22.52
	100yr	35.17	31.24
B	2yr	0.45	0.03
	10yr	0.91	0.16
	25yr	1.25	0.27
	50yr	1.65	0.41
	100yr	2.02	0.56

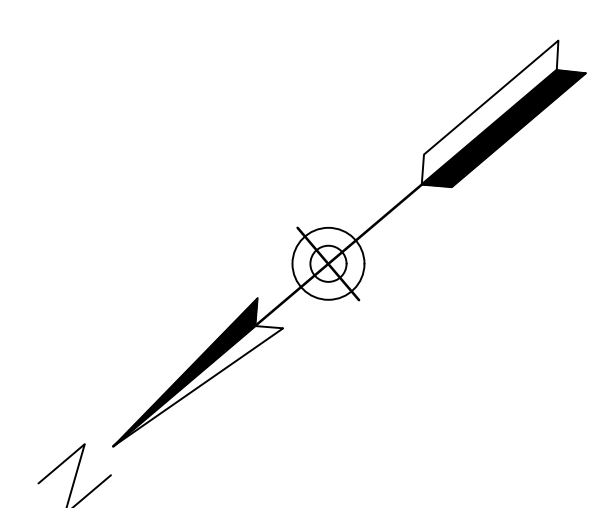

- LEGEND**
- IMPERVIOUS
  - WOODLAND
  - GRASSED/LANDSCAPE AREAS

Project:  
**BOXFORD PUBLIC SCHOOLS SITE RENOVATION PROJECT**



TOWN OF BOXFORD, MA

**Weston & Sampson**  
 Weston & Sampson Engineers, Inc.  
 55 Walkers Brook Drive, Suite 100  
 Reading, MA 01867  
 978.532.1900 800.SAMPSON  
 www.westonandsampson.com

Consultants:

Revisions:

No.	Date	Description
1	04/01/21	PER TOWN REVIEW
2	07/06/21	PER PEER REVIEW
3	08/24/21	PER REVISED LAYOUT

Scale:  
 AS NOTED

Issued For:  
**PERMITTING NOT FOR CONSTRUCTION**

Date: FEBRUARY 3, 2021  
 Drawn By: AKG  
 Reviewed By: JIP  
 Approved By: JRF

W&S Project No.: ENG20-0865  
 W&S File No.:

Drawing Title:  
**EXISTING HYDROLOGIC MAP**

Sheet Number:  
**FIG-1**

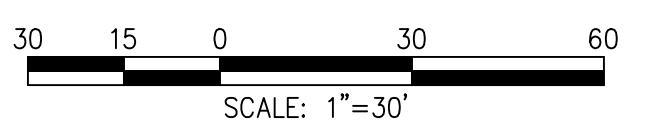
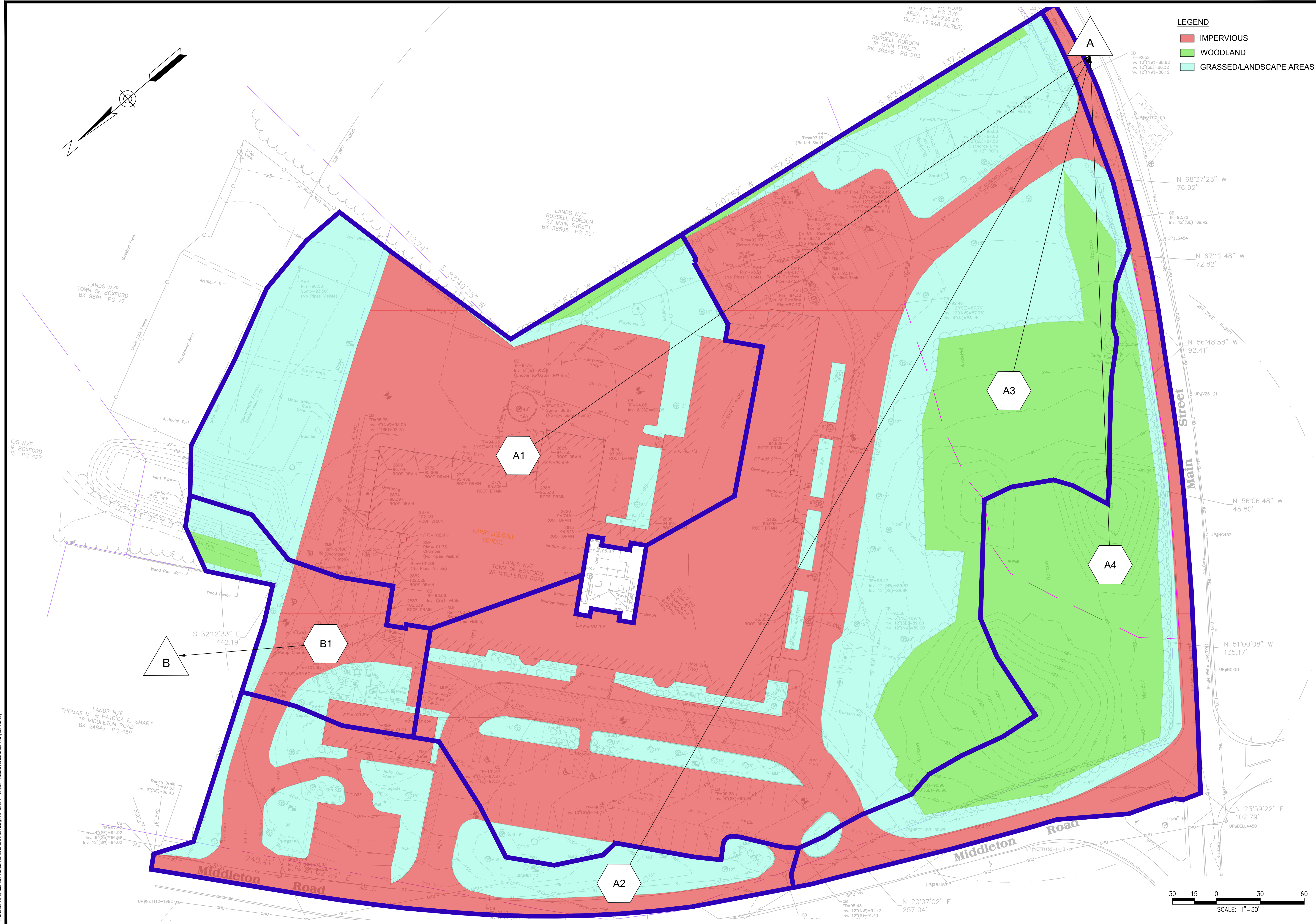

Rev. 1.3 Date: 10/24/2019

Consultants:

Revisions:

No.	Date	Description
1	04/01/21	PER TOWN REVIEW
2	07/06/21	PER PEER REVIEW
3	08/24/21	PER REVISED LAYOUT
4	11/01/21	PER PEER REVIEW

Seal:

Issued For:  
**PERMITTING NOT FOR CONSTRUCTION**

Scale: AS NOTED  
 Date: FEBRUARY 3, 2021  
 Drawn By: AKG  
 Reviewed By: JIP  
 Approved By: JRF

W&S Project No.: ENG20-0865  
 W&S File No.:

Drawing Title:  
**PROPOSED HYDROLOGIC MAP**

Sheet Number:  
**FIG-2**

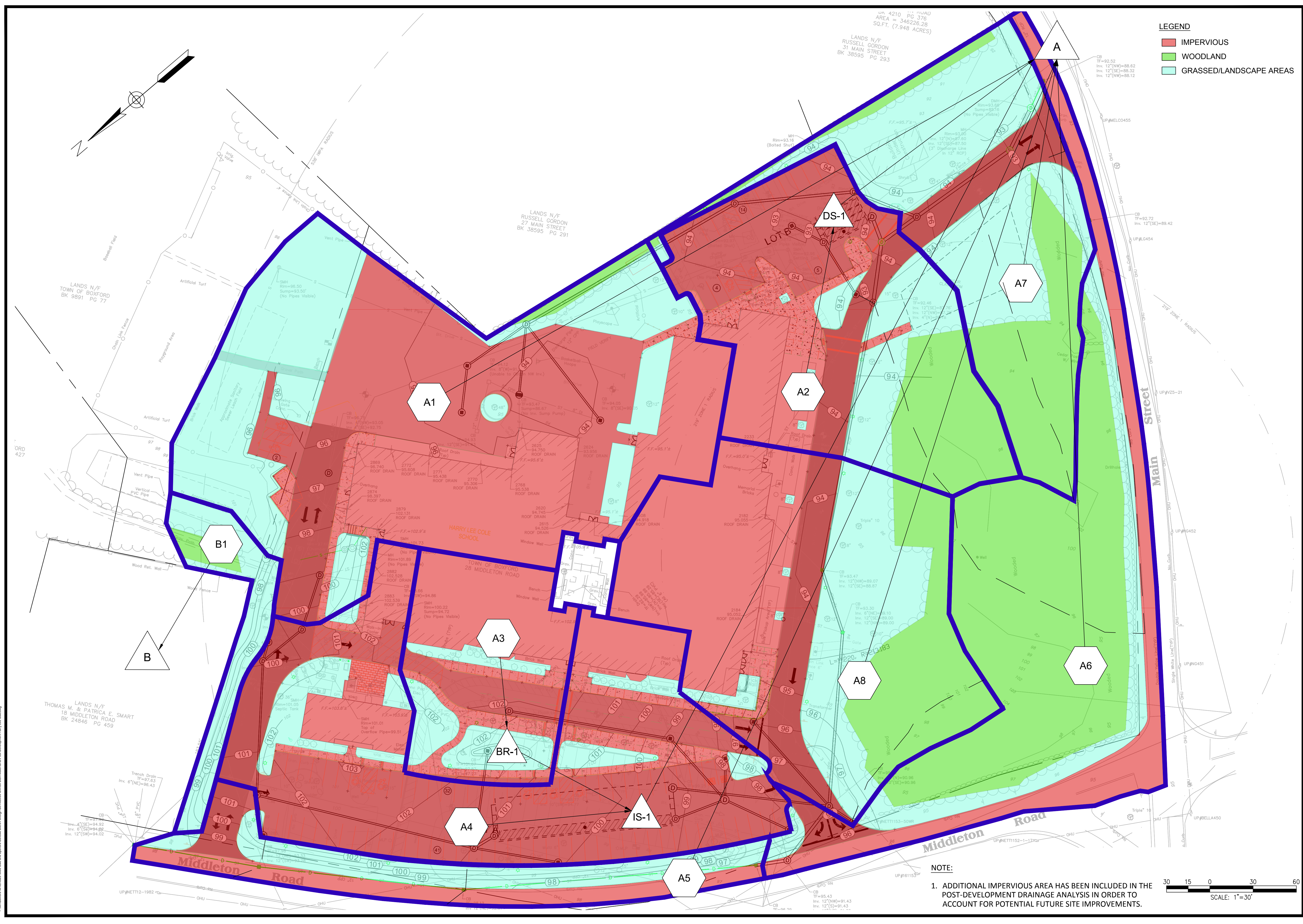

**LEGEND**  
 IMPERVIOUS  
 WOODLAND  
 GRASSED/LANDSCAPE AREAS

**NOTE:**  
 1. ADDITIONAL IMPERVIOUS AREA HAS BEEN INCLUDED IN THE POST-DEVELOPMENT DRAINAGE ANALYSIS IN ORDER TO ACCOUNT FOR POTENTIAL FUTURE SITE IMPROVEMENTS.

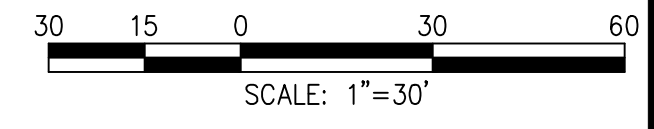

P:\Projects\182020\182020-0865\_Cole and Sampson School Shared Design Services\03 Civils\Schematic\CD\HydroDevelopment\HydroMap.dwg  
 Date: 10/24/2019  
 Rev: 1.8

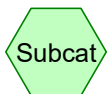
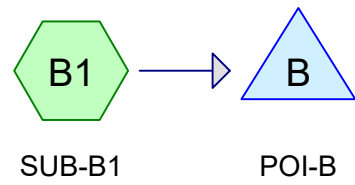
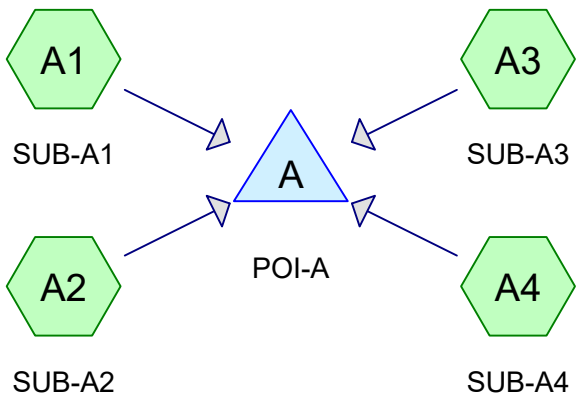

Subcat



Reach

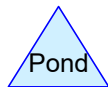

Pond



Link

## Cole Pre-Development

Prepared by Weston & Sampson

HydroCAD® 10.00-20 s/n 00455 © 2017 HydroCAD Software Solutions LLC

Printed 4/6/2021

Page 2

### Area Listing (all nodes)

Area (sq-ft)	CN	Description (subcatchment-numbers)
34,624	39	>75% Grass cover, Good, HSG A (A2, A3, A4, B1)
56,036	61	>75% Grass cover, Good, HSG B (A1, A2, A3, A4, B1)
44,718	98	Paved Impervious, HSG A (A2, A3, A4)
65,943	98	Paved Impervious, HSG B (A1, A2, A3, A4, B1)
7,434	98	Roofs, HSG A (A2, A3, B1)
38,536	98	Roofs, HSG B (A1, A3)
33,603	30	Woods, Good, HSG A (A3, A4)
21,852	55	Woods, Good, HSG B (A1, A3, A4, B1)
<b>302,746</b>	<b>74</b>	<b>TOTAL AREA</b>



# Cole Pre-Development

Prepared by Weston & Sampson

HydroCAD® 10.00-20 s/n 00455 © 2017 HydroCAD Software Solutions LLC

Printed 4/6/2021

Page 3

## Soil Listing (all nodes)

Area (sq-ft)	Soil Group	Subcatchment Numbers
120,379	HSG A	A2, A3, A4, B1
182,367	HSG B	A1, A2, A3, A4, B1
0	HSG C	
0	HSG D	
0	Other	
<b>302,746</b>		<b>TOTAL AREA</b>

# Cole Pre-Development

Prepared by Weston & Sampson

HydroCAD® 10.00-20 s/n 00455 © 2017 HydroCAD Software Solutions LLC

Printed 4/6/2021

Page 4

## Ground Covers (all nodes)

HSG-A (sq-ft)	HSG-B (sq-ft)	HSG-C (sq-ft)	HSG-D (sq-ft)	Other (sq-ft)	Total (sq-ft)	Ground Cover
34,624	56,036	0	0	0	90,660	>75% Grass cover, Good
44,718	65,943	0	0	0	110,661	Paved Impervious
7,434	38,536	0	0	0	45,970	Roofs
33,603	21,852	0	0	0	55,455	Woods, Good
<b>120,379</b>	<b>182,367</b>	<b>0</b>	<b>0</b>	<b>0</b>	<b>302,746</b>	<b>TOTAL AREA</b>

## Cole Pre-Development

Prepared by Weston & Sampson

HydroCAD® 10.00-20 s/n 00455 © 2017 HydroCAD Software Solutions LLC

Type III 24-hr 2-Yr Rainfall=3.10"

Printed 4/6/2021

Page 5

Time span=1.00-36.00 hrs, dt=0.01 hrs, 3501 points x 2  
Runoff by SCS TR-20 method, UH=SCS, Weighted-CN  
Reach routing by Dyn-Stor-Ind method - Pond routing by Dyn-Stor-Ind method

**SubcatchmentA1: SUB-A1** Runoff Area=70,293 sf 66.46% Impervious Runoff Depth=1.75"  
Tc=6.0 min CN=86 Runoff=3.31 cfs 10,242 cf

**SubcatchmentA2: SUB-A2** Runoff Area=30,592 sf 58.29% Impervious Runoff Depth=1.03"  
Tc=6.0 min CN=75 Runoff=0.80 cfs 2,618 cf

**SubcatchmentA3: SUB-A3** Runoff Area=144,484 sf 50.55% Impervious Runoff Depth=0.87"  
Flow Length=152' Tc=9.3 min CN=72 Runoff=2.75 cfs 10,454 cf

**SubcatchmentA4: SUB-A4** Runoff Area=44,474 sf 26.50% Impervious Runoff Depth=0.34"  
Flow Length=463' Tc=12.7 min CN=59 Runoff=0.17 cfs 1,252 cf

**SubcatchmentB1: SUB-B1** Runoff Area=12,903 sf 56.30% Impervious Runoff Depth=1.33"  
Tc=6.0 min CN=80 Runoff=0.45 cfs 1,425 cf

**Pond A: POI-A** Inflow=6.62 cfs 24,565 cf  
Primary=6.62 cfs 24,565 cf

**Pond B: POI-B** Inflow=0.45 cfs 1,425 cf  
Primary=0.45 cfs 1,425 cf

**Total Runoff Area = 302,746 sf Runoff Volume = 25,991 cf Average Runoff Depth = 1.03"**  
**48.26% Pervious = 146,115 sf 51.74% Impervious = 156,631 sf**

**Cole Pre-Development**

Prepared by Weston & Sampson

HydroCAD® 10.00-20 s/n 00455 © 2017 HydroCAD Software Solutions LLC

Type III 24-hr 2-Yr Rainfall=3.10"

Printed 4/6/2021

Page 6

**Summary for Subcatchment A1: SUB-A1**

Runoff = 3.31 cfs @ 12.09 hrs, Volume= 10,242 cf, Depth= 1.75"

Runoff by SCS TR-20 method, UH=SCS, Weighted-CN, Time Span= 1.00-36.00 hrs, dt= 0.01 hrs  
Type III 24-hr 2-Yr Rainfall=3.10"

	Area (sf)	CN	Description
*	25,439	98	Paved Impervious, HSG B
	21,280	98	Roofs, HSG B
	22,661	61	>75% Grass cover, Good, HSG B
	913	55	Woods, Good, HSG B
	70,293	86	Weighted Average
	23,574		33.54% Pervious Area
	46,719		66.46% Impervious Area

Tc (min)	Length (feet)	Slope (ft/ft)	Velocity (ft/sec)	Capacity (cfs)	Description
6.0					Direct Entry,

**Subcatchment A1: SUB-A1**

Hydrograph

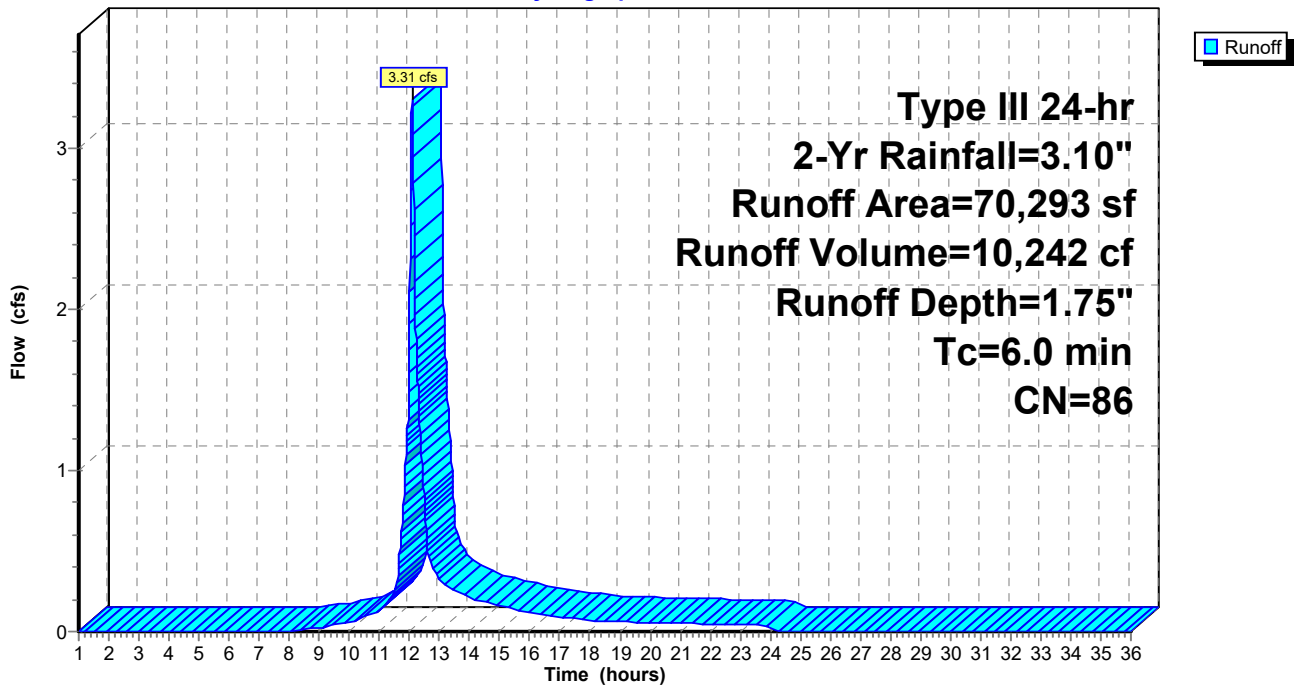

**Cole Pre-Development**

Prepared by Weston & Sampson

HydroCAD® 10.00-20 s/n 00455 © 2017 HydroCAD Software Solutions LLC

Type III 24-hr 2-Yr Rainfall=3.10"

Printed 4/6/2021

Page 7

**Summary for Subcatchment A2: SUB-A2**

Runoff = 0.80 cfs @ 12.10 hrs, Volume= 2,618 cf, Depth= 1.03"

Runoff by SCS TR-20 method, UH=SCS, Weighted-CN, Time Span= 1.00-36.00 hrs, dt= 0.01 hrs  
Type III 24-hr 2-Yr Rainfall=3.10"

	Area (sf)	CN	Description
*	14,124	98	Paved Impervious, HSG A
*	2,639	98	Paved Impervious, HSG B
	1,068	98	Roofs, HSG A
	11,139	39	>75% Grass cover, Good, HSG A
	1,622	61	>75% Grass cover, Good, HSG B
	30,592	75	Weighted Average
	12,761		41.71% Pervious Area
	17,831		58.29% Impervious Area

Tc (min)	Length (feet)	Slope (ft/ft)	Velocity (ft/sec)	Capacity (cfs)	Description
6.0					Direct Entry,

**Subcatchment A2: SUB-A2**

Hydrograph

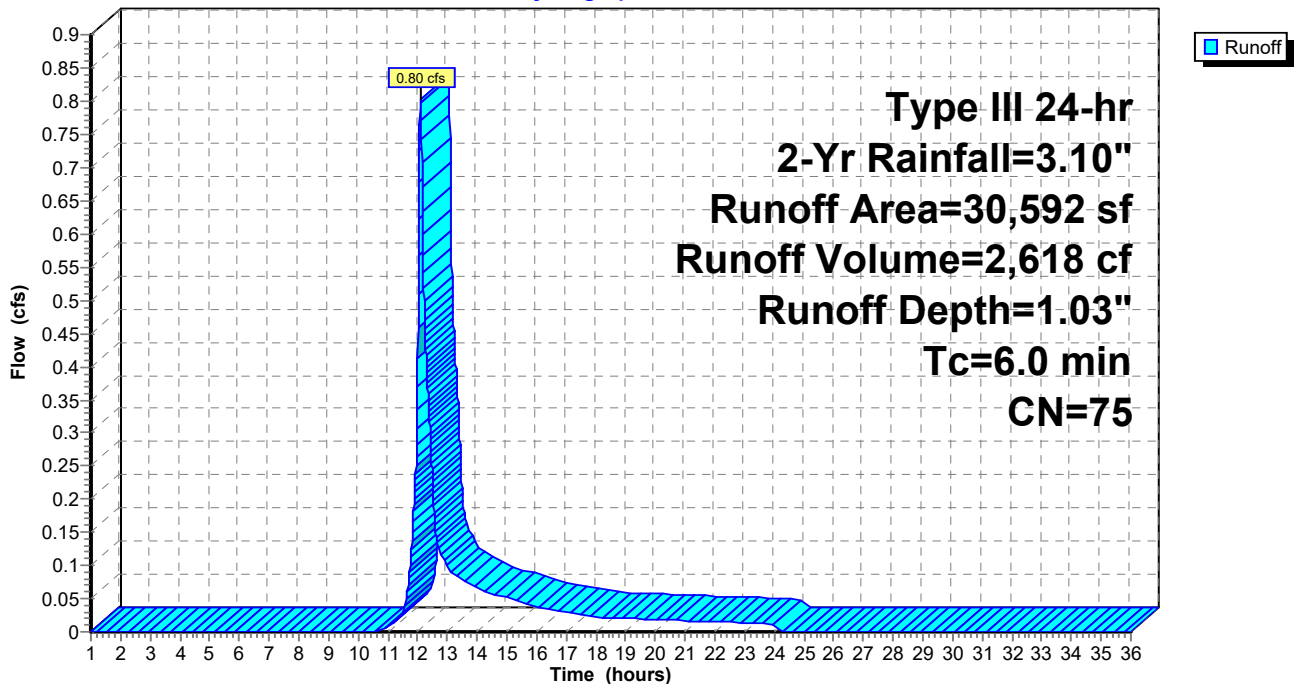

**Cole Pre-Development**

Prepared by Weston & Sampson

HydroCAD® 10.00-20 s/n 00455 © 2017 HydroCAD Software Solutions LLC

Type III 24-hr 2-Yr Rainfall=3.10"

Printed 4/6/2021

Page 8

**Summary for Subcatchment A3: SUB-A3**

Runoff = 2.75 cfs @ 12.14 hrs, Volume= 10,454 cf, Depth= 0.87"

Runoff by SCS TR-20 method, UH=SCS, Weighted-CN, Time Span= 1.00-36.00 hrs, dt= 0.01 hrs  
Type III 24-hr 2-Yr Rainfall=3.10"

Area (sf)	CN	Description
* 26,940	98	Paved Impervious, HSG A
* 23,438	98	Paved Impervious, HSG B
20,776	39	>75% Grass cover, Good, HSG A
23,581	61	>75% Grass cover, Good, HSG B
19,969	30	Woods, Good, HSG A
7,127	55	Woods, Good, HSG B
5,397	98	Roofs, HSG A
17,256	98	Roofs, HSG B
144,484	72	Weighted Average
71,453		49.45% Pervious Area
73,031		50.55% Impervious Area

Tc (min)	Length (feet)	Slope (ft/ft)	Velocity (ft/sec)	Capacity (cfs)	Description
7.8	50	0.0600	0.11		<b>Sheet Flow,</b> Woods: Light underbrush n= 0.400 P2= 3.30"
0.7	41	0.0340	0.92		<b>Shallow Concentrated Flow,</b> Woodland Kv= 5.0 fps
0.8	61	0.0340	1.29		<b>Shallow Concentrated Flow,</b> Short Grass Pasture Kv= 7.0 fps
9.3	152	Total			

**Subcatchment A3: SUB-A3**

Hydrograph

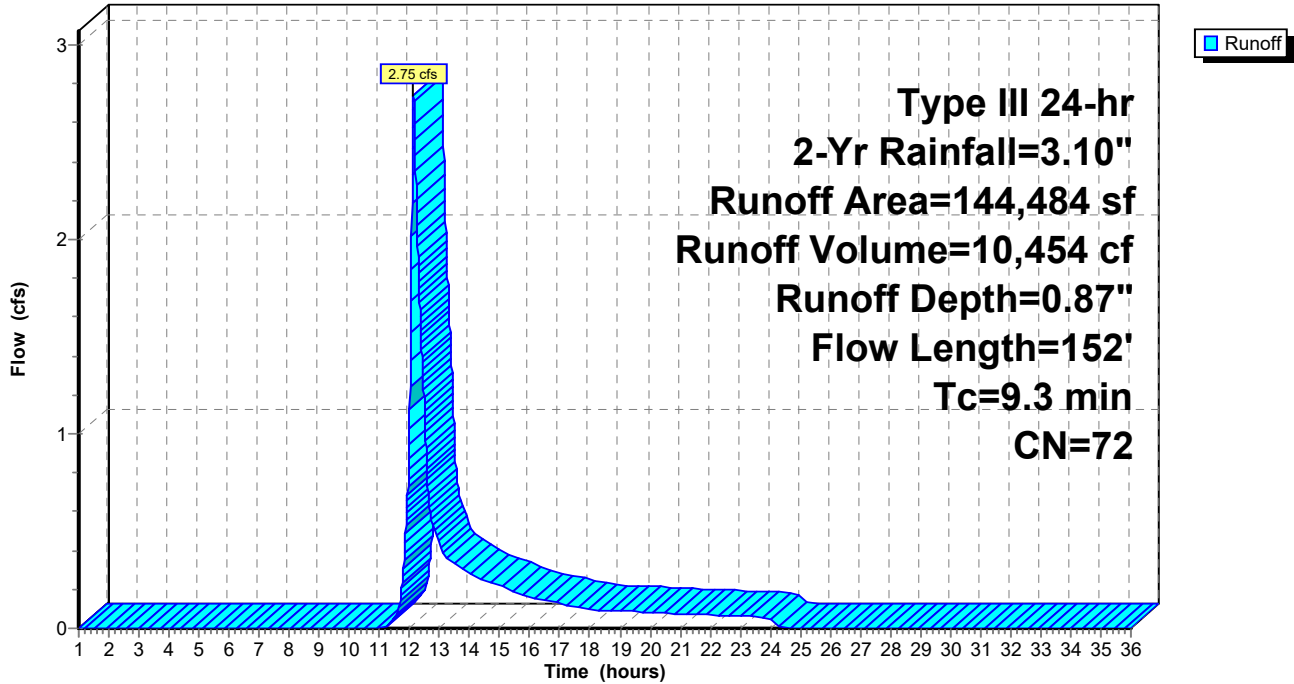

# Cole Pre-Development

Prepared by Weston & Sampson

HydroCAD® 10.00-20 s/n 00455 © 2017 HydroCAD Software Solutions LLC

Type III 24-hr 2-Yr Rainfall=3.10"

Printed 4/6/2021

Page 10

## Summary for Subcatchment A4: SUB-A4

Runoff = 0.17 cfs @ 12.35 hrs, Volume= 1,252 cf, Depth= 0.34"

Runoff by SCS TR-20 method, UH=SCS, Weighted-CN, Time Span= 1.00-36.00 hrs, dt= 0.01 hrs  
Type III 24-hr 2-Yr Rainfall=3.10"

Area (sf)	CN	Description
* 3,654	98	Paved Impervious, HSG A
* 8,132	98	Paved Impervious, HSG B
2,071	39	>75% Grass cover, Good, HSG A
3,960	61	>75% Grass cover, Good, HSG B
13,634	30	Woods, Good, HSG A
13,023	55	Woods, Good, HSG B
44,474	59	Weighted Average
32,688		73.50% Pervious Area
11,786		26.50% Impervious Area

Tc (min)	Length (feet)	Slope (ft/ft)	Velocity (ft/sec)	Capacity (cfs)	Description
7.8	50	0.0600	0.11		<b>Sheet Flow,</b> Woods: Light underbrush n= 0.400 P2= 3.30"
2.5	120	0.0250	0.79		<b>Shallow Concentrated Flow,</b> Woodland Kv= 5.0 fps
2.4	293	0.0100	2.03		<b>Shallow Concentrated Flow,</b> Paved Kv= 20.3 fps
12.7	463	Total			



**Cole Pre-Development**

Prepared by Weston & Sampson

HydroCAD® 10.00-20 s/n 00455 © 2017 HydroCAD Software Solutions LLC

Type III 24-hr 2-Yr Rainfall=3.10"

Printed 4/6/2021

Page 11

**Subcatchment A4: SUB-A4**

Hydrograph

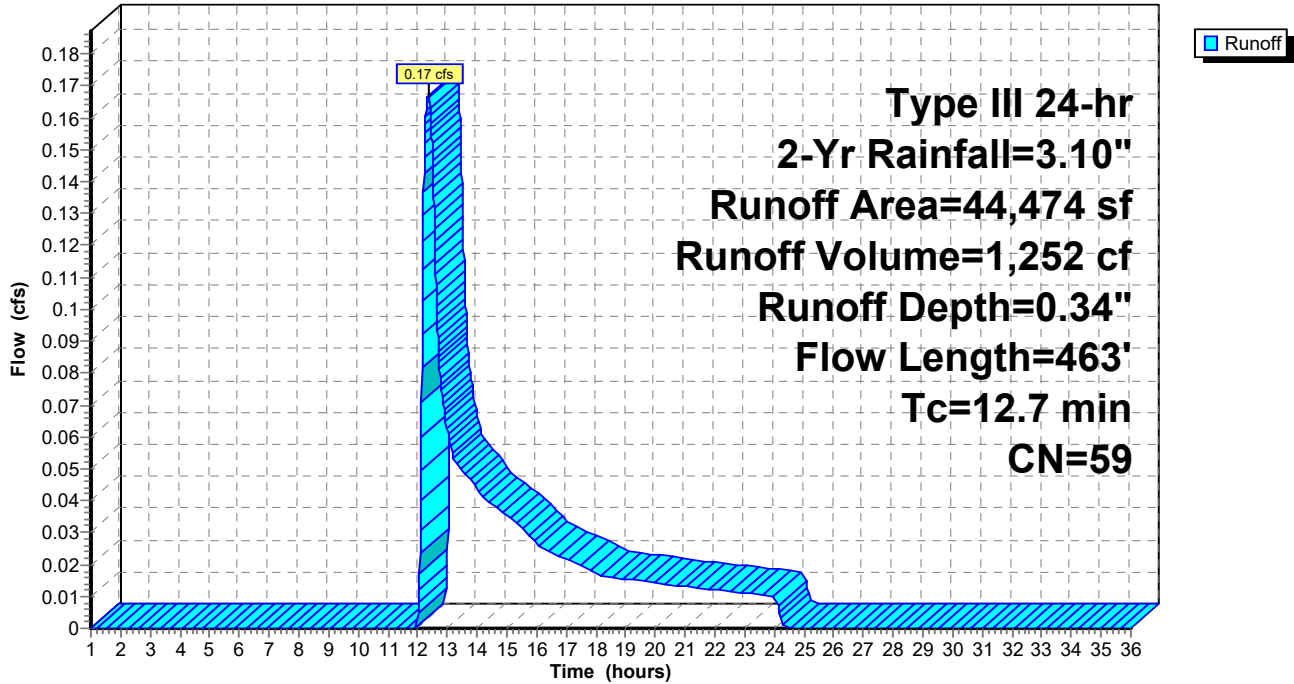

**Cole Pre-Development**

Prepared by Weston & Sampson

HydroCAD® 10.00-20 s/n 00455 © 2017 HydroCAD Software Solutions LLC

Type III 24-hr 2-Yr Rainfall=3.10"

Printed 4/6/2021

Page 12

**Summary for Subcatchment B1: SUB-B1**

Runoff = 0.45 cfs @ 12.09 hrs, Volume= 1,425 cf, Depth= 1.33"

Runoff by SCS TR-20 method, UH=SCS, Weighted-CN, Time Span= 1.00-36.00 hrs, dt= 0.01 hrs  
Type III 24-hr 2-Yr Rainfall=3.10"

	Area (sf)	CN	Description
*	6,295	98	Paved Impervious, HSG B
	969	98	Roofs, HSG A
	638	39	>75% Grass cover, Good, HSG A
	4,212	61	>75% Grass cover, Good, HSG B
	789	55	Woods, Good, HSG B
	12,903	80	Weighted Average
	5,639		43.70% Pervious Area
	7,264		56.30% Impervious Area

Tc (min)	Length (feet)	Slope (ft/ft)	Velocity (ft/sec)	Capacity (cfs)	Description
6.0					Direct Entry,

**Subcatchment B1: SUB-B1**

Hydrograph

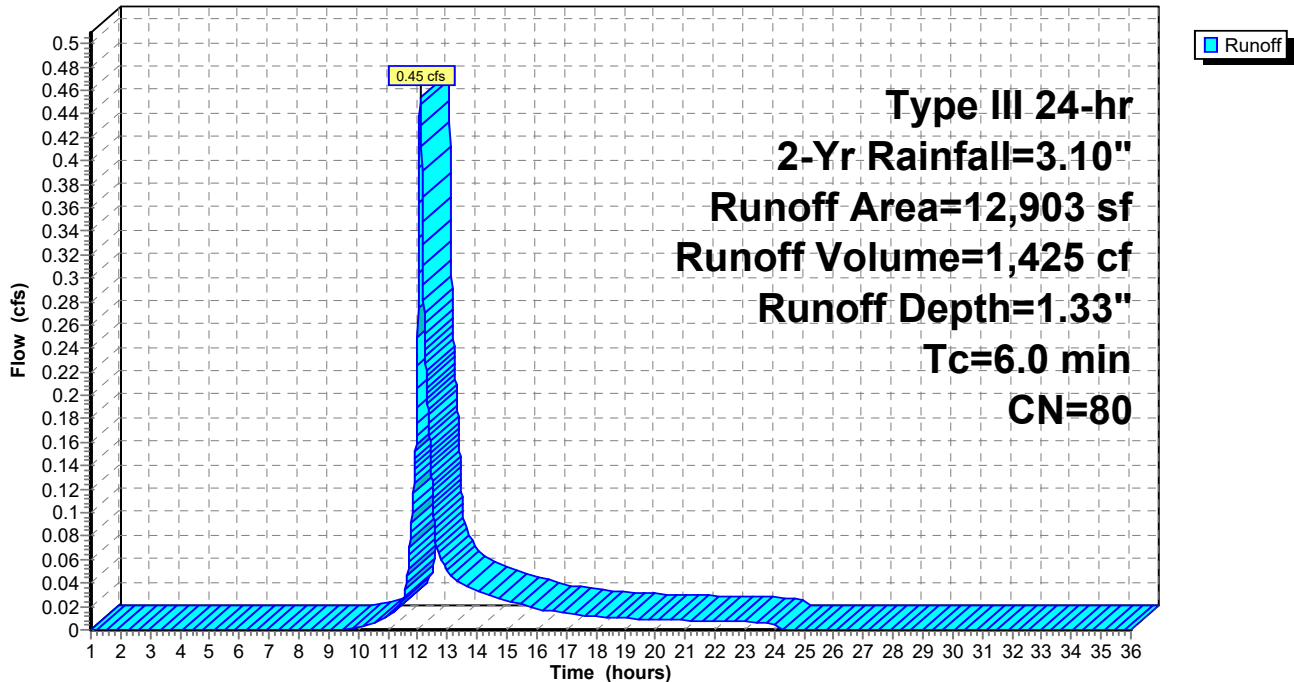

# Cole Pre-Development

Prepared by Weston & Sampson

HydroCAD® 10.00-20 s/n 00455 © 2017 HydroCAD Software Solutions LLC

Type III 24-hr 2-Yr Rainfall=3.10"

Printed 4/6/2021

Page 13

## Summary for Pond A: POI-A

Inflow Area = 289,843 sf, 51.53% Impervious, Inflow Depth = 1.02" for 2-Yr event  
Inflow = 6.62 cfs @ 12.11 hrs, Volume= 24,565 cf  
Primary = 6.62 cfs @ 12.11 hrs, Volume= 24,565 cf, Atten= 0%, Lag= 0.0 min

Routing by Dyn-Stor-Ind method, Time Span= 1.00-36.00 hrs, dt= 0.01 hrs / 2

### Pond A: POI-A

Hydrograph

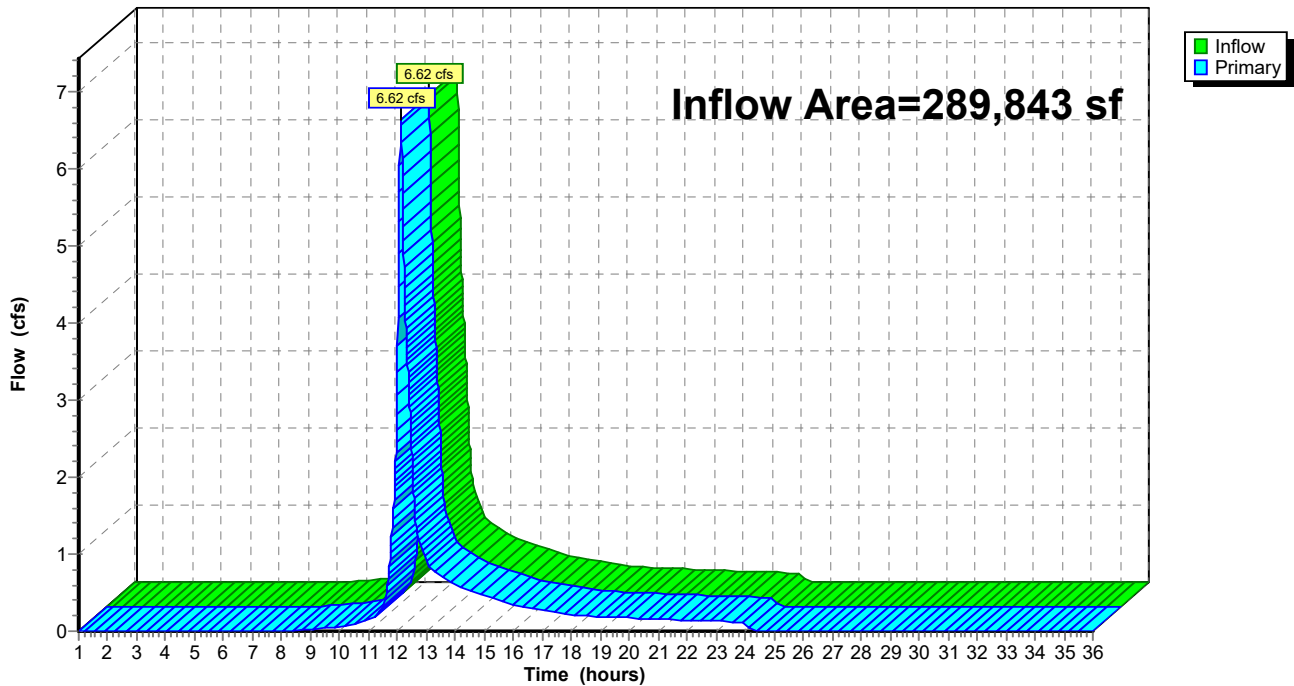

# Cole Pre-Development

Prepared by Weston & Sampson

HydroCAD® 10.00-20 s/n 00455 © 2017 HydroCAD Software Solutions LLC

Type III 24-hr 2-Yr Rainfall=3.10"

Printed 4/6/2021

Page 14

## Summary for Pond B: POI-B

Inflow Area = 12,903 sf, 56.30% Impervious, Inflow Depth = 1.33" for 2-Yr event  
Inflow = 0.45 cfs @ 12.09 hrs, Volume= 1,425 cf  
Primary = 0.45 cfs @ 12.09 hrs, Volume= 1,425 cf, Atten= 0%, Lag= 0.0 min

Routing by Dyn-Stor-Ind method, Time Span= 1.00-36.00 hrs, dt= 0.01 hrs / 2

### Pond B: POI-B

Hydrograph

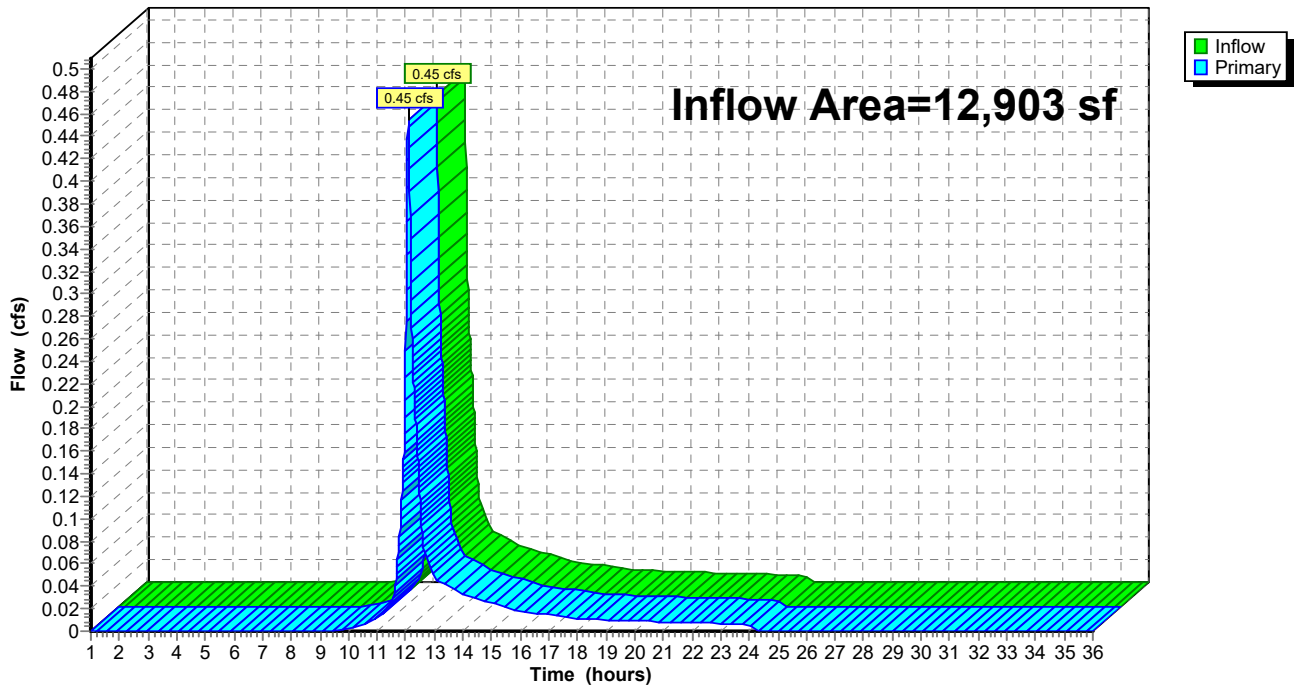

## Cole Pre-Development

Prepared by Weston & Sampson

HydroCAD® 10.00-20 s/n 00455 © 2017 HydroCAD Software Solutions LLC

Type III 24-hr 10-Yr Rainfall=4.70"

Printed 4/6/2021

Page 15

Time span=1.00-36.00 hrs, dt=0.01 hrs, 3501 points x 2  
Runoff by SCS TR-20 method, UH=SCS, Weighted-CN  
Reach routing by Dyn-Stor-Ind method - Pond routing by Dyn-Stor-Ind method

**SubcatchmentA1: SUB-A1** Runoff Area=70,293 sf 66.46% Impervious Runoff Depth=3.19"  
Tc=6.0 min CN=86 Runoff=5.97 cfs 18,675 cf

**SubcatchmentA2: SUB-A2** Runoff Area=30,592 sf 58.29% Impervious Runoff Depth=2.21"  
Tc=6.0 min CN=75 Runoff=1.81 cfs 5,630 cf

**SubcatchmentA3: SUB-A3** Runoff Area=144,484 sf 50.55% Impervious Runoff Depth=1.97"  
Flow Length=152' Tc=9.3 min CN=72 Runoff=6.73 cfs 23,713 cf

**SubcatchmentA4: SUB-A4** Runoff Area=44,474 sf 26.50% Impervious Runoff Depth=1.07"  
Flow Length=463' Tc=12.7 min CN=59 Runoff=0.87 cfs 3,958 cf

**SubcatchmentB1: SUB-B1** Runoff Area=12,903 sf 56.30% Impervious Runoff Depth=2.63"  
Tc=6.0 min CN=80 Runoff=0.91 cfs 2,831 cf

**Pond A: POI-A** Inflow=14.62 cfs 51,976 cf  
Primary=14.62 cfs 51,976 cf

**Pond B: POI-B** Inflow=0.91 cfs 2,831 cf  
Primary=0.91 cfs 2,831 cf

**Total Runoff Area = 302,746 sf Runoff Volume = 54,807 cf Average Runoff Depth = 2.17"**  
**48.26% Pervious = 146,115 sf 51.74% Impervious = 156,631 sf**

**Cole Pre-Development**

Prepared by Weston & Sampson

HydroCAD® 10.00-20 s/n 00455 © 2017 HydroCAD Software Solutions LLC

Type III 24-hr 10-Yr Rainfall=4.70"

Printed 4/6/2021

Page 16

**Summary for Subcatchment A1: SUB-A1**

Runoff = 5.97 cfs @ 12.09 hrs, Volume= 18,675 cf, Depth= 3.19"

Runoff by SCS TR-20 method, UH=SCS, Weighted-CN, Time Span= 1.00-36.00 hrs, dt= 0.01 hrs  
Type III 24-hr 10-Yr Rainfall=4.70"

	Area (sf)	CN	Description
*	25,439	98	Paved Impervious, HSG B
	21,280	98	Roofs, HSG B
	22,661	61	>75% Grass cover, Good, HSG B
	913	55	Woods, Good, HSG B
	70,293	86	Weighted Average
	23,574		33.54% Pervious Area
	46,719		66.46% Impervious Area

Tc (min)	Length (feet)	Slope (ft/ft)	Velocity (ft/sec)	Capacity (cfs)	Description
6.0					Direct Entry,

**Subcatchment A1: SUB-A1**

Hydrograph

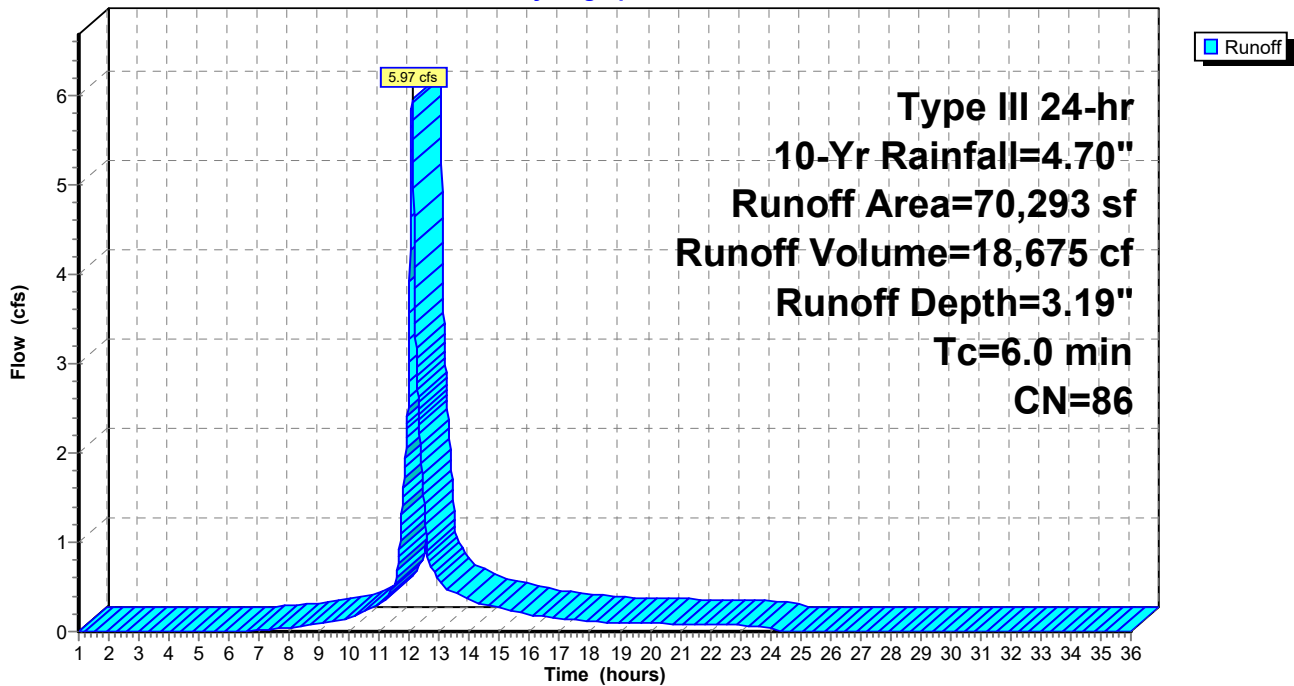

**Cole Pre-Development**

Prepared by Weston & Sampson

HydroCAD® 10.00-20 s/n 00455 © 2017 HydroCAD Software Solutions LLC

Type III 24-hr 10-Yr Rainfall=4.70"

Printed 4/6/2021

Page 17

**Summary for Subcatchment A2: SUB-A2**

Runoff = 1.81 cfs @ 12.09 hrs, Volume= 5,630 cf, Depth= 2.21"

Runoff by SCS TR-20 method, UH=SCS, Weighted-CN, Time Span= 1.00-36.00 hrs, dt= 0.01 hrs  
Type III 24-hr 10-Yr Rainfall=4.70"

	Area (sf)	CN	Description
*	14,124	98	Paved Impervious, HSG A
*	2,639	98	Paved Impervious, HSG B
	1,068	98	Roofs, HSG A
	11,139	39	>75% Grass cover, Good, HSG A
	1,622	61	>75% Grass cover, Good, HSG B
	30,592	75	Weighted Average
	12,761		41.71% Pervious Area
	17,831		58.29% Impervious Area

Tc (min)	Length (feet)	Slope (ft/ft)	Velocity (ft/sec)	Capacity (cfs)	Description
6.0					Direct Entry,

**Subcatchment A2: SUB-A2**

Hydrograph

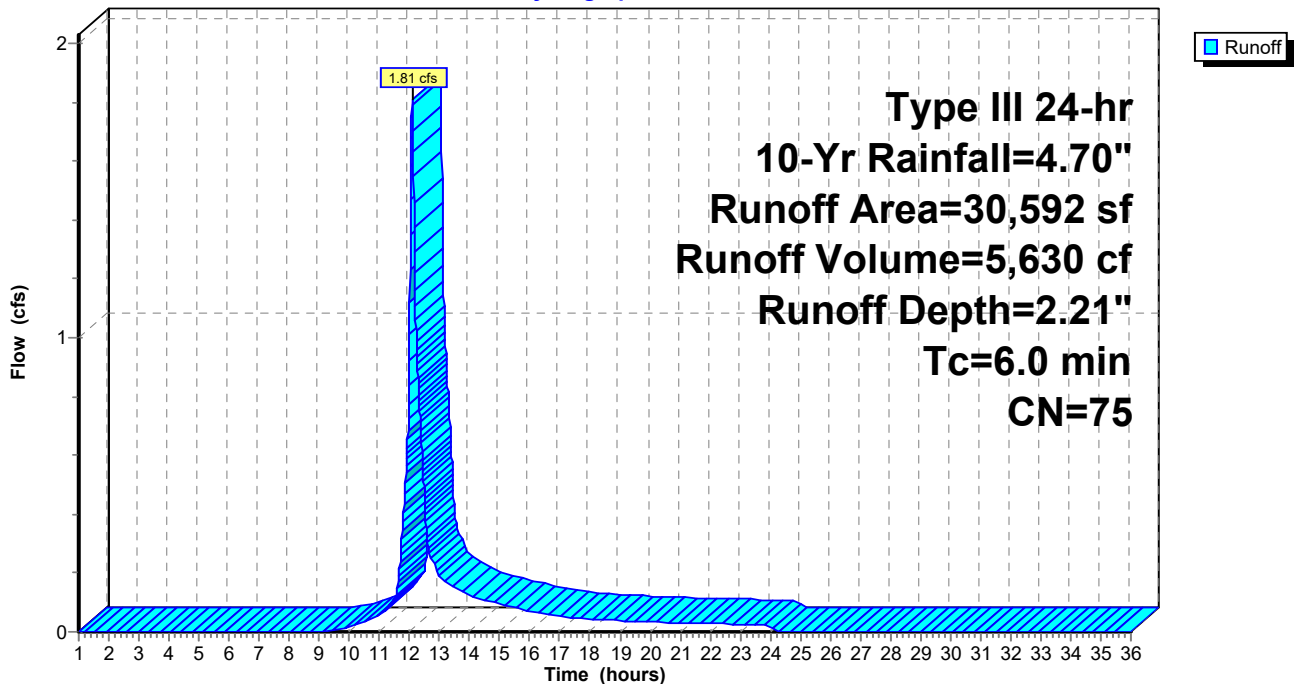

# Cole Pre-Development

Prepared by Weston & Sampson

HydroCAD® 10.00-20 s/n 00455 © 2017 HydroCAD Software Solutions LLC

Type III 24-hr 10-Yr Rainfall=4.70"

Printed 4/6/2021

Page 18

## Summary for Subcatchment A3: SUB-A3

Runoff = 6.73 cfs @ 12.14 hrs, Volume= 23,713 cf, Depth= 1.97"

Runoff by SCS TR-20 method, UH=SCS, Weighted-CN, Time Span= 1.00-36.00 hrs, dt= 0.01 hrs  
Type III 24-hr 10-Yr Rainfall=4.70"

Area (sf)	CN	Description
* 26,940	98	Paved Impervious, HSG A
* 23,438	98	Paved Impervious, HSG B
20,776	39	>75% Grass cover, Good, HSG A
23,581	61	>75% Grass cover, Good, HSG B
19,969	30	Woods, Good, HSG A
7,127	55	Woods, Good, HSG B
5,397	98	Roofs, HSG A
17,256	98	Roofs, HSG B
144,484	72	Weighted Average
71,453		49.45% Pervious Area
73,031		50.55% Impervious Area

Tc (min)	Length (feet)	Slope (ft/ft)	Velocity (ft/sec)	Capacity (cfs)	Description
7.8	50	0.0600	0.11		<b>Sheet Flow,</b> Woods: Light underbrush n= 0.400 P2= 3.30"
0.7	41	0.0340	0.92		<b>Shallow Concentrated Flow,</b> Woodland Kv= 5.0 fps
0.8	61	0.0340	1.29		<b>Shallow Concentrated Flow,</b> Short Grass Pasture Kv= 7.0 fps
9.3	152	Total			



**Subcatchment A3: SUB-A3**

Hydrograph

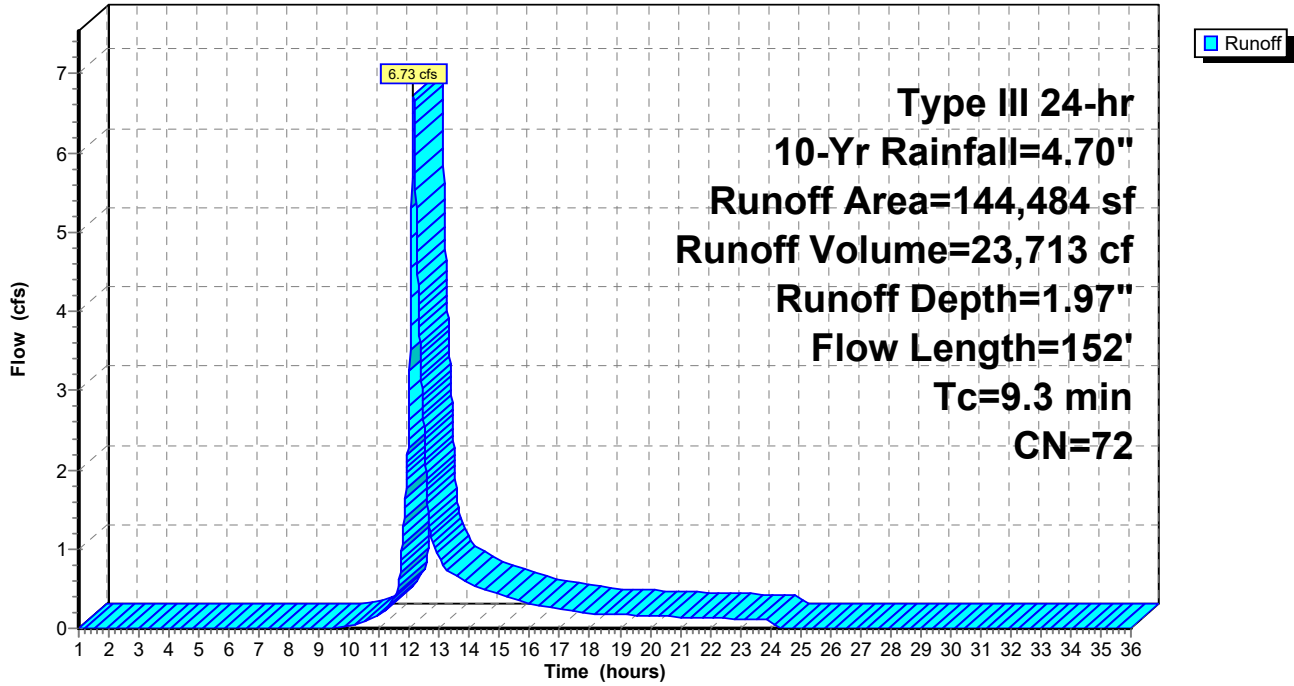

# Cole Pre-Development

Prepared by Weston & Sampson

HydroCAD® 10.00-20 s/n 00455 © 2017 HydroCAD Software Solutions LLC

Type III 24-hr 10-Yr Rainfall=4.70"

Printed 4/6/2021

Page 20

## Summary for Subcatchment A4: SUB-A4

Runoff = 0.87 cfs @ 12.20 hrs, Volume= 3,958 cf, Depth= 1.07"

Runoff by SCS TR-20 method, UH=SCS, Weighted-CN, Time Span= 1.00-36.00 hrs, dt= 0.01 hrs  
Type III 24-hr 10-Yr Rainfall=4.70"

Area (sf)	CN	Description
* 3,654	98	Paved Impervious, HSG A
* 8,132	98	Paved Impervious, HSG B
2,071	39	>75% Grass cover, Good, HSG A
3,960	61	>75% Grass cover, Good, HSG B
13,634	30	Woods, Good, HSG A
13,023	55	Woods, Good, HSG B
44,474	59	Weighted Average
32,688		73.50% Pervious Area
11,786		26.50% Impervious Area

Tc (min)	Length (feet)	Slope (ft/ft)	Velocity (ft/sec)	Capacity (cfs)	Description
7.8	50	0.0600	0.11		<b>Sheet Flow,</b> Woods: Light underbrush n= 0.400 P2= 3.30"
2.5	120	0.0250	0.79		<b>Shallow Concentrated Flow,</b> Woodland Kv= 5.0 fps
2.4	293	0.0100	2.03		<b>Shallow Concentrated Flow,</b> Paved Kv= 20.3 fps
12.7	463	Total			

**Cole Pre-Development**

Prepared by Weston & Sampson

HydroCAD® 10.00-20 s/n 00455 © 2017 HydroCAD Software Solutions LLC

Type III 24-hr 10-Yr Rainfall=4.70"

Printed 4/6/2021

Page 21

**Subcatchment A4: SUB-A4**

Hydrograph

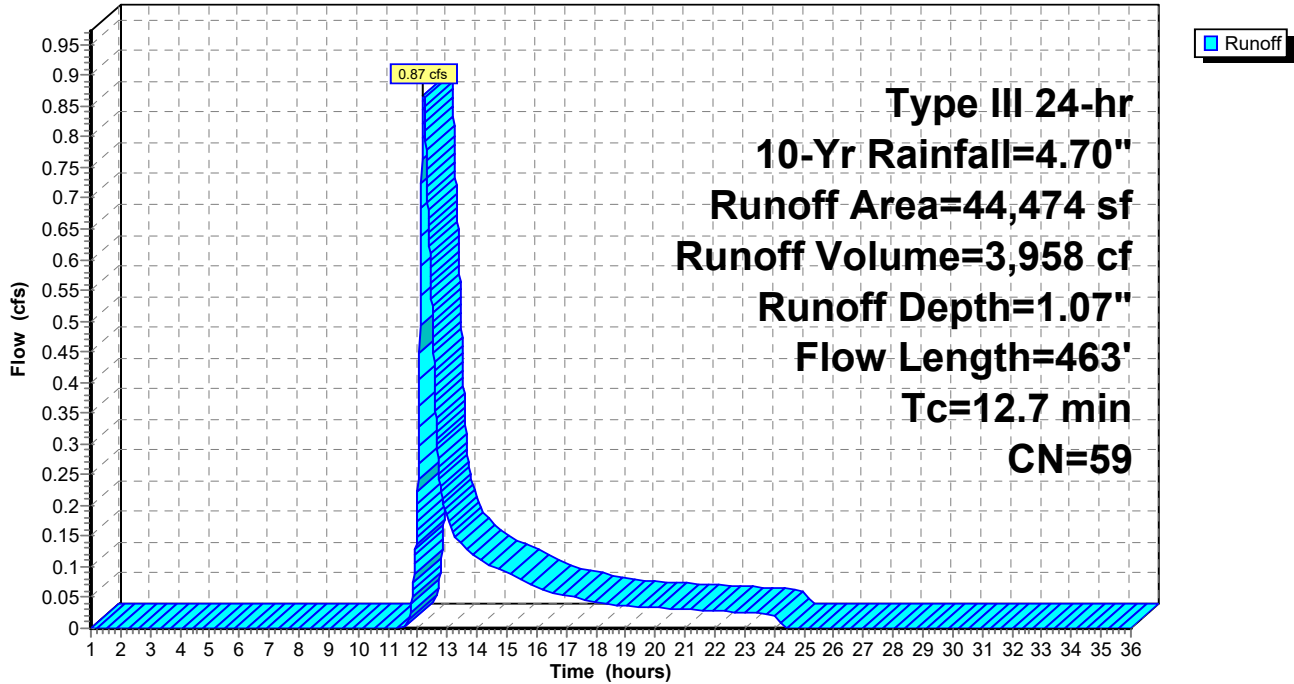

**Cole Pre-Development**

Prepared by Weston & Sampson

HydroCAD® 10.00-20 s/n 00455 © 2017 HydroCAD Software Solutions LLC

Type III 24-hr 10-Yr Rainfall=4.70"

Printed 4/6/2021

Page 22

**Summary for Subcatchment B1: SUB-B1**

Runoff = 0.91 cfs @ 12.09 hrs, Volume= 2,831 cf, Depth= 2.63"

Runoff by SCS TR-20 method, UH=SCS, Weighted-CN, Time Span= 1.00-36.00 hrs, dt= 0.01 hrs  
Type III 24-hr 10-Yr Rainfall=4.70"

	Area (sf)	CN	Description
*	6,295	98	Paved Impervious, HSG B
	969	98	Roofs, HSG A
	638	39	>75% Grass cover, Good, HSG A
	4,212	61	>75% Grass cover, Good, HSG B
	789	55	Woods, Good, HSG B
	12,903	80	Weighted Average
	5,639		43.70% Pervious Area
	7,264		56.30% Impervious Area

Tc (min)	Length (feet)	Slope (ft/ft)	Velocity (ft/sec)	Capacity (cfs)	Description
6.0					Direct Entry,

**Subcatchment B1: SUB-B1**

Hydrograph

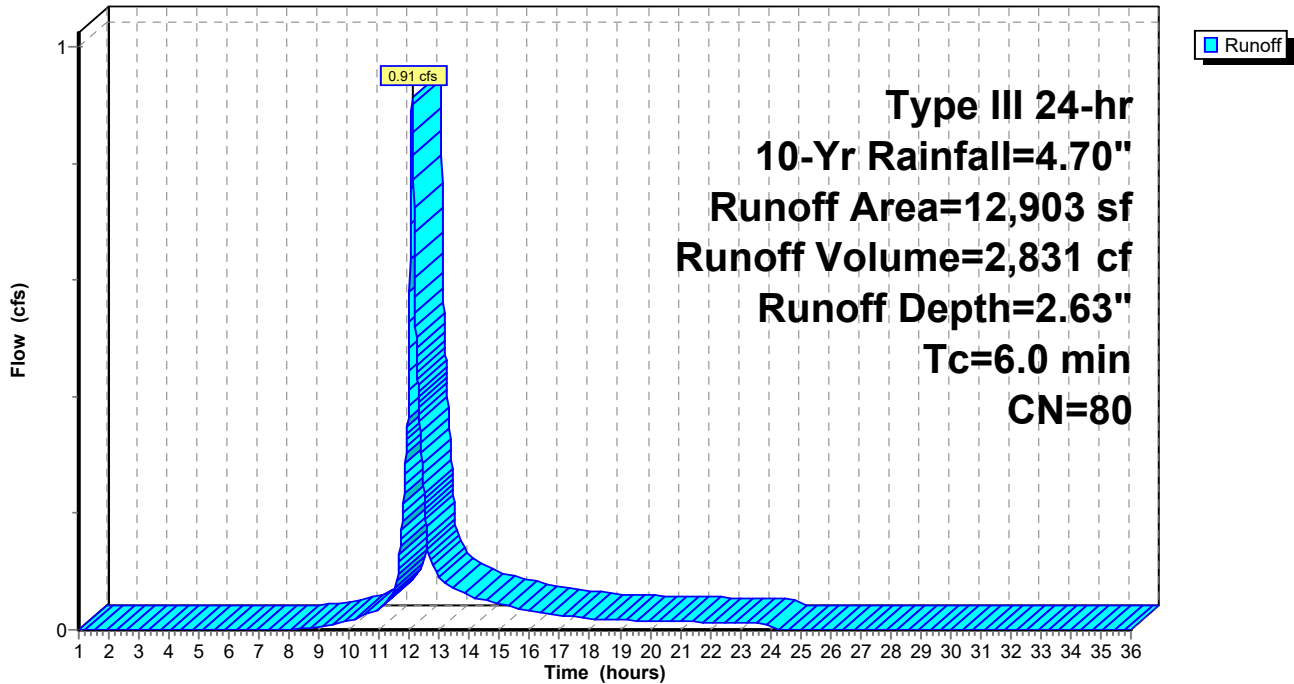

# Cole Pre-Development

Prepared by Weston & Sampson

HydroCAD® 10.00-20 s/n 00455 © 2017 HydroCAD Software Solutions LLC

Type III 24-hr 10-Yr Rainfall=4.70"

Printed 4/6/2021

Page 23

## Summary for Pond A: POI-A

Inflow Area = 289,843 sf, 51.53% Impervious, Inflow Depth = 2.15" for 10-Yr event  
Inflow = 14.62 cfs @ 12.11 hrs, Volume= 51,976 cf  
Primary = 14.62 cfs @ 12.11 hrs, Volume= 51,976 cf, Atten= 0%, Lag= 0.0 min

Routing by Dyn-Stor-Ind method, Time Span= 1.00-36.00 hrs, dt= 0.01 hrs / 2

### Pond A: POI-A

Hydrograph

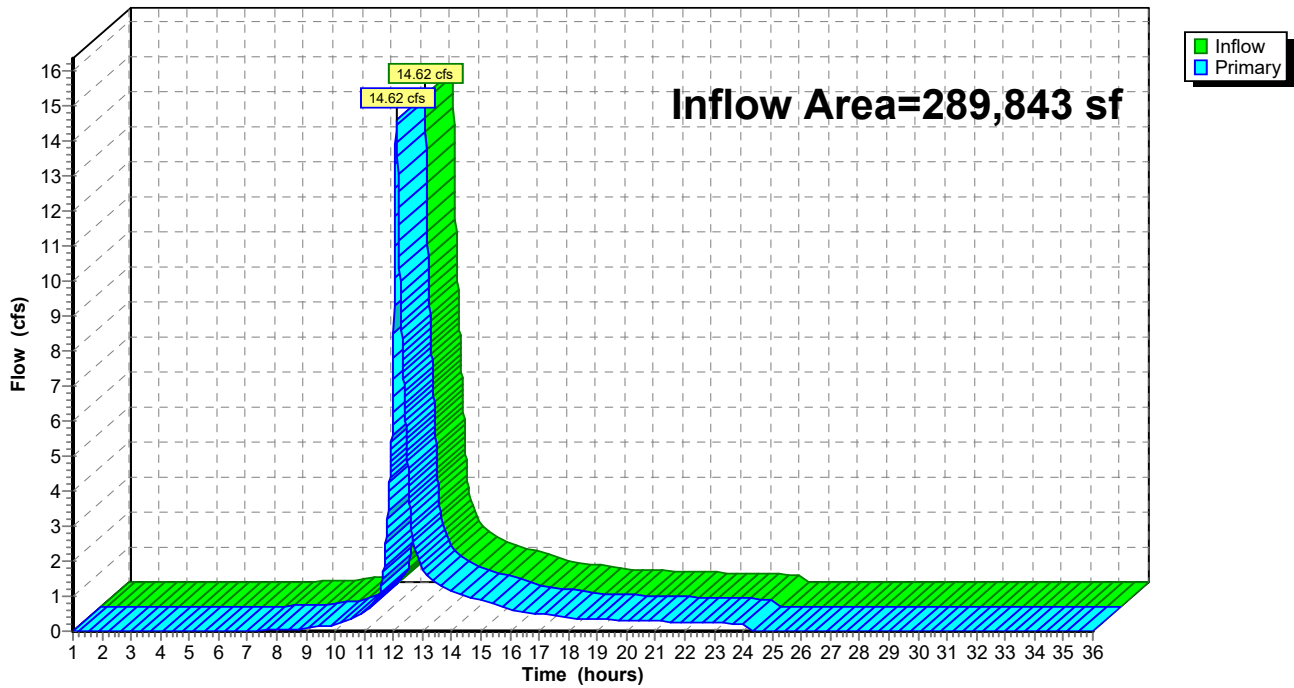

**Cole Pre-Development**

Prepared by Weston & Sampson

HydroCAD® 10.00-20 s/n 00455 © 2017 HydroCAD Software Solutions LLC

Type III 24-hr 10-Yr Rainfall=4.70"

Printed 4/6/2021

Page 24

**Summary for Pond B: POI-B**

Inflow Area = 12,903 sf, 56.30% Impervious, Inflow Depth = 2.63" for 10-Yr event  
Inflow = 0.91 cfs @ 12.09 hrs, Volume= 2,831 cf  
Primary = 0.91 cfs @ 12.09 hrs, Volume= 2,831 cf, Atten= 0%, Lag= 0.0 min

Routing by Dyn-Stor-Ind method, Time Span= 1.00-36.00 hrs, dt= 0.01 hrs / 2

**Pond B: POI-B**

Hydrograph

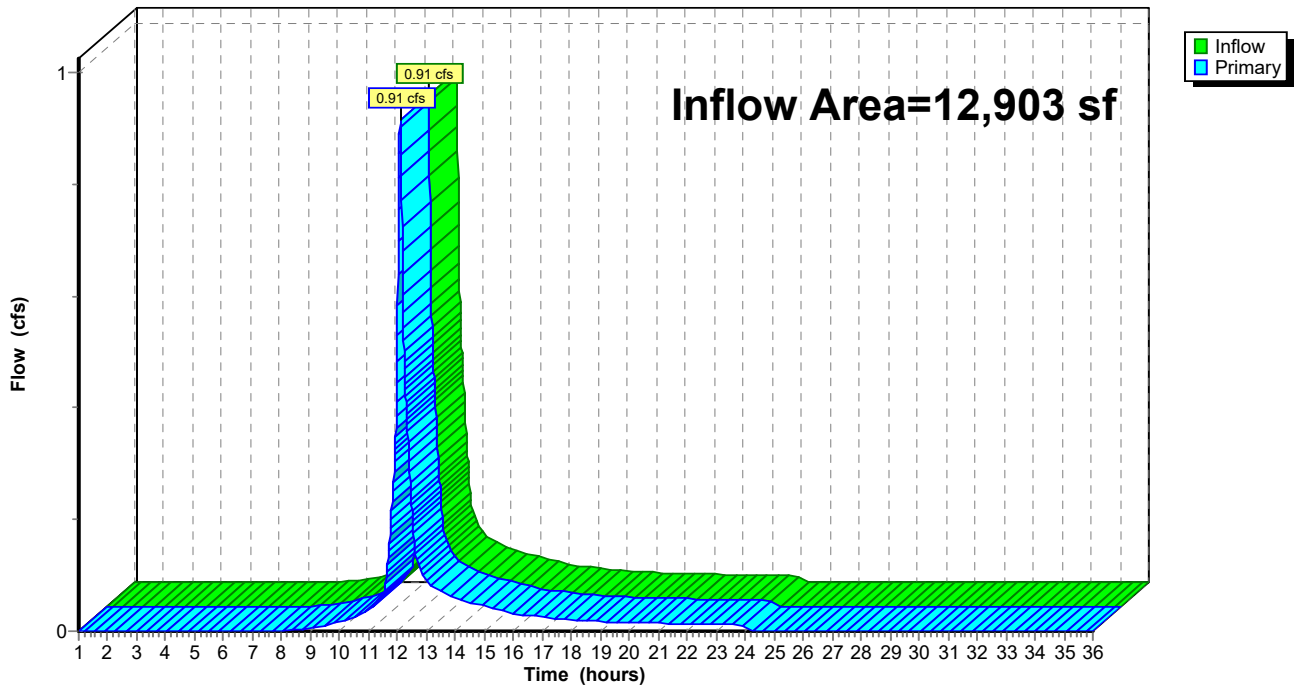

## Cole Pre-Development

Prepared by Weston & Sampson

HydroCAD® 10.00-20 s/n 00455 © 2017 HydroCAD Software Solutions LLC

Type III 24-hr 25-Yr Rainfall=5.80"

Printed 4/6/2021

Page 25

Time span=1.00-36.00 hrs, dt=0.01 hrs, 3501 points x 2  
Runoff by SCS TR-20 method, UH=SCS, Weighted-CN  
Reach routing by Dyn-Stor-Ind method - Pond routing by Dyn-Stor-Ind method

**SubcatchmentA1: SUB-A1** Runoff Area=70,293 sf 66.46% Impervious Runoff Depth=4.22"  
Tc=6.0 min CN=86 Runoff=7.81 cfs 24,718 cf

**SubcatchmentA2: SUB-A2** Runoff Area=30,592 sf 58.29% Impervious Runoff Depth=3.11"  
Tc=6.0 min CN=75 Runoff=2.56 cfs 7,934 cf

**SubcatchmentA3: SUB-A3** Runoff Area=144,484 sf 50.55% Impervious Runoff Depth=2.83"  
Flow Length=152' Tc=9.3 min CN=72 Runoff=9.79 cfs 34,080 cf

**SubcatchmentA4: SUB-A4** Runoff Area=44,474 sf 26.50% Impervious Runoff Depth=1.71"  
Flow Length=463' Tc=12.7 min CN=59 Runoff=1.52 cfs 6,346 cf

**SubcatchmentB1: SUB-B1** Runoff Area=12,903 sf 56.30% Impervious Runoff Depth=3.60"  
Tc=6.0 min CN=80 Runoff=1.25 cfs 3,872 cf

**Pond A: POI-A** Inflow=20.67 cfs 73,078 cf  
Primary=20.67 cfs 73,078 cf

**Pond B: POI-B** Inflow=1.25 cfs 3,872 cf  
Primary=1.25 cfs 3,872 cf

**Total Runoff Area = 302,746 sf Runoff Volume = 76,950 cf Average Runoff Depth = 3.05"**  
**48.26% Pervious = 146,115 sf 51.74% Impervious = 156,631 sf**

**Cole Pre-Development**

Prepared by Weston & Sampson

HydroCAD® 10.00-20 s/n 00455 © 2017 HydroCAD Software Solutions LLC

Type III 24-hr 25-Yr Rainfall=5.80"

Printed 4/6/2021

Page 26

**Summary for Subcatchment A1: SUB-A1**

Runoff = 7.81 cfs @ 12.09 hrs, Volume= 24,718 cf, Depth= 4.22"

Runoff by SCS TR-20 method, UH=SCS, Weighted-CN, Time Span= 1.00-36.00 hrs, dt= 0.01 hrs  
Type III 24-hr 25-Yr Rainfall=5.80"

	Area (sf)	CN	Description
*	25,439	98	Paved Impervious, HSG B
	21,280	98	Roofs, HSG B
	22,661	61	>75% Grass cover, Good, HSG B
	913	55	Woods, Good, HSG B
	70,293	86	Weighted Average
	23,574		33.54% Pervious Area
	46,719		66.46% Impervious Area

Tc (min)	Length (feet)	Slope (ft/ft)	Velocity (ft/sec)	Capacity (cfs)	Description
6.0					Direct Entry,

**Subcatchment A1: SUB-A1**

Hydrograph

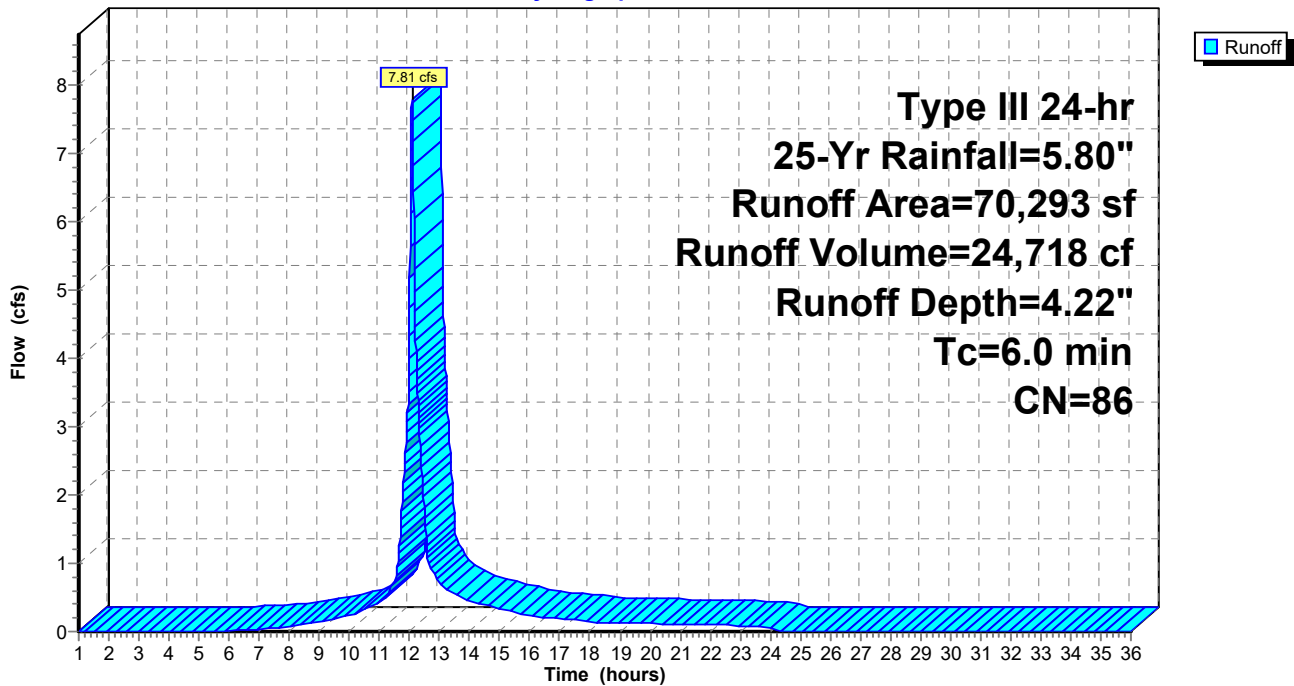



**Cole Pre-Development**

Prepared by Weston & Sampson

HydroCAD® 10.00-20 s/n 00455 © 2017 HydroCAD Software Solutions LLC

Type III 24-hr 25-Yr Rainfall=5.80"

Printed 4/6/2021

Page 27

**Summary for Subcatchment A2: SUB-A2**

Runoff = 2.56 cfs @ 12.09 hrs, Volume= 7,934 cf, Depth= 3.11"

Runoff by SCS TR-20 method, UH=SCS, Weighted-CN, Time Span= 1.00-36.00 hrs, dt= 0.01 hrs  
Type III 24-hr 25-Yr Rainfall=5.80"

	Area (sf)	CN	Description
*	14,124	98	Paved Impervious, HSG A
*	2,639	98	Paved Impervious, HSG B
	1,068	98	Roofs, HSG A
	11,139	39	>75% Grass cover, Good, HSG A
	1,622	61	>75% Grass cover, Good, HSG B
	30,592	75	Weighted Average
	12,761		41.71% Pervious Area
	17,831		58.29% Impervious Area

Tc (min)	Length (feet)	Slope (ft/ft)	Velocity (ft/sec)	Capacity (cfs)	Description
6.0					Direct Entry,

**Subcatchment A2: SUB-A2**

Hydrograph

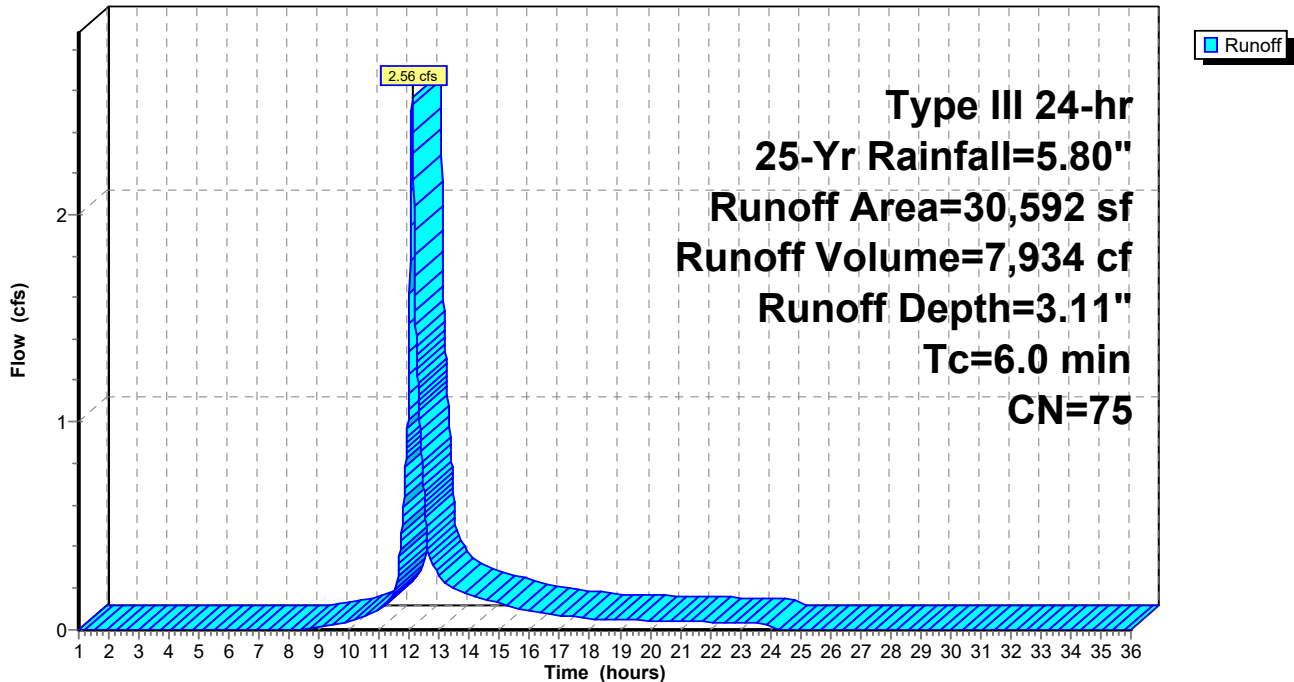

# Cole Pre-Development

Prepared by Weston & Sampson

HydroCAD® 10.00-20 s/n 00455 © 2017 HydroCAD Software Solutions LLC

Type III 24-hr 25-Yr Rainfall=5.80"

Printed 4/6/2021

Page 28

## Summary for Subcatchment A3: SUB-A3

Runoff = 9.79 cfs @ 12.13 hrs, Volume= 34,080 cf, Depth= 2.83"

Runoff by SCS TR-20 method, UH=SCS, Weighted-CN, Time Span= 1.00-36.00 hrs, dt= 0.01 hrs  
Type III 24-hr 25-Yr Rainfall=5.80"

Area (sf)	CN	Description
* 26,940	98	Paved Impervious, HSG A
* 23,438	98	Paved Impervious, HSG B
20,776	39	>75% Grass cover, Good, HSG A
23,581	61	>75% Grass cover, Good, HSG B
19,969	30	Woods, Good, HSG A
7,127	55	Woods, Good, HSG B
5,397	98	Roofs, HSG A
17,256	98	Roofs, HSG B
144,484	72	Weighted Average
71,453		49.45% Pervious Area
73,031		50.55% Impervious Area

Tc (min)	Length (feet)	Slope (ft/ft)	Velocity (ft/sec)	Capacity (cfs)	Description
7.8	50	0.0600	0.11		<b>Sheet Flow,</b> Woods: Light underbrush n= 0.400 P2= 3.30"
0.7	41	0.0340	0.92		<b>Shallow Concentrated Flow,</b> Woodland Kv= 5.0 fps
0.8	61	0.0340	1.29		<b>Shallow Concentrated Flow,</b> Short Grass Pasture Kv= 7.0 fps
9.3	152	Total			

**Subcatchment A3: SUB-A3**

Hydrograph

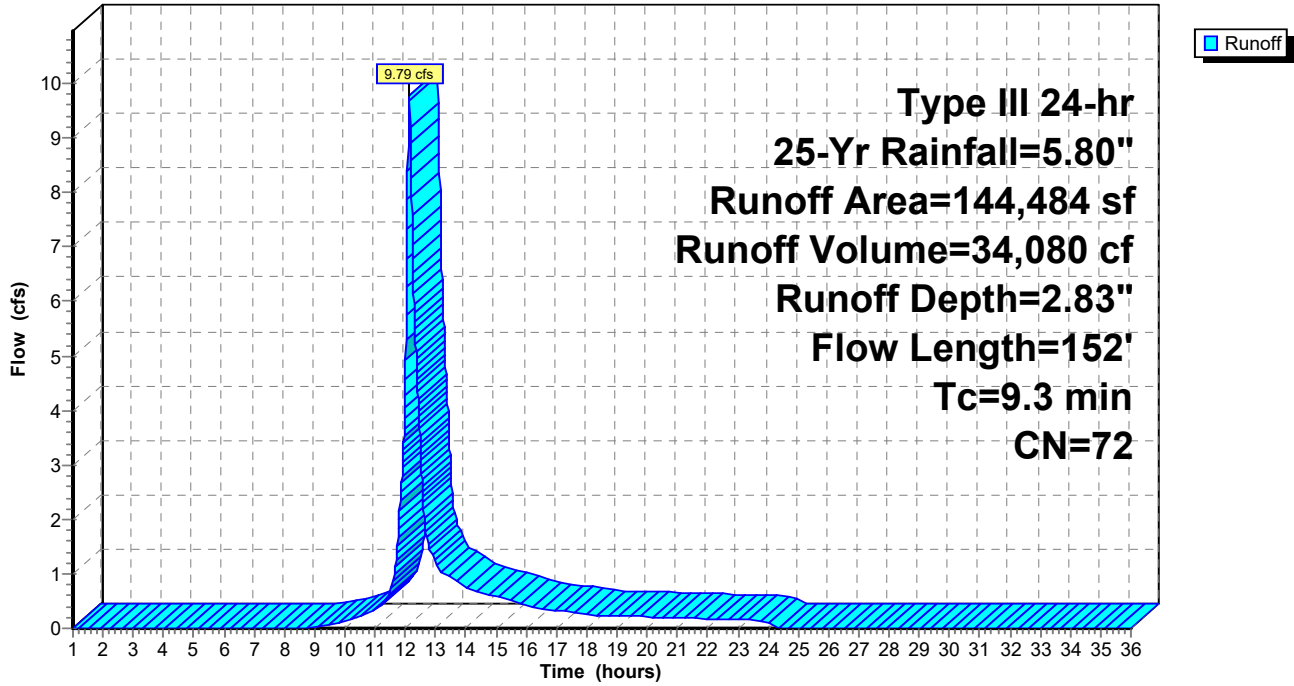

**Cole Pre-Development**

Prepared by Weston & Sampson

HydroCAD® 10.00-20 s/n 00455 © 2017 HydroCAD Software Solutions LLC

Type III 24-hr 25-Yr Rainfall=5.80"

Printed 4/6/2021

Page 30

**Summary for Subcatchment A4: SUB-A4**

Runoff = 1.52 cfs @ 12.19 hrs, Volume= 6,346 cf, Depth= 1.71"

Runoff by SCS TR-20 method, UH=SCS, Weighted-CN, Time Span= 1.00-36.00 hrs, dt= 0.01 hrs  
Type III 24-hr 25-Yr Rainfall=5.80"

Area (sf)	CN	Description
* 3,654	98	Paved Impervious, HSG A
* 8,132	98	Paved Impervious, HSG B
2,071	39	>75% Grass cover, Good, HSG A
3,960	61	>75% Grass cover, Good, HSG B
13,634	30	Woods, Good, HSG A
13,023	55	Woods, Good, HSG B
44,474	59	Weighted Average
32,688		73.50% Pervious Area
11,786		26.50% Impervious Area

Tc (min)	Length (feet)	Slope (ft/ft)	Velocity (ft/sec)	Capacity (cfs)	Description
7.8	50	0.0600	0.11		<b>Sheet Flow,</b> Woods: Light underbrush n= 0.400 P2= 3.30"
2.5	120	0.0250	0.79		<b>Shallow Concentrated Flow,</b> Woodland Kv= 5.0 fps
2.4	293	0.0100	2.03		<b>Shallow Concentrated Flow,</b> Paved Kv= 20.3 fps
12.7	463	Total			

**Subcatchment A4: SUB-A4**

Hydrograph

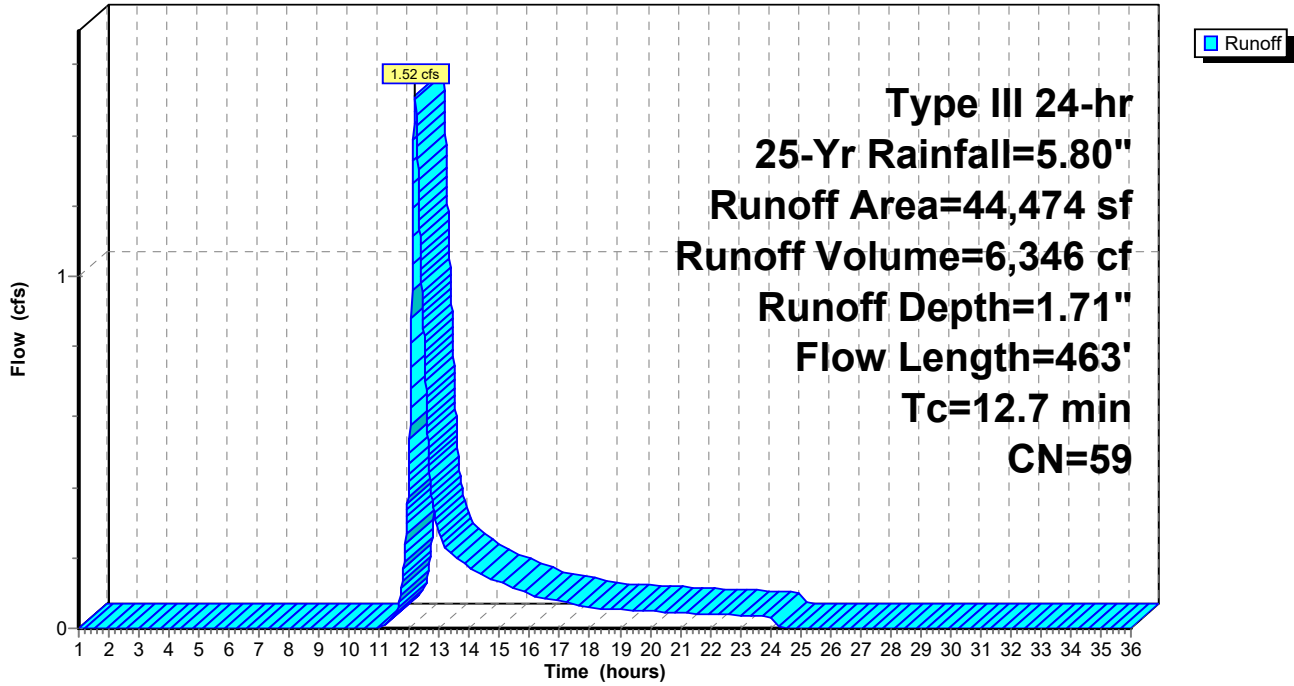

# Cole Pre-Development

Prepared by Weston & Sampson

HydroCAD® 10.00-20 s/n 00455 © 2017 HydroCAD Software Solutions LLC

Type III 24-hr 25-Yr Rainfall=5.80"

Printed 4/6/2021

Page 32

## Summary for Subcatchment B1: SUB-B1

Runoff = 1.25 cfs @ 12.09 hrs, Volume= 3,872 cf, Depth= 3.60"

Runoff by SCS TR-20 method, UH=SCS, Weighted-CN, Time Span= 1.00-36.00 hrs, dt= 0.01 hrs  
Type III 24-hr 25-Yr Rainfall=5.80"

	Area (sf)	CN	Description
*	6,295	98	Paved Impervious, HSG B
	969	98	Roofs, HSG A
	638	39	>75% Grass cover, Good, HSG A
	4,212	61	>75% Grass cover, Good, HSG B
	789	55	Woods, Good, HSG B
<hr/>			
	12,903	80	Weighted Average
	5,639		43.70% Pervious Area
	7,264		56.30% Impervious Area

Tc (min)	Length (feet)	Slope (ft/ft)	Velocity (ft/sec)	Capacity (cfs)	Description
6.0					Direct Entry,

## Subcatchment B1: SUB-B1

Hydrograph

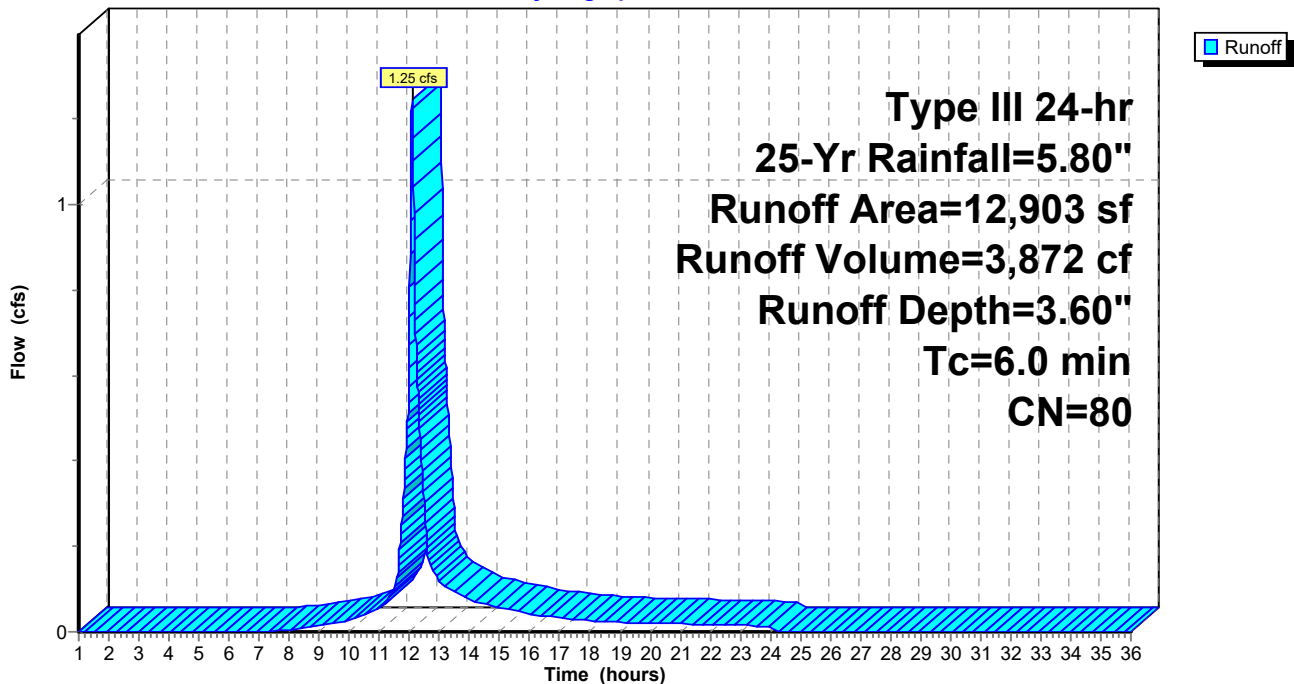

# Cole Pre-Development

Prepared by Weston & Sampson

HydroCAD® 10.00-20 s/n 00455 © 2017 HydroCAD Software Solutions LLC

Type III 24-hr 25-Yr Rainfall=5.80"

Printed 4/6/2021

Page 33

## Summary for Pond A: POI-A

Inflow Area = 289,843 sf, 51.53% Impervious, Inflow Depth = 3.03" for 25-Yr event  
Inflow = 20.67 cfs @ 12.11 hrs, Volume= 73,078 cf  
Primary = 20.67 cfs @ 12.11 hrs, Volume= 73,078 cf, Atten= 0%, Lag= 0.0 min

Routing by Dyn-Stor-Ind method, Time Span= 1.00-36.00 hrs, dt= 0.01 hrs / 2

### Pond A: POI-A

Hydrograph

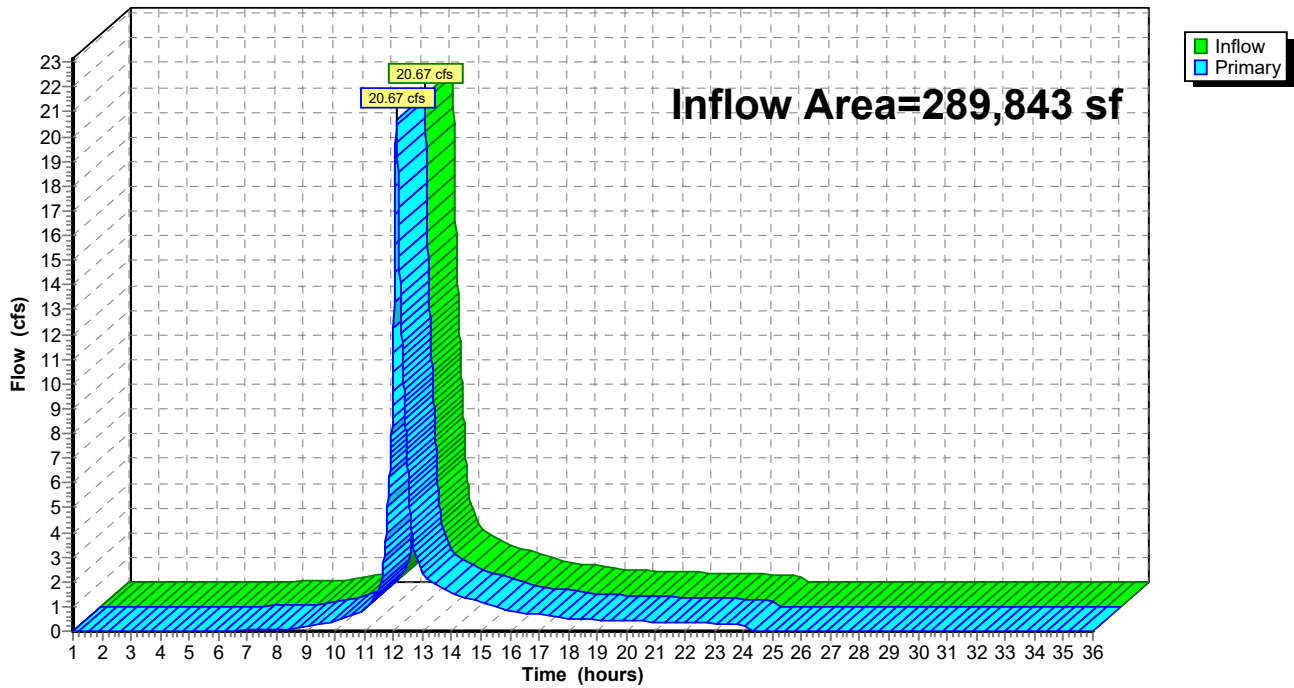

**Cole Pre-Development**

Prepared by Weston & Sampson

HydroCAD® 10.00-20 s/n 00455 © 2017 HydroCAD Software Solutions LLC

Type III 24-hr 25-Yr Rainfall=5.80"

Printed 4/6/2021

Page 34

**Summary for Pond B: POI-B**

Inflow Area = 12,903 sf, 56.30% Impervious, Inflow Depth = 3.60" for 25-Yr event  
Inflow = 1.25 cfs @ 12.09 hrs, Volume= 3,872 cf  
Primary = 1.25 cfs @ 12.09 hrs, Volume= 3,872 cf, Atten= 0%, Lag= 0.0 min

Routing by Dyn-Stor-Ind method, Time Span= 1.00-36.00 hrs, dt= 0.01 hrs / 2

**Pond B: POI-B**

Hydrograph

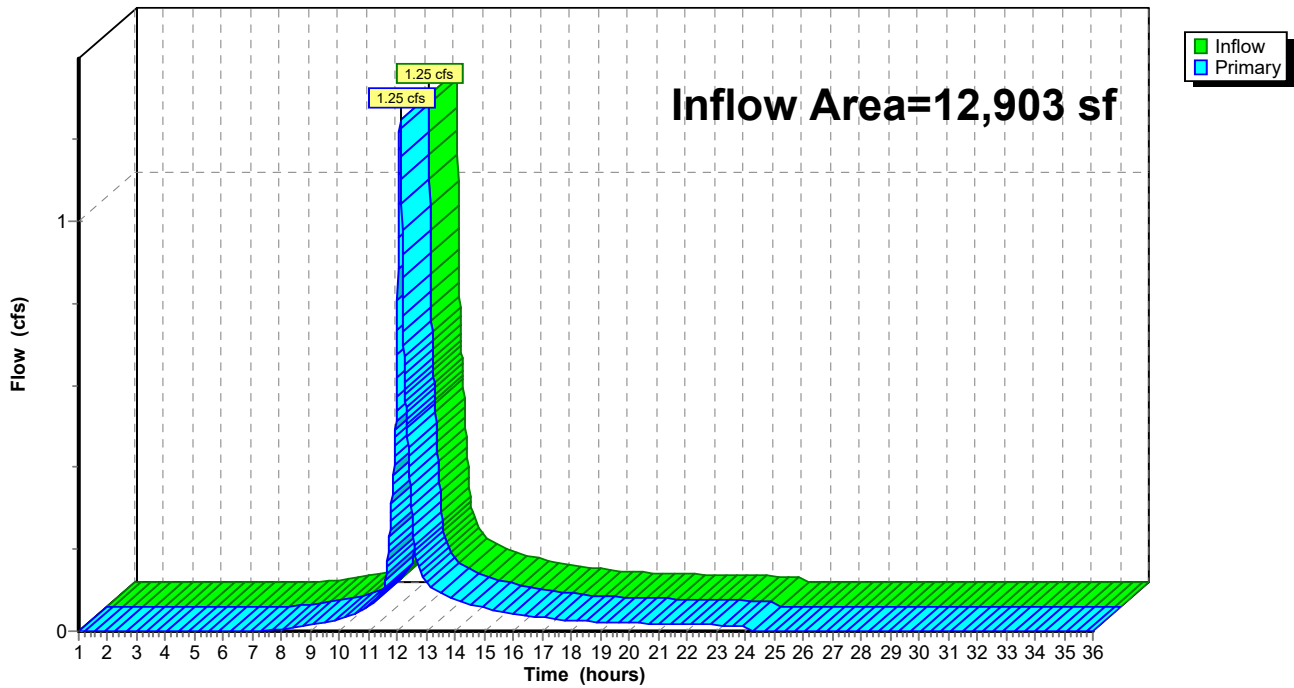



## Cole Pre-Development

Prepared by Weston & Sampson

HydroCAD® 10.00-20 s/n 00455 © 2017 HydroCAD Software Solutions LLC

Type III 24-hr 50-Yr Rainfall=7.10"

Printed 4/6/2021

Page 35

Time span=1.00-36.00 hrs, dt=0.01 hrs, 3501 points x 2  
Runoff by SCS TR-20 method, UH=SCS, Weighted-CN  
Reach routing by Dyn-Stor-Ind method - Pond routing by Dyn-Stor-Ind method

**SubcatchmentA1: SUB-A1** Runoff Area=70,293 sf 66.46% Impervious Runoff Depth=5.46"  
Tc=6.0 min CN=86 Runoff=9.99 cfs 31,995 cf

**SubcatchmentA2: SUB-A2** Runoff Area=30,592 sf 58.29% Impervious Runoff Depth=4.24"  
Tc=6.0 min CN=75 Runoff=3.49 cfs 10,803 cf

**SubcatchmentA3: SUB-A3** Runoff Area=144,484 sf 50.55% Impervious Runoff Depth=3.91"  
Flow Length=152' Tc=9.3 min CN=72 Runoff=13.60 cfs 47,131 cf

**SubcatchmentA4: SUB-A4** Runoff Area=44,474 sf 26.50% Impervious Runoff Depth=2.58"  
Flow Length=463' Tc=12.7 min CN=59 Runoff=2.39 cfs 9,546 cf

**SubcatchmentB1: SUB-B1** Runoff Area=12,903 sf 56.30% Impervious Runoff Depth=4.79"  
Tc=6.0 min CN=80 Runoff=1.65 cfs 5,147 cf

**Pond A: POI-A** Inflow=28.12 cfs 99,474 cf  
Primary=28.12 cfs 99,474 cf

**Pond B: POI-B** Inflow=1.65 cfs 5,147 cf  
Primary=1.65 cfs 5,147 cf

**Total Runoff Area = 302,746 sf Runoff Volume = 104,621 cf Average Runoff Depth = 4.15"**  
**48.26% Pervious = 146,115 sf 51.74% Impervious = 156,631 sf**

**Cole Pre-Development**

Prepared by Weston & Sampson

HydroCAD® 10.00-20 s/n 00455 © 2017 HydroCAD Software Solutions LLC

Type III 24-hr 50-Yr Rainfall=7.10"

Printed 4/6/2021

Page 36

**Summary for Subcatchment A1: SUB-A1**

Runoff = 9.99 cfs @ 12.09 hrs, Volume= 31,995 cf, Depth= 5.46"

Runoff by SCS TR-20 method, UH=SCS, Weighted-CN, Time Span= 1.00-36.00 hrs, dt= 0.01 hrs  
Type III 24-hr 50-Yr Rainfall=7.10"

	Area (sf)	CN	Description
*	25,439	98	Paved Impervious, HSG B
	21,280	98	Roofs, HSG B
	22,661	61	>75% Grass cover, Good, HSG B
	913	55	Woods, Good, HSG B
	70,293	86	Weighted Average
	23,574		33.54% Pervious Area
	46,719		66.46% Impervious Area

Tc (min)	Length (feet)	Slope (ft/ft)	Velocity (ft/sec)	Capacity (cfs)	Description
6.0					Direct Entry,

**Subcatchment A1: SUB-A1**

Hydrograph

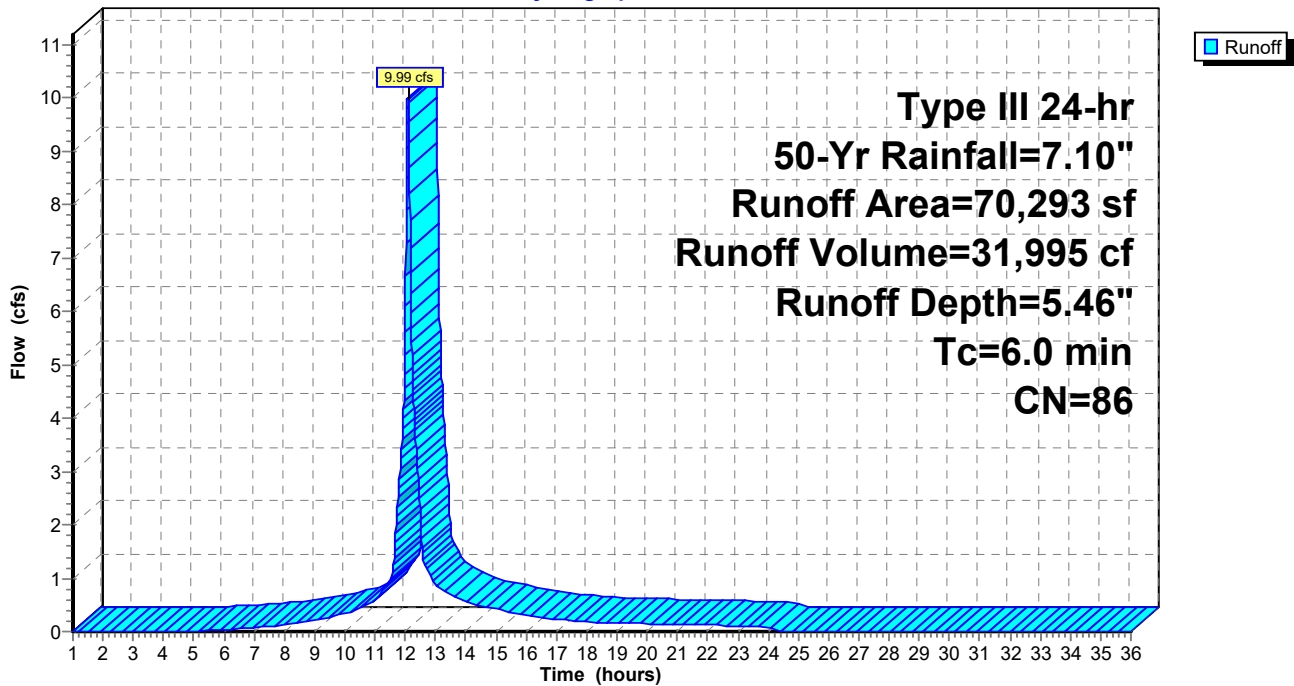

**Cole Pre-Development**

Prepared by Weston & Sampson

HydroCAD® 10.00-20 s/n 00455 © 2017 HydroCAD Software Solutions LLC

Type III 24-hr 50-Yr Rainfall=7.10"

Printed 4/6/2021

Page 37

**Summary for Subcatchment A2: SUB-A2**

Runoff = 3.49 cfs @ 12.09 hrs, Volume= 10,803 cf, Depth= 4.24"

Runoff by SCS TR-20 method, UH=SCS, Weighted-CN, Time Span= 1.00-36.00 hrs, dt= 0.01 hrs  
Type III 24-hr 50-Yr Rainfall=7.10"

	Area (sf)	CN	Description
*	14,124	98	Paved Impervious, HSG A
*	2,639	98	Paved Impervious, HSG B
	1,068	98	Roofs, HSG A
	11,139	39	>75% Grass cover, Good, HSG A
	1,622	61	>75% Grass cover, Good, HSG B
	30,592	75	Weighted Average
	12,761		41.71% Pervious Area
	17,831		58.29% Impervious Area

Tc (min)	Length (feet)	Slope (ft/ft)	Velocity (ft/sec)	Capacity (cfs)	Description
6.0					Direct Entry,

**Subcatchment A2: SUB-A2**

Hydrograph

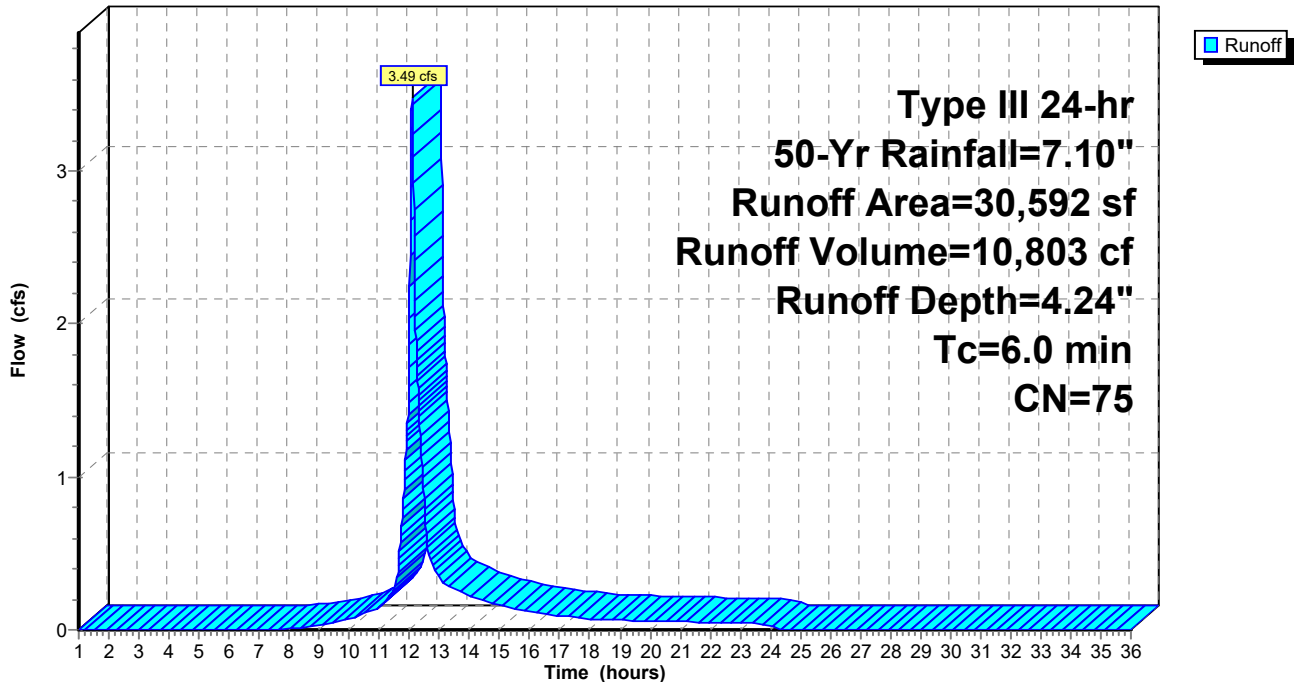

# Cole Pre-Development

Prepared by Weston & Sampson

HydroCAD® 10.00-20 s/n 00455 © 2017 HydroCAD Software Solutions LLC

Type III 24-hr 50-Yr Rainfall=7.10"

Printed 4/6/2021

Page 38

## Summary for Subcatchment A3: SUB-A3

Runoff = 13.60 cfs @ 12.13 hrs, Volume= 47,131 cf, Depth= 3.91"

Runoff by SCS TR-20 method, UH=SCS, Weighted-CN, Time Span= 1.00-36.00 hrs, dt= 0.01 hrs  
Type III 24-hr 50-Yr Rainfall=7.10"

Area (sf)	CN	Description
* 26,940	98	Paved Impervious, HSG A
* 23,438	98	Paved Impervious, HSG B
20,776	39	>75% Grass cover, Good, HSG A
23,581	61	>75% Grass cover, Good, HSG B
19,969	30	Woods, Good, HSG A
7,127	55	Woods, Good, HSG B
5,397	98	Roofs, HSG A
17,256	98	Roofs, HSG B
144,484	72	Weighted Average
71,453		49.45% Pervious Area
73,031		50.55% Impervious Area

Tc (min)	Length (feet)	Slope (ft/ft)	Velocity (ft/sec)	Capacity (cfs)	Description
7.8	50	0.0600	0.11		<b>Sheet Flow,</b> Woods: Light underbrush n= 0.400 P2= 3.30"
0.7	41	0.0340	0.92		<b>Shallow Concentrated Flow,</b> Woodland Kv= 5.0 fps
0.8	61	0.0340	1.29		<b>Shallow Concentrated Flow,</b> Short Grass Pasture Kv= 7.0 fps
9.3	152	Total			

**Subcatchment A3: SUB-A3**

Hydrograph

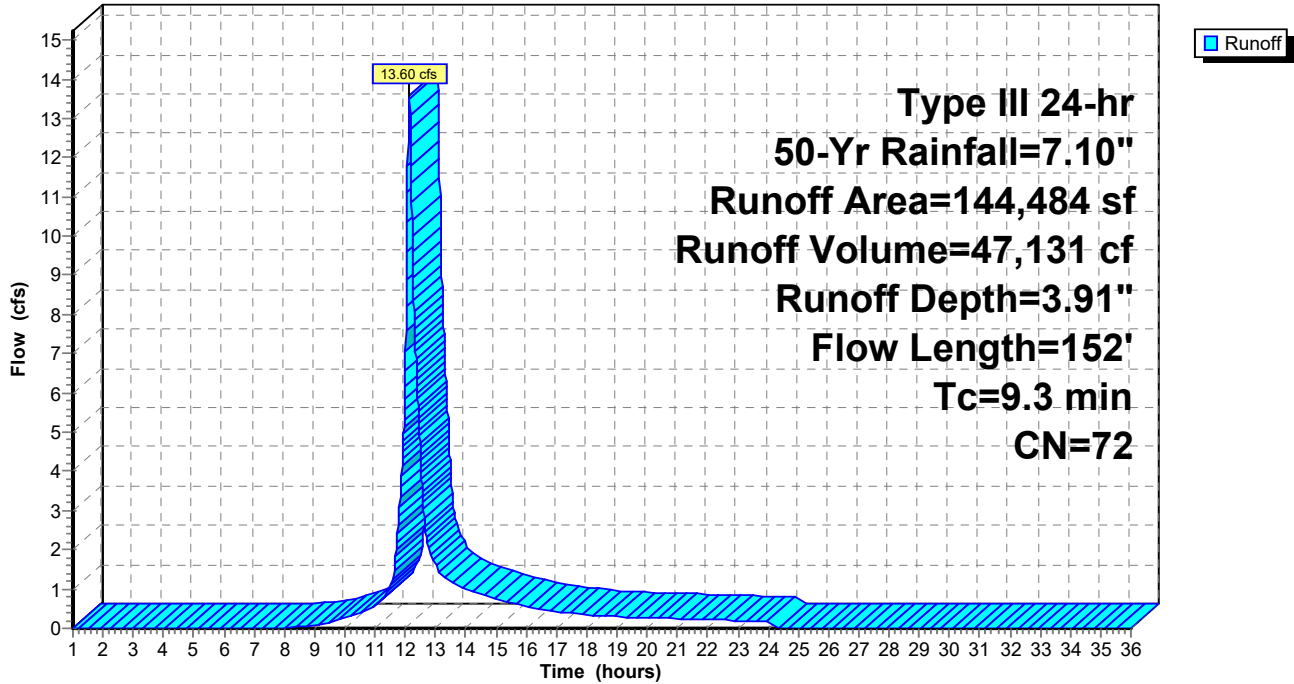

# Cole Pre-Development

Prepared by Weston & Sampson

HydroCAD® 10.00-20 s/n 00455 © 2017 HydroCAD Software Solutions LLC

Type III 24-hr 50-Yr Rainfall=7.10"

Printed 4/6/2021

Page 40

## Summary for Subcatchment A4: SUB-A4

Runoff = 2.39 cfs @ 12.18 hrs, Volume= 9,546 cf, Depth= 2.58"

Runoff by SCS TR-20 method, UH=SCS, Weighted-CN, Time Span= 1.00-36.00 hrs, dt= 0.01 hrs  
Type III 24-hr 50-Yr Rainfall=7.10"

Area (sf)	CN	Description
* 3,654	98	Paved Impervious, HSG A
* 8,132	98	Paved Impervious, HSG B
2,071	39	>75% Grass cover, Good, HSG A
3,960	61	>75% Grass cover, Good, HSG B
13,634	30	Woods, Good, HSG A
13,023	55	Woods, Good, HSG B
44,474	59	Weighted Average
32,688		73.50% Pervious Area
11,786		26.50% Impervious Area

Tc (min)	Length (feet)	Slope (ft/ft)	Velocity (ft/sec)	Capacity (cfs)	Description
7.8	50	0.0600	0.11		<b>Sheet Flow,</b> Woods: Light underbrush n= 0.400 P2= 3.30"
2.5	120	0.0250	0.79		<b>Shallow Concentrated Flow,</b> Woodland Kv= 5.0 fps
2.4	293	0.0100	2.03		<b>Shallow Concentrated Flow,</b> Paved Kv= 20.3 fps
12.7	463	Total			

Subcatchment A4: SUB-A4

Hydrograph

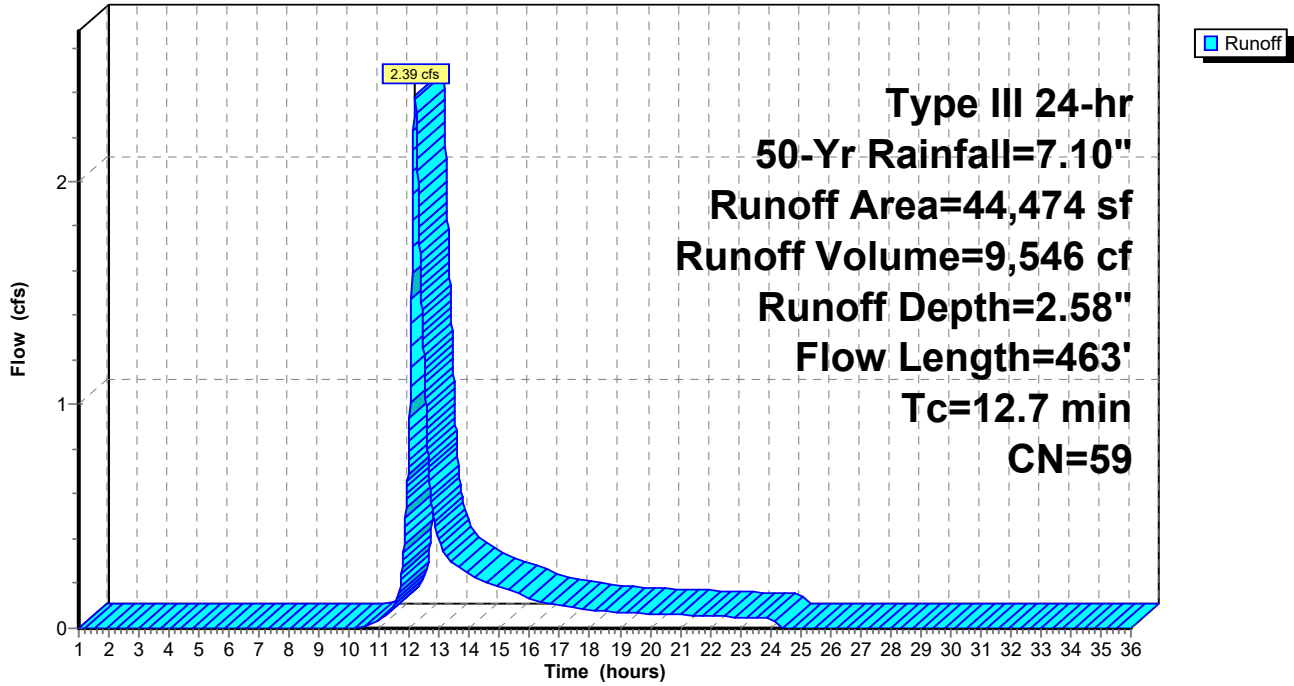

**Cole Pre-Development**

Prepared by Weston & Sampson

HydroCAD® 10.00-20 s/n 00455 © 2017 HydroCAD Software Solutions LLC

Type III 24-hr 50-Yr Rainfall=7.10"

Printed 4/6/2021

Page 42

**Summary for Subcatchment B1: SUB-B1**

Runoff = 1.65 cfs @ 12.09 hrs, Volume= 5,147 cf, Depth= 4.79"

Runoff by SCS TR-20 method, UH=SCS, Weighted-CN, Time Span= 1.00-36.00 hrs, dt= 0.01 hrs  
Type III 24-hr 50-Yr Rainfall=7.10"

	Area (sf)	CN	Description
*	6,295	98	Paved Impervious, HSG B
	969	98	Roofs, HSG A
	638	39	>75% Grass cover, Good, HSG A
	4,212	61	>75% Grass cover, Good, HSG B
	789	55	Woods, Good, HSG B
	12,903	80	Weighted Average
	5,639		43.70% Pervious Area
	7,264		56.30% Impervious Area

Tc (min)	Length (feet)	Slope (ft/ft)	Velocity (ft/sec)	Capacity (cfs)	Description
6.0					Direct Entry,

**Subcatchment B1: SUB-B1**

Hydrograph

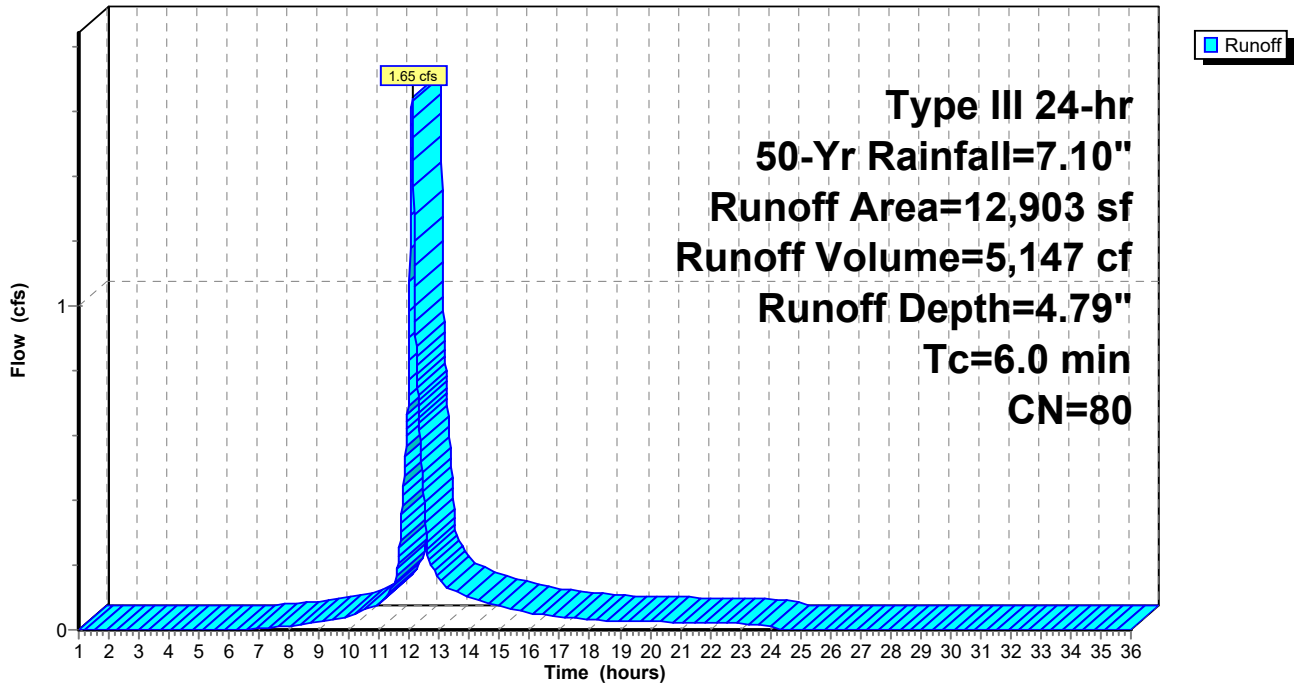



# Cole Pre-Development

Prepared by Weston & Sampson

HydroCAD® 10.00-20 s/n 00455 © 2017 HydroCAD Software Solutions LLC

Type III 24-hr 50-Yr Rainfall=7.10"

Printed 4/6/2021

Page 43

## Summary for Pond A: POI-A

Inflow Area = 289,843 sf, 51.53% Impervious, Inflow Depth = 4.12" for 50-Yr event  
Inflow = 28.12 cfs @ 12.11 hrs, Volume= 99,474 cf  
Primary = 28.12 cfs @ 12.11 hrs, Volume= 99,474 cf, Atten= 0%, Lag= 0.0 min

Routing by Dyn-Stor-Ind method, Time Span= 1.00-36.00 hrs, dt= 0.01 hrs / 2

### Pond A: POI-A

Hydrograph

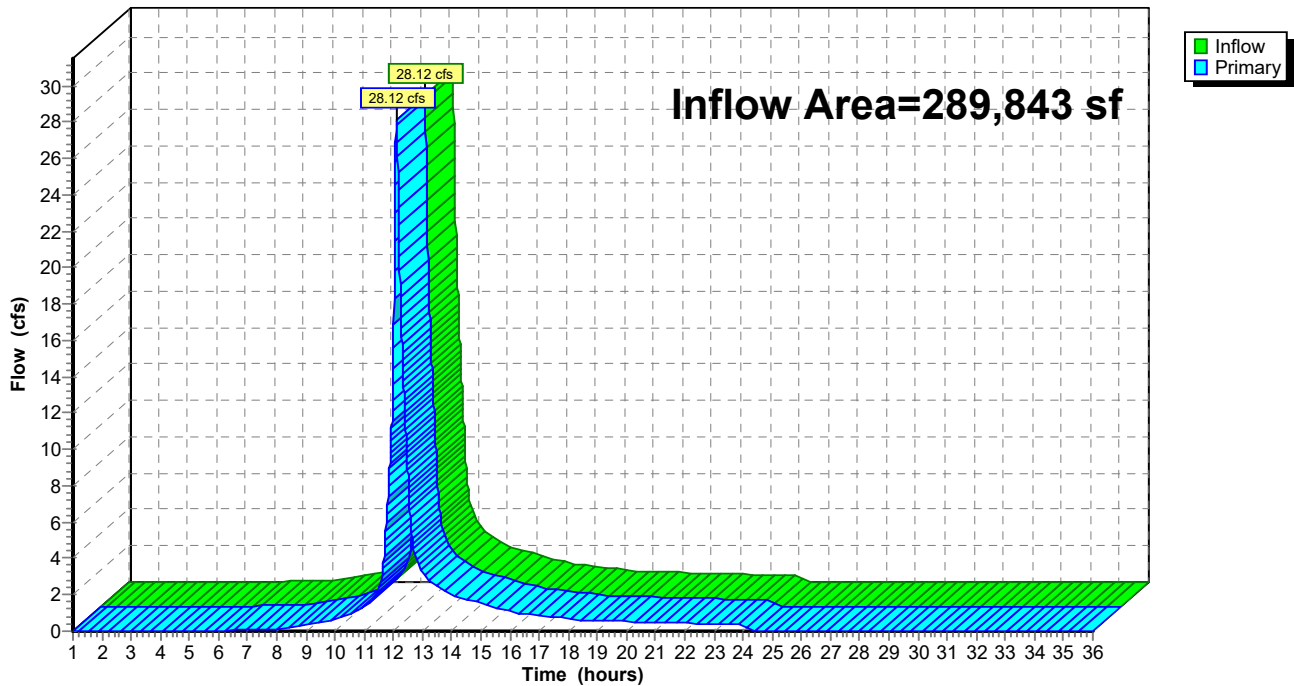

**Cole Pre-Development**

Prepared by Weston & Sampson

HydroCAD® 10.00-20 s/n 00455 © 2017 HydroCAD Software Solutions LLC

Type III 24-hr 50-Yr Rainfall=7.10"

Printed 4/6/2021

Page 44

**Summary for Pond B: POI-B**

Inflow Area = 12,903 sf, 56.30% Impervious, Inflow Depth = 4.79" for 50-Yr event  
Inflow = 1.65 cfs @ 12.09 hrs, Volume= 5,147 cf  
Primary = 1.65 cfs @ 12.09 hrs, Volume= 5,147 cf, Atten= 0%, Lag= 0.0 min

Routing by Dyn-Stor-Ind method, Time Span= 1.00-36.00 hrs, dt= 0.01 hrs / 2

**Pond B: POI-B**

Hydrograph

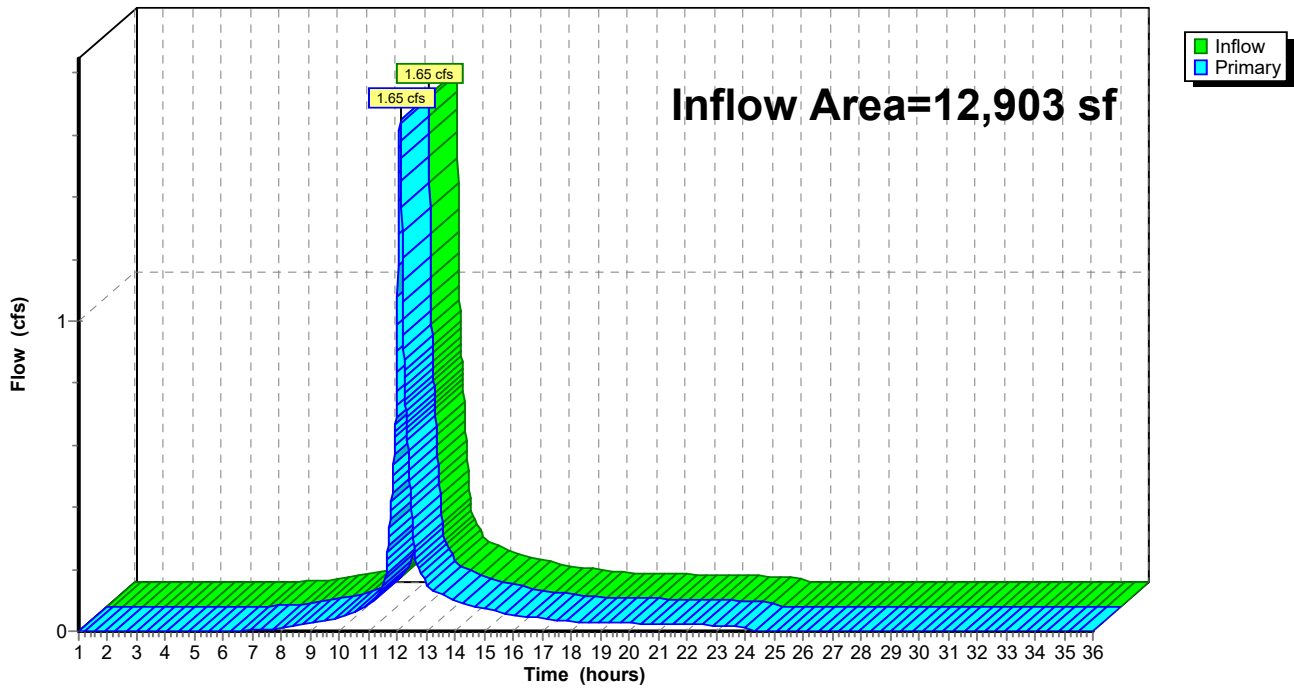

**Cole Pre-Development**

Prepared by Weston & Sampson

HydroCAD® 10.00-20 s/n 00455 © 2017 HydroCAD Software Solutions LLC

Type III 24-hr 100-Yr Rainfall=8.30"

Printed 4/6/2021

Page 45

Time span=1.00-36.00 hrs, dt=0.01 hrs, 3501 points x 2  
Runoff by SCS TR-20 method, UH=SCS, Weighted-CN  
Reach routing by Dyn-Stor-Ind method - Pond routing by Dyn-Stor-Ind method

**SubcatchmentA1: SUB-A1** Runoff Area=70,293 sf 66.46% Impervious Runoff Depth=6.62"  
Tc=6.0 min CN=86 Runoff=11.99 cfs 38,793 cf

**SubcatchmentA2: SUB-A2** Runoff Area=30,592 sf 58.29% Impervious Runoff Depth=5.31"  
Tc=6.0 min CN=75 Runoff=4.35 cfs 13,545 cf

**SubcatchmentA3: SUB-A3** Runoff Area=144,484 sf 50.55% Impervious Runoff Depth=4.96"  
Flow Length=152' Tc=9.3 min CN=72 Runoff=17.21 cfs 59,704 cf

**SubcatchmentA4: SUB-A4** Runoff Area=44,474 sf 26.50% Impervious Runoff Depth=3.45"  
Flow Length=463' Tc=12.7 min CN=59 Runoff=3.26 cfs 12,769 cf

**SubcatchmentB1: SUB-B1** Runoff Area=12,903 sf 56.30% Impervious Runoff Depth=5.91"  
Tc=6.0 min CN=80 Runoff=2.02 cfs 6,351 cf

**Pond A: POI-A** Inflow=35.17 cfs 124,811 cf  
Primary=35.17 cfs 124,811 cf

**Pond B: POI-B** Inflow=2.02 cfs 6,351 cf  
Primary=2.02 cfs 6,351 cf

**Total Runoff Area = 302,746 sf Runoff Volume = 131,162 cf Average Runoff Depth = 5.20"**  
**48.26% Pervious = 146,115 sf 51.74% Impervious = 156,631 sf**

**Cole Pre-Development**

Prepared by Weston & Sampson

HydroCAD® 10.00-20 s/n 00455 © 2017 HydroCAD Software Solutions LLC

Type III 24-hr 100-Yr Rainfall=8.30"

Printed 4/6/2021

Page 46

**Summary for Subcatchment A1: SUB-A1**

Runoff = 11.99 cfs @ 12.08 hrs, Volume= 38,793 cf, Depth= 6.62"

Runoff by SCS TR-20 method, UH=SCS, Weighted-CN, Time Span= 1.00-36.00 hrs, dt= 0.01 hrs  
Type III 24-hr 100-Yr Rainfall=8.30"

	Area (sf)	CN	Description
*	25,439	98	Paved Impervious, HSG B
	21,280	98	Roofs, HSG B
	22,661	61	>75% Grass cover, Good, HSG B
	913	55	Woods, Good, HSG B
	70,293	86	Weighted Average
	23,574		33.54% Pervious Area
	46,719		66.46% Impervious Area

Tc (min)	Length (feet)	Slope (ft/ft)	Velocity (ft/sec)	Capacity (cfs)	Description
6.0					Direct Entry,

**Subcatchment A1: SUB-A1**

Hydrograph

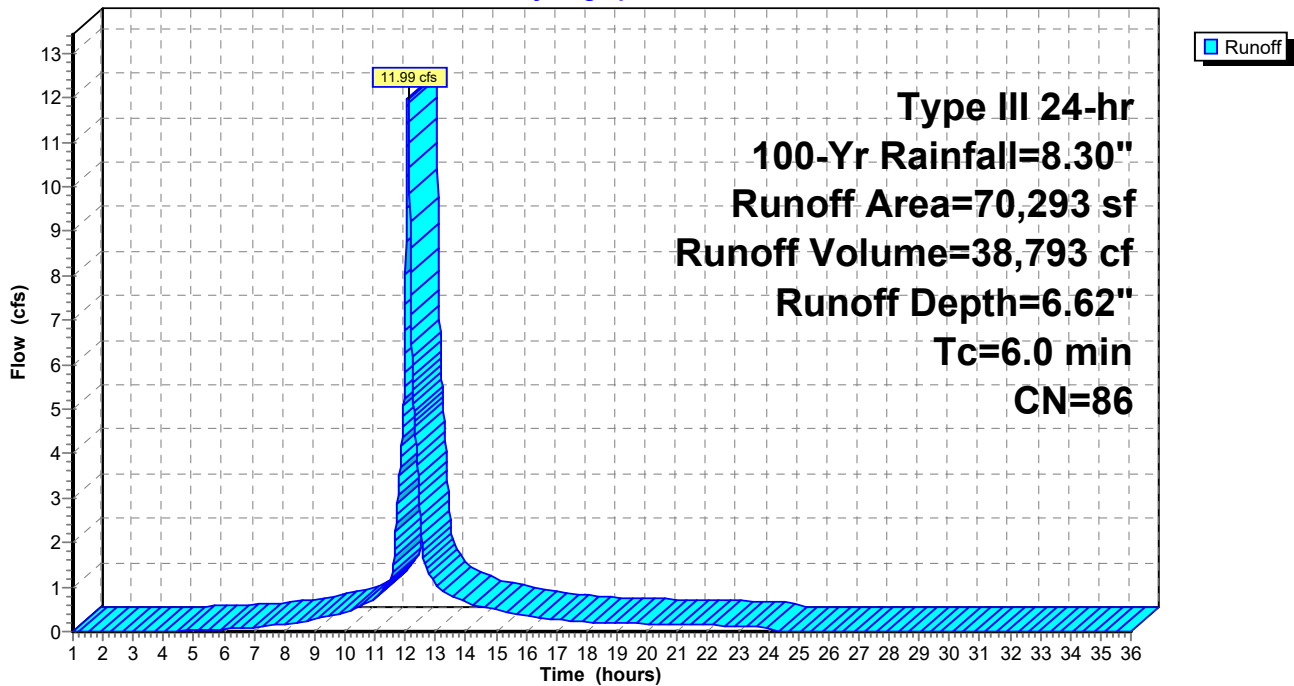

**Cole Pre-Development**

Prepared by Weston & Sampson

HydroCAD® 10.00-20 s/n 00455 © 2017 HydroCAD Software Solutions LLC

Type III 24-hr 100-Yr Rainfall=8.30"

Printed 4/6/2021

Page 47

**Summary for Subcatchment A2: SUB-A2**

Runoff = 4.35 cfs @ 12.09 hrs, Volume= 13,545 cf, Depth= 5.31"

Runoff by SCS TR-20 method, UH=SCS, Weighted-CN, Time Span= 1.00-36.00 hrs, dt= 0.01 hrs  
Type III 24-hr 100-Yr Rainfall=8.30"

	Area (sf)	CN	Description
*	14,124	98	Paved Impervious, HSG A
*	2,639	98	Paved Impervious, HSG B
	1,068	98	Roofs, HSG A
	11,139	39	>75% Grass cover, Good, HSG A
	1,622	61	>75% Grass cover, Good, HSG B
	30,592	75	Weighted Average
	12,761		41.71% Pervious Area
	17,831		58.29% Impervious Area

Tc (min)	Length (feet)	Slope (ft/ft)	Velocity (ft/sec)	Capacity (cfs)	Description
6.0					Direct Entry,

**Subcatchment A2: SUB-A2**

Hydrograph

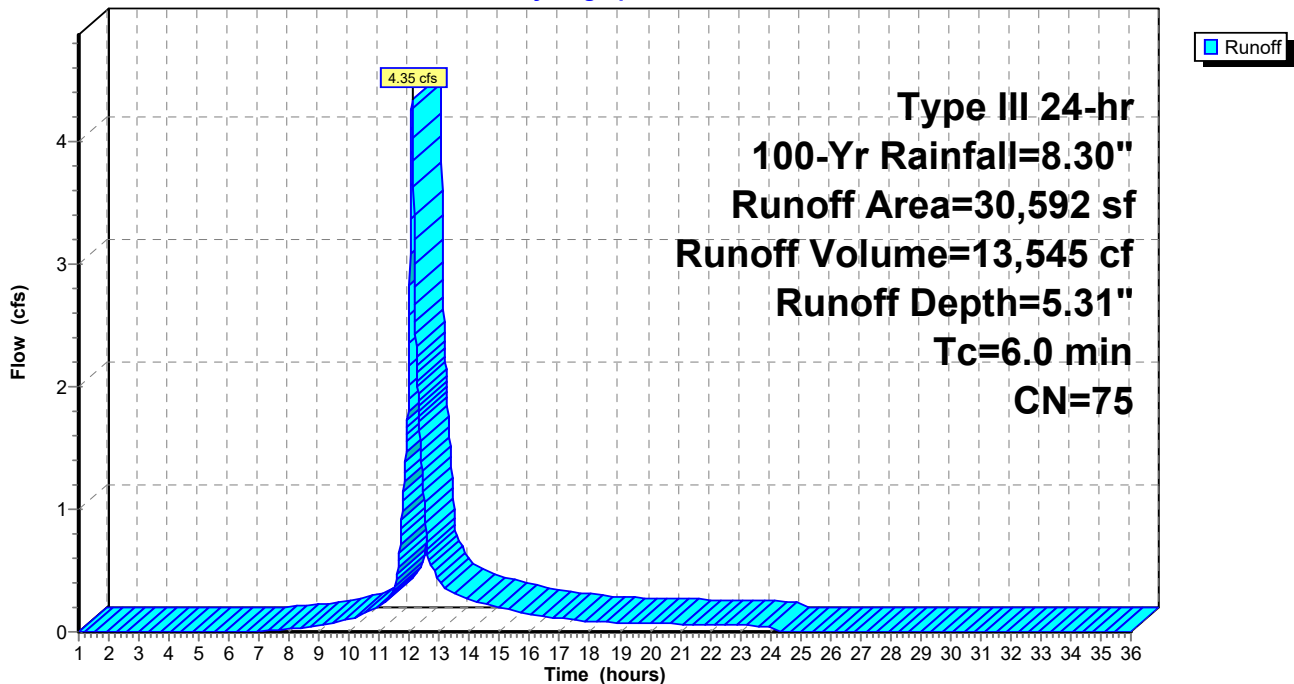

# Cole Pre-Development

Prepared by Weston & Sampson

HydroCAD® 10.00-20 s/n 00455 © 2017 HydroCAD Software Solutions LLC

Type III 24-hr 100-Yr Rainfall=8.30"

Printed 4/6/2021

Page 48

## Summary for Subcatchment A3: SUB-A3

Runoff = 17.21 cfs @ 12.13 hrs, Volume= 59,704 cf, Depth= 4.96"

Runoff by SCS TR-20 method, UH=SCS, Weighted-CN, Time Span= 1.00-36.00 hrs, dt= 0.01 hrs  
Type III 24-hr 100-Yr Rainfall=8.30"

	Area (sf)	CN	Description
*	26,940	98	Paved Impervious, HSG A
*	23,438	98	Paved Impervious, HSG B
	20,776	39	>75% Grass cover, Good, HSG A
	23,581	61	>75% Grass cover, Good, HSG B
	19,969	30	Woods, Good, HSG A
	7,127	55	Woods, Good, HSG B
	5,397	98	Roofs, HSG A
	17,256	98	Roofs, HSG B
	144,484	72	Weighted Average
	71,453		49.45% Pervious Area
	73,031		50.55% Impervious Area

Tc (min)	Length (feet)	Slope (ft/ft)	Velocity (ft/sec)	Capacity (cfs)	Description
7.8	50	0.0600	0.11		<b>Sheet Flow,</b> Woods: Light underbrush n= 0.400 P2= 3.30"
0.7	41	0.0340	0.92		<b>Shallow Concentrated Flow,</b> Woodland Kv= 5.0 fps
0.8	61	0.0340	1.29		<b>Shallow Concentrated Flow,</b> Short Grass Pasture Kv= 7.0 fps
9.3	152	Total			

Subcatchment A3: SUB-A3

Hydrograph

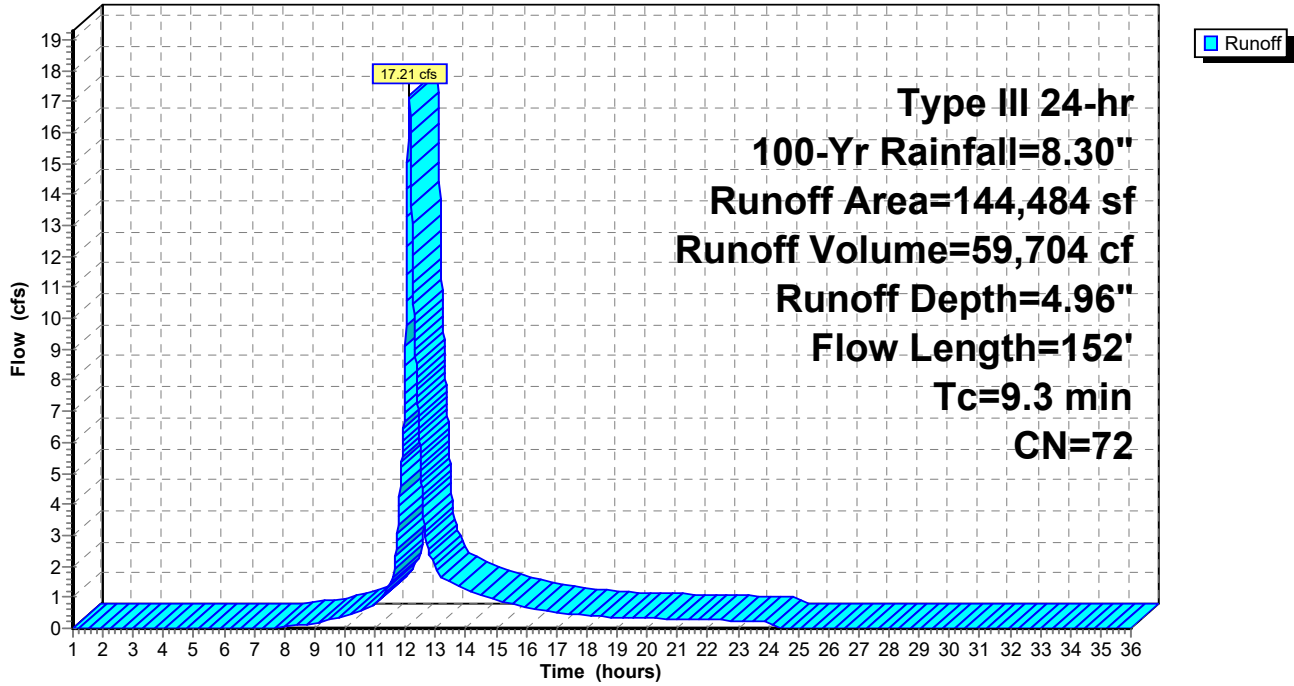

# Cole Pre-Development

Prepared by Weston & Sampson

HydroCAD® 10.00-20 s/n 00455 © 2017 HydroCAD Software Solutions LLC

Type III 24-hr 100-Yr Rainfall=8.30"

Printed 4/6/2021

Page 50

## Summary for Subcatchment A4: SUB-A4

Runoff = 3.26 cfs @ 12.18 hrs, Volume= 12,769 cf, Depth= 3.45"

Runoff by SCS TR-20 method, UH=SCS, Weighted-CN, Time Span= 1.00-36.00 hrs, dt= 0.01 hrs  
Type III 24-hr 100-Yr Rainfall=8.30"

Area (sf)	CN	Description
* 3,654	98	Paved Impervious, HSG A
* 8,132	98	Paved Impervious, HSG B
2,071	39	>75% Grass cover, Good, HSG A
3,960	61	>75% Grass cover, Good, HSG B
13,634	30	Woods, Good, HSG A
13,023	55	Woods, Good, HSG B
44,474	59	Weighted Average
32,688		73.50% Pervious Area
11,786		26.50% Impervious Area

Tc (min)	Length (feet)	Slope (ft/ft)	Velocity (ft/sec)	Capacity (cfs)	Description
7.8	50	0.0600	0.11		<b>Sheet Flow,</b> Woods: Light underbrush n= 0.400 P2= 3.30"
2.5	120	0.0250	0.79		<b>Shallow Concentrated Flow,</b> Woodland Kv= 5.0 fps
2.4	293	0.0100	2.03		<b>Shallow Concentrated Flow,</b> Paved Kv= 20.3 fps
12.7	463	Total			



Subcatchment A4: SUB-A4

Hydrograph

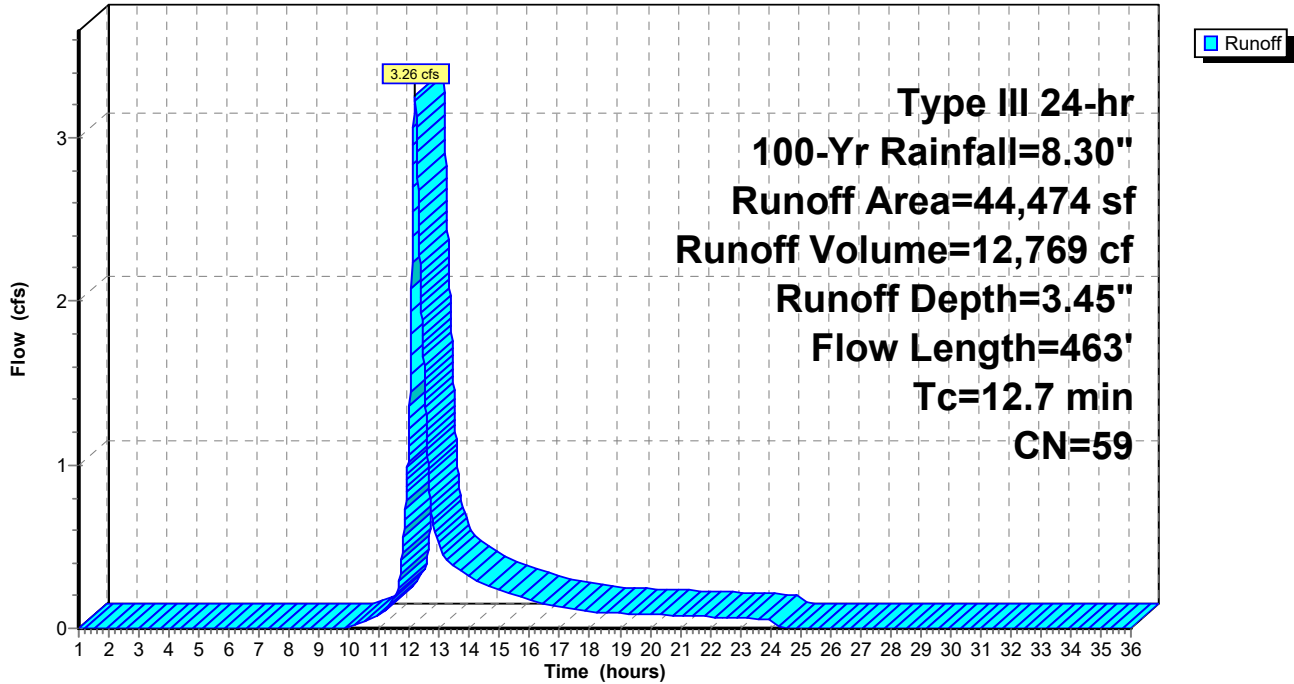

**Cole Pre-Development**

Prepared by Weston & Sampson

HydroCAD® 10.00-20 s/n 00455 © 2017 HydroCAD Software Solutions LLC

Type III 24-hr 100-Yr Rainfall=8.30"

Printed 4/6/2021

Page 52

**Summary for Subcatchment B1: SUB-B1**

Runoff = 2.02 cfs @ 12.09 hrs, Volume= 6,351 cf, Depth= 5.91"

Runoff by SCS TR-20 method, UH=SCS, Weighted-CN, Time Span= 1.00-36.00 hrs, dt= 0.01 hrs  
 Type III 24-hr 100-Yr Rainfall=8.30"

Area (sf)	CN	Description
* 6,295	98	Paved Impervious, HSG B
969	98	Roofs, HSG A
638	39	>75% Grass cover, Good, HSG A
4,212	61	>75% Grass cover, Good, HSG B
789	55	Woods, Good, HSG B
12,903	80	Weighted Average
5,639		43.70% Pervious Area
7,264		56.30% Impervious Area

Tc (min)	Length (feet)	Slope (ft/ft)	Velocity (ft/sec)	Capacity (cfs)	Description
6.0					Direct Entry,

**Subcatchment B1: SUB-B1**

Hydrograph

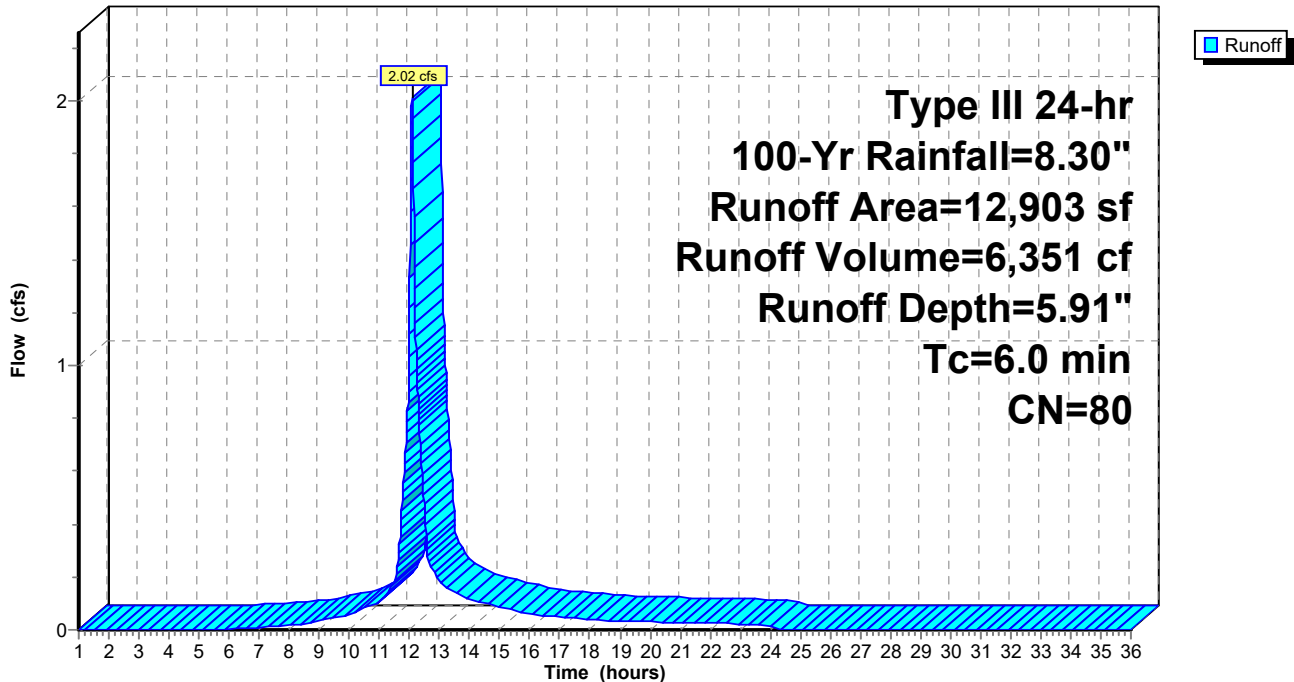

**Cole Pre-Development**

Prepared by Weston & Sampson

HydroCAD® 10.00-20 s/n 00455 © 2017 HydroCAD Software Solutions LLC

Type III 24-hr 100-Yr Rainfall=8.30"

Printed 4/6/2021

Page 53

**Summary for Pond A: POI-A**

Inflow Area = 289,843 sf, 51.53% Impervious, Inflow Depth = 5.17" for 100-Yr event  
Inflow = 35.17 cfs @ 12.11 hrs, Volume= 124,811 cf  
Primary = 35.17 cfs @ 12.11 hrs, Volume= 124,811 cf, Atten= 0%, Lag= 0.0 min

Routing by Dyn-Stor-Ind method, Time Span= 1.00-36.00 hrs, dt= 0.01 hrs / 2

**Pond A: POI-A**

Hydrograph

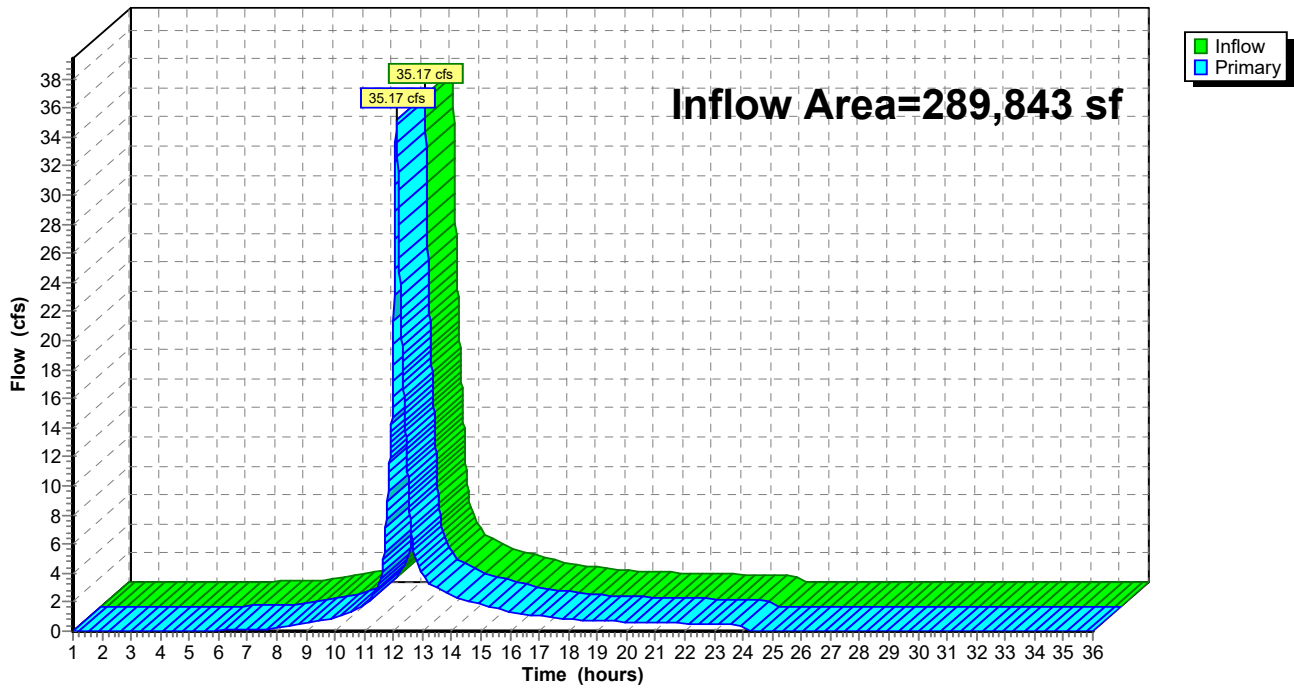

**Cole Pre-Development**

Prepared by Weston & Sampson

HydroCAD® 10.00-20 s/n 00455 © 2017 HydroCAD Software Solutions LLC

Type III 24-hr 100-Yr Rainfall=8.30"

Printed 4/6/2021

Page 54

**Summary for Pond B: POI-B**

Inflow Area = 12,903 sf, 56.30% Impervious, Inflow Depth = 5.91" for 100-Yr event  
Inflow = 2.02 cfs @ 12.09 hrs, Volume= 6,351 cf  
Primary = 2.02 cfs @ 12.09 hrs, Volume= 6,351 cf, Atten= 0%, Lag= 0.0 min

Routing by Dyn-Stor-Ind method, Time Span= 1.00-36.00 hrs, dt= 0.01 hrs / 2

**Pond B: POI-B**

Hydrograph

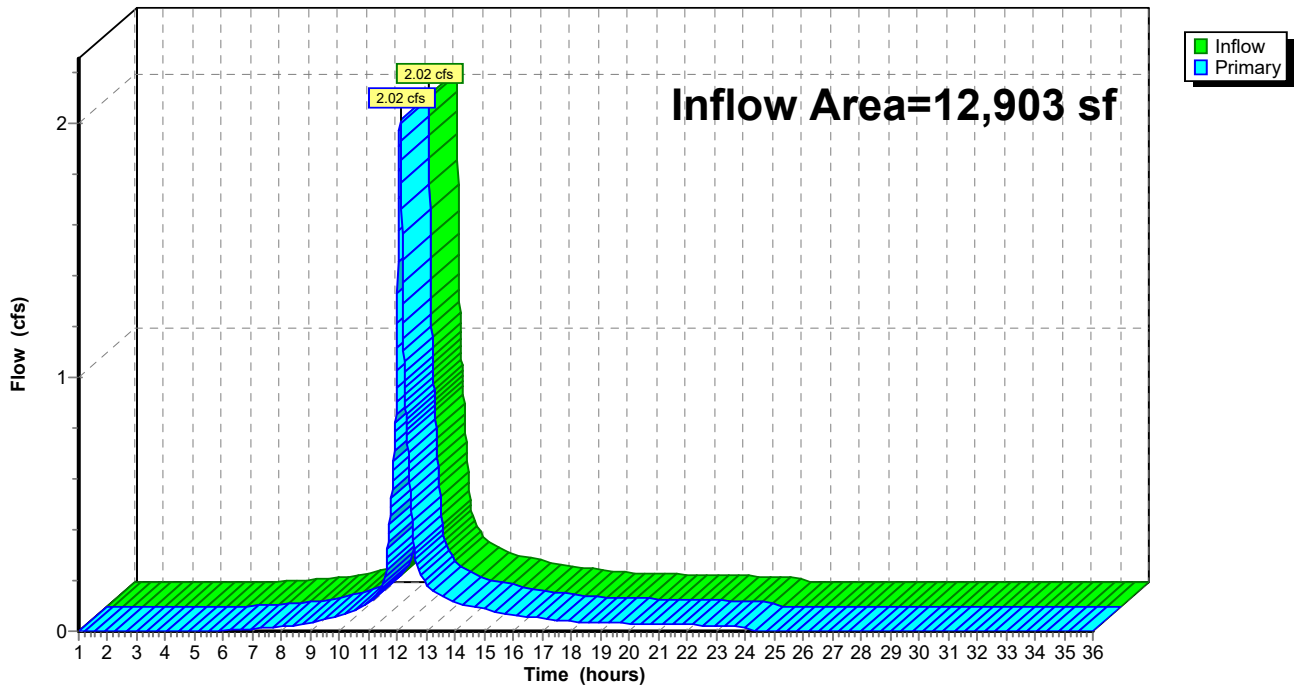

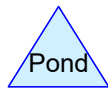
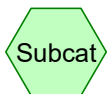
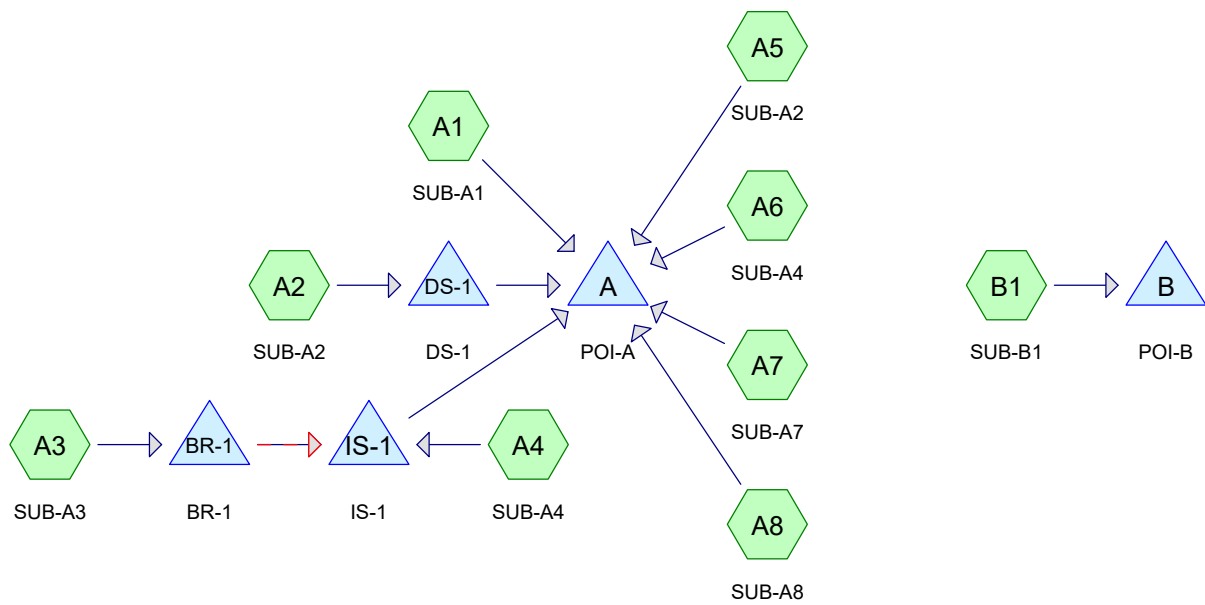

## Cole Post-Development

Prepared by Weston & Sampson

HydroCAD® 10.10-5a s/n 00455 © 2020 HydroCAD Software Solutions LLC

Printed 7/12/2021

Page 2

### Rainfall Events Listing (selected events)

Event#	Event Name	Storm Type	Curve	Mode	Duration (hours)	B/B	Depth (inches)	AMC
1	2-year	Type III 24-hr		Default	24.00	1	3.10	2
2	10-year	Type III 24-hr		Default	24.00	1	4.70	2
3	25-year	Type III 24-hr		Default	24.00	1	5.80	2
4	50-year	Type III 24-hr		Default	24.00	1	7.10	2
5	100-year	Type III 24-hr		Default	24.00	1	8.30	2

## Cole Post-Development

Prepared by Weston & Sampson

HydroCAD® 10.10-5a s/n 00455 © 2020 HydroCAD Software Solutions LLC

Printed 7/12/2021

Page 3

### Area Listing (all nodes)

Area (sq-ft)	CN	Description (subcatchment-numbers)
27,962	39	>75% Grass cover, Good, HSG A (A2, A3, A4, A5, A6, A7, A8)
56,095	61	>75% Grass cover, Good, HSG B (A1, A2, A3, A4, A6, A7, B1)
51,224	98	Paved Impervious, HSG A (A2, A3, A4, A5, A6, A8)
66,040	98	Paved Impervious, HSG B (A1, A2, A3, A4, A5, A6, A7, A8)
7,434	98	Roofs, HSG A (A4, A8)
38,536	98	Roofs, HSG B (A1, A2, A3, A4, A8)
33,603	30	Woods, Good, HSG A (A2, A6, A7, A8)
21,852	55	Woods, Good, HSG B (A1, A2, A6, A7, B1)
<b>302,746</b>	<b>75</b>	<b>TOTAL AREA</b>

# Cole Post-Development

Prepared by Weston & Sampson

HydroCAD® 10.10-5a s/n 00455 © 2020 HydroCAD Software Solutions LLC

Printed 7/12/2021

Page 4

## Soil Listing (all nodes)

Area (sq-ft)	Soil Group	Subcatchment Numbers
120,223	HSG A	A2, A3, A4, A5, A6, A7, A8
182,523	HSG B	A1, A2, A3, A4, A5, A6, A7, A8, B1
0	HSG C	
0	HSG D	
0	Other	
<b>302,746</b>		<b>TOTAL AREA</b>



# Cole Post-Development

Prepared by Weston & Sampson

HydroCAD® 10.10-5a s/n 00455 © 2020 HydroCAD Software Solutions LLC

Printed 7/12/2021

Page 5

## Ground Covers (all nodes)

HSG-A (sq-ft)	HSG-B (sq-ft)	HSG-C (sq-ft)	HSG-D (sq-ft)	Other (sq-ft)	Total (sq-ft)	Ground Cover
27,962	56,095	0	0	0	84,057	>75% Grass cover, Good
51,224	66,040	0	0	0	117,264	Paved Impervious
7,434	38,536	0	0	0	45,970	Roofs
33,603	21,852	0	0	0	55,455	Woods, Good
<b>120,223</b>	<b>182,523</b>	<b>0</b>	<b>0</b>	<b>0</b>	<b>302,746</b>	<b>TOTAL AREA</b>

## Cole Post-Development

Prepared by Weston & Sampson

HydroCAD® 10.10-5a s/n 00455 © 2020 HydroCAD Software Solutions LLC

Printed 7/12/2021

Page 6

### Pipe Listing (all nodes)

Line#	Node Number	In-Invert (feet)	Out-Invert (feet)	Length (feet)	Slope (ft/ft)	n	Width (inches)	Diam/Height (inches)	Inside-Fill (inches)
1	BR-1	94.49	94.18	62.8	0.0049	0.130	0.0	12.0	0.0
2	DS-1	88.25	88.12	26.9	0.0048	0.013	0.0	24.0	0.0
3	IS-1	92.00	91.09	91.3	0.0100	0.013	0.0	12.0	0.0

**Cole Post-Development**

Type III 24-hr 2-year Rainfall=3.10"

Prepared by Weston &amp; Sampson

Printed 7/12/2021

HydroCAD® 10.10-5a s/n 00455 © 2020 HydroCAD Software Solutions LLC

Page 7

Time span=1.00-36.00 hrs, dt=0.01 hrs, 3501 points  
 Runoff by SCS TR-20 method, UH=SCS, Weighted-CN  
 Reach routing by Dyn-Stor-Ind method - Pond routing by Dyn-Stor-Ind method

<b>SubcatchmentA1: SUB-A1</b>	Runoff Area=67,238 sf 64.49% Impervious Runoff Depth=1.67" Tc=6.0 min CN=85 Runoff=3.03 cfs 9,372 cf
<b>SubcatchmentA2: SUB-A2</b>	Runoff Area=35,193 sf 61.85% Impervious Runoff Depth=1.14" Flow Length=160' Tc=8.9 min CN=77 Runoff=0.95 cfs 3,346 cf
<b>SubcatchmentA3: SUB-A3</b>	Runoff Area=16,500 sf 77.45% Impervious Runoff Depth=1.75" Tc=6.0 min CN=86 Runoff=0.78 cfs 2,404 cf
<b>SubcatchmentA4: SUB-A4</b>	Runoff Area=45,097 sf 88.28% Impervious Runoff Depth=2.26" Tc=6.0 min CN=92 Runoff=2.68 cfs 8,477 cf
<b>SubcatchmentA5: SUB-A2</b>	Runoff Area=11,510 sf 59.26% Impervious Runoff Depth=0.97" Tc=6.0 min CN=74 Runoff=0.28 cfs 933 cf
<b>SubcatchmentA6: SUB-A4</b>	Runoff Area=44,811 sf 26.24% Impervious Runoff Depth=0.31" Flow Length=463' Tc=12.7 min CN=58 Runoff=0.14 cfs 1,146 cf
<b>SubcatchmentA7: SUB-A7</b>	Runoff Area=31,077 sf 11.00% Impervious Runoff Depth=0.37" Tc=6.0 min CN=60 Runoff=0.16 cfs 958 cf
<b>SubcatchmentA8: SUB-A8</b>	Runoff Area=45,413 sf 51.78% Impervious Runoff Depth=0.68" Flow Length=136' Tc=7.4 min CN=68 Runoff=0.66 cfs 2,569 cf
<b>SubcatchmentB1: SUB-B1</b>	Runoff Area=5,907 sf 0.00% Impervious Runoff Depth=0.37" Tc=6.0 min CN=60 Runoff=0.03 cfs 182 cf
<b>Pond A: POI-A</b>	Inflow=4.30 cfs 18,335 cf Primary=4.30 cfs 18,335 cf
<b>Pond B: POI-B</b>	Inflow=0.03 cfs 182 cf Primary=0.03 cfs 182 cf
<b>Pond BR-1: BR-1</b>	Peak Elev=100.85' Storage=833 cf Inflow=0.78 cfs 2,404 cf Primary=0.63 cfs 1,594 cf Secondary=0.00 cfs 0 cf Outflow=0.63 cfs 1,594 cf
<b>Pond DS-1: DS-1</b>	Peak Elev=90.00' Storage=753 cf Inflow=0.95 cfs 3,346 cf Outflow=0.46 cfs 3,345 cf
<b>Pond IS-1: IS-1</b>	Peak Elev=94.24' Storage=4,071 cf Inflow=2.80 cfs 10,071 cf Discarded=0.23 cfs 10,059 cf Primary=0.00 cfs 13 cf Outflow=0.23 cfs 10,071 cf

**Total Runoff Area = 302,746 sf Runoff Volume = 29,387 cf Average Runoff Depth = 1.16"**  
**46.08% Pervious = 139,512 sf 53.92% Impervious = 163,234 sf**

**Cole Post-Development**

Prepared by Weston & Sampson

HydroCAD® 10.10-5a s/n 00455 © 2020 HydroCAD Software Solutions LLC

Type III 24-hr 2-year Rainfall=3.10"

Printed 7/12/2021

Page 8

**Summary for Subcatchment A1: SUB-A1**

Runoff = 3.03 cfs @ 12.09 hrs, Volume= 9,372 cf, Depth= 1.67"

Runoff by SCS TR-20 method, UH=SCS, Weighted-CN, Time Span= 1.00-36.00 hrs, dt= 0.01 hrs  
Type III 24-hr 2-year Rainfall=3.10"

	Area (sf)	CN	Description
*	27,200	98	Paved Impervious, HSG B
	16,163	98	Roofs, HSG B
	23,006	61	>75% Grass cover, Good, HSG B
	869	55	Woods, Good, HSG B
	67,238	85	Weighted Average
	23,875		35.51% Pervious Area
	43,363		64.49% Impervious Area

Tc (min)	Length (feet)	Slope (ft/ft)	Velocity (ft/sec)	Capacity (cfs)	Description
6.0					Direct Entry,

**Subcatchment A1: SUB-A1**

Hydrograph

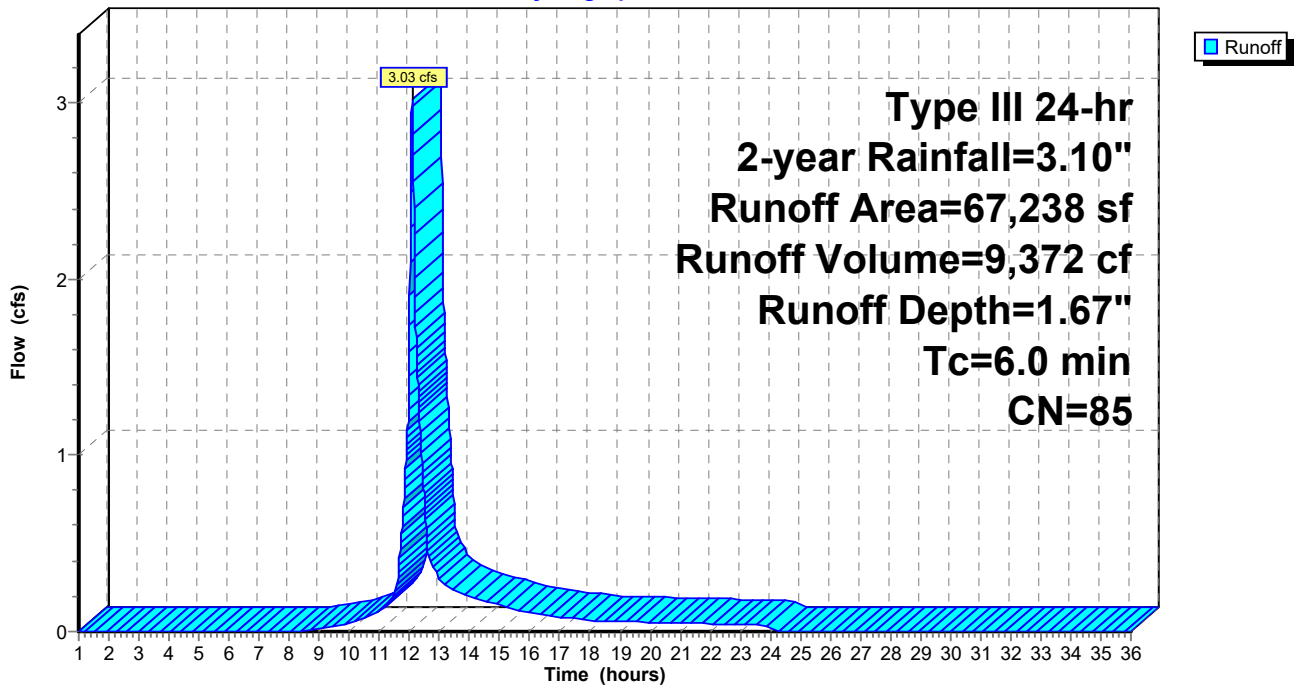

**Cole Post-Development**

Prepared by Weston & Sampson

HydroCAD® 10.10-5a s/n 00455 © 2020 HydroCAD Software Solutions LLC

Type III 24-hr 2-year Rainfall=3.10"

Printed 7/12/2021

Page 9

**Summary for Subcatchment A2: SUB-A2**

Runoff = 0.95 cfs @ 12.13 hrs, Volume= 3,346 cf, Depth= 1.14"

Runoff by SCS TR-20 method, UH=SCS, Weighted-CN, Time Span= 1.00-36.00 hrs, dt= 0.01 hrs  
 Type III 24-hr 2-year Rainfall=3.10"

Area (sf)	CN	Description
* 23	98	Paved Impervious, HSG A
* 18,246	98	Paved Impervious, HSG B
3,498	98	Roofs, HSG B
1,694	39	>75% Grass cover, Good, HSG A
4,693	61	>75% Grass cover, Good, HSG B
6,952	30	Woods, Good, HSG A
87	55	Woods, Good, HSG B
35,193	77	Weighted Average
13,426		38.15% Pervious Area
21,767		61.85% Impervious Area

Tc (min)	Length (feet)	Slope (ft/ft)	Velocity (ft/sec)	Capacity (cfs)	Description
7.4	50	0.0700	0.11		<b>Sheet Flow,</b> Woods: Light underbrush n= 0.400 P2= 3.30"
0.5	33	0.0450	1.06		<b>Shallow Concentrated Flow,</b> Woodland Kv= 5.0 fps
0.9	59	0.0250	1.11		<b>Shallow Concentrated Flow,</b> Short Grass Pasture Kv= 7.0 fps
0.1	18	0.0150	2.49		<b>Shallow Concentrated Flow,</b> Paved Kv= 20.3 fps
8.9	160	Total			

**Subcatchment A2: SUB-A2**

Hydrograph

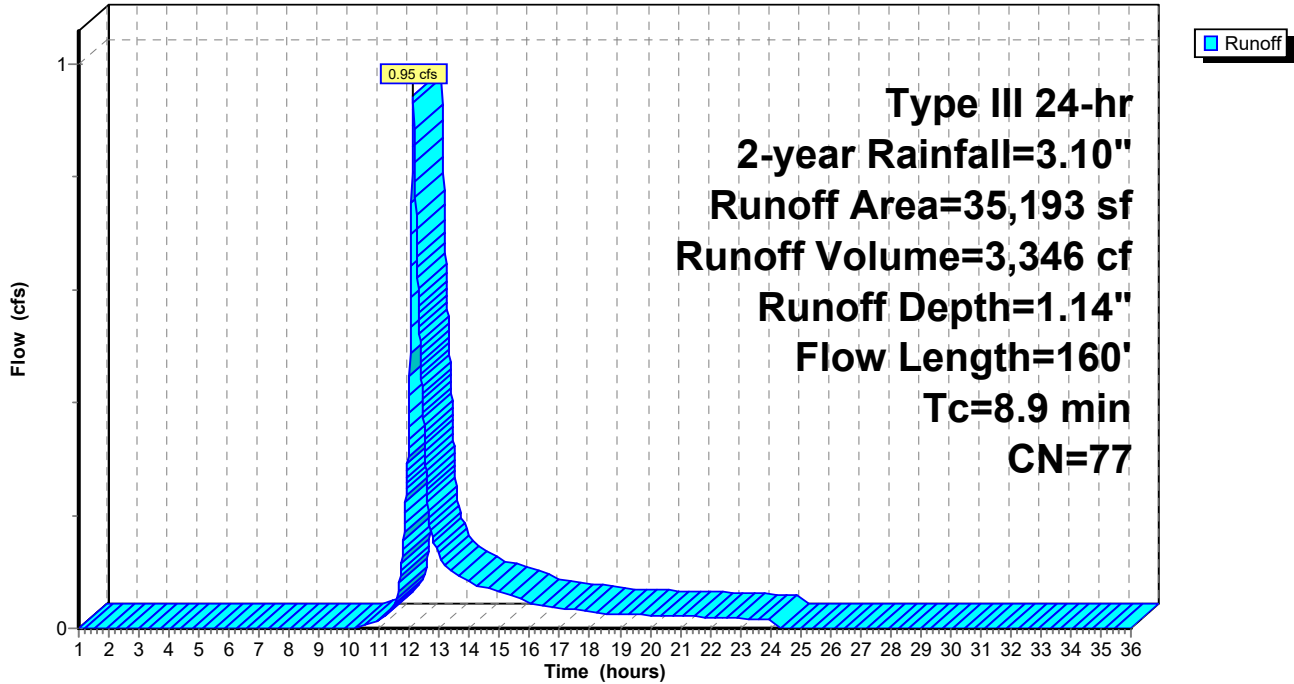

**Cole Post-Development**

Prepared by Weston & Sampson

HydroCAD® 10.10-5a s/n 00455 © 2020 HydroCAD Software Solutions LLC

Type III 24-hr 2-year Rainfall=3.10"

Printed 7/12/2021

Page 11

**Summary for Subcatchment A3: SUB-A3**

Runoff = 0.78 cfs @ 12.09 hrs, Volume= 2,404 cf, Depth= 1.75"

Runoff by SCS TR-20 method, UH=SCS, Weighted-CN, Time Span= 1.00-36.00 hrs, dt= 0.01 hrs  
Type III 24-hr 2-year Rainfall=3.10"

	Area (sf)	CN	Description
*	4,196	98	Paved Impervious, HSG A
*	1,717	98	Paved Impervious, HSG B
	6,866	98	Roofs, HSG B
	2,808	39	>75% Grass cover, Good, HSG A
	913	61	>75% Grass cover, Good, HSG B
	16,500	86	Weighted Average
	3,721		22.55% Pervious Area
	12,779		77.45% Impervious Area

Tc (min)	Length (feet)	Slope (ft/ft)	Velocity (ft/sec)	Capacity (cfs)	Description
6.0					Direct Entry,

**Subcatchment A3: SUB-A3**

Hydrograph

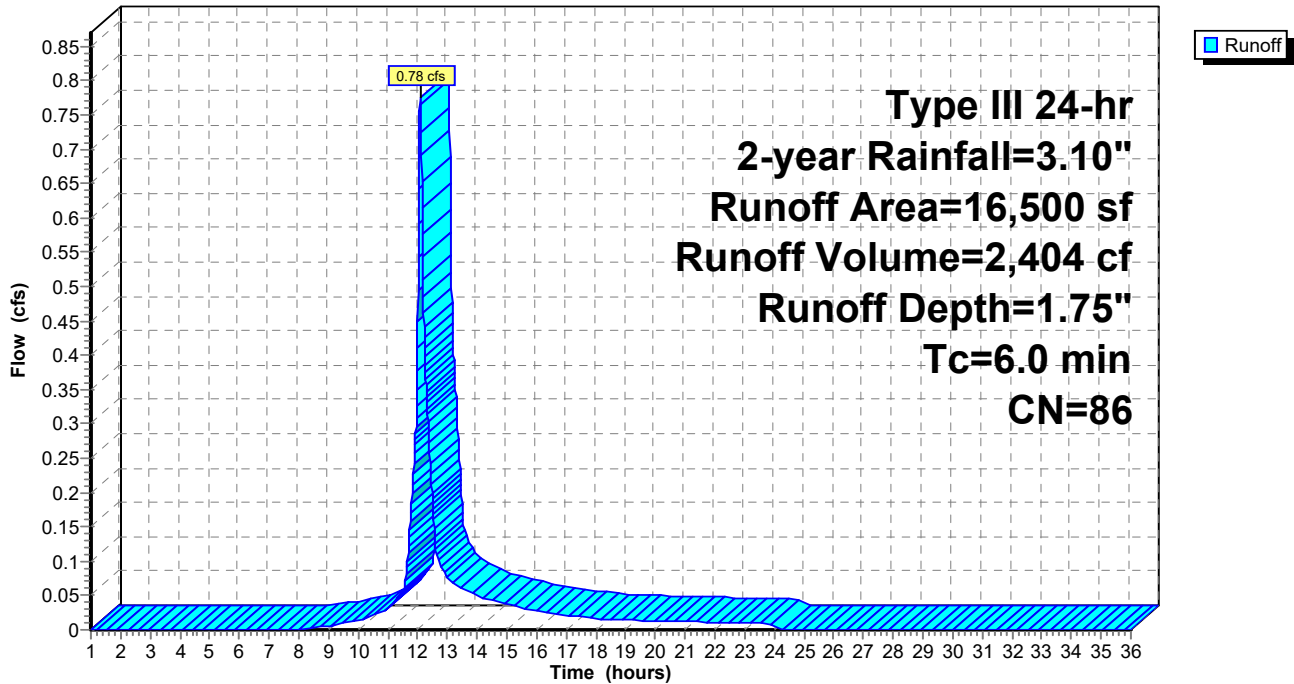

**Cole Post-Development**

Prepared by Weston & Sampson

HydroCAD® 10.10-5a s/n 00455 © 2020 HydroCAD Software Solutions LLC

Type III 24-hr 2-year Rainfall=3.10"

Printed 7/12/2021

Page 12

**Summary for Subcatchment A4: SUB-A4**

Runoff = 2.68 cfs @ 12.09 hrs, Volume= 8,477 cf, Depth= 2.26"

Runoff by SCS TR-20 method, UH=SCS, Weighted-CN, Time Span= 1.00-36.00 hrs, dt= 0.01 hrs  
Type III 24-hr 2-year Rainfall=3.10"

	Area (sf)	CN	Description
*	28,479	98	Paved Impervious, HSG A
*	4,701	98	Paved Impervious, HSG B
	3,540	98	Roofs, HSG A
	3,092	98	Roofs, HSG B
	3,675	39	>75% Grass cover, Good, HSG A
	1,610	61	>75% Grass cover, Good, HSG B
	45,097	92	Weighted Average
	5,285		11.72% Pervious Area
	39,812		88.28% Impervious Area

Tc (min)	Length (feet)	Slope (ft/ft)	Velocity (ft/sec)	Capacity (cfs)	Description
6.0					Direct Entry,

**Subcatchment A4: SUB-A4**

Hydrograph

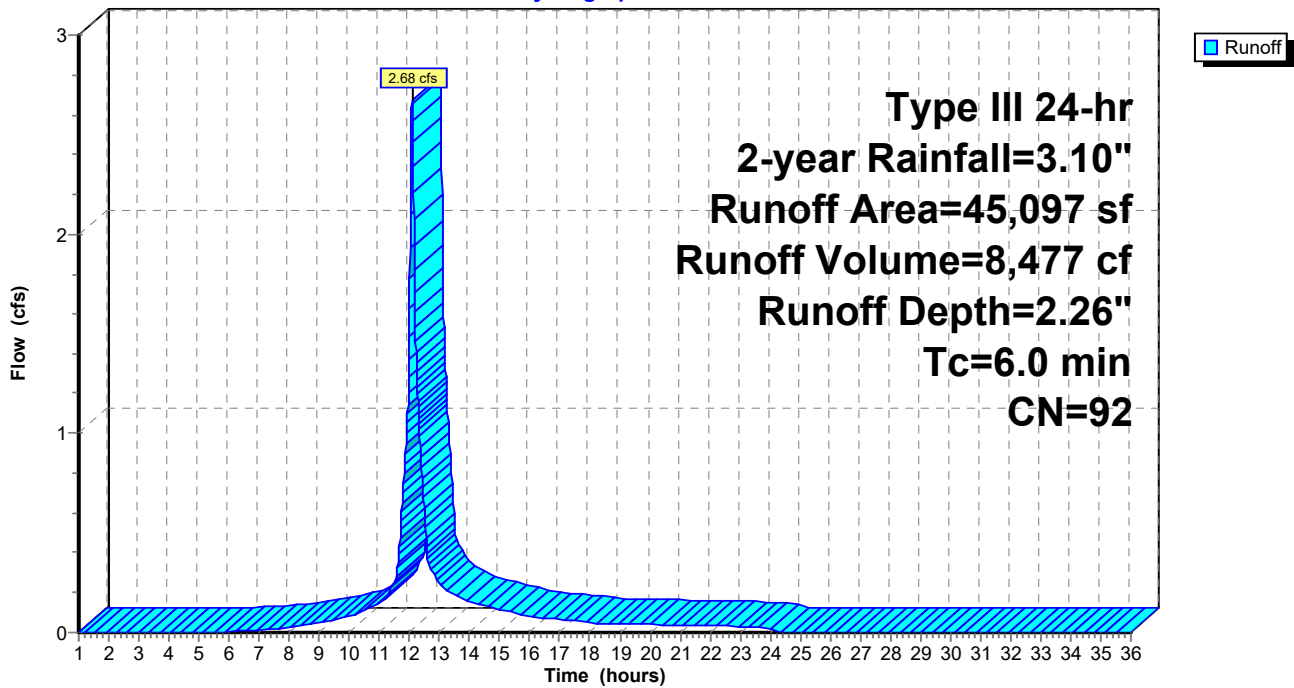



**Cole Post-Development**

Prepared by Weston & Sampson

HydroCAD® 10.10-5a s/n 00455 © 2020 HydroCAD Software Solutions LLC

Type III 24-hr 2-year Rainfall=3.10"

Printed 7/12/2021

Page 13

**Summary for Subcatchment A5: SUB-A2**

Runoff = 0.28 cfs @ 12.10 hrs, Volume= 933 cf, Depth= 0.97"

Runoff by SCS TR-20 method, UH=SCS, Weighted-CN, Time Span= 1.00-36.00 hrs, dt= 0.01 hrs  
Type III 24-hr 2-year Rainfall=3.10"

	Area (sf)	CN	Description
*	5,725	98	Paved Impervious, HSG A
*	1,096	98	Paved Impervious, HSG B
	4,689	39	>75% Grass cover, Good, HSG A
	11,510	74	Weighted Average
	4,689		40.74% Pervious Area
	6,821		59.26% Impervious Area

Tc (min)	Length (feet)	Slope (ft/ft)	Velocity (ft/sec)	Capacity (cfs)	Description
6.0					Direct Entry,

**Subcatchment A5: SUB-A2**

Hydrograph

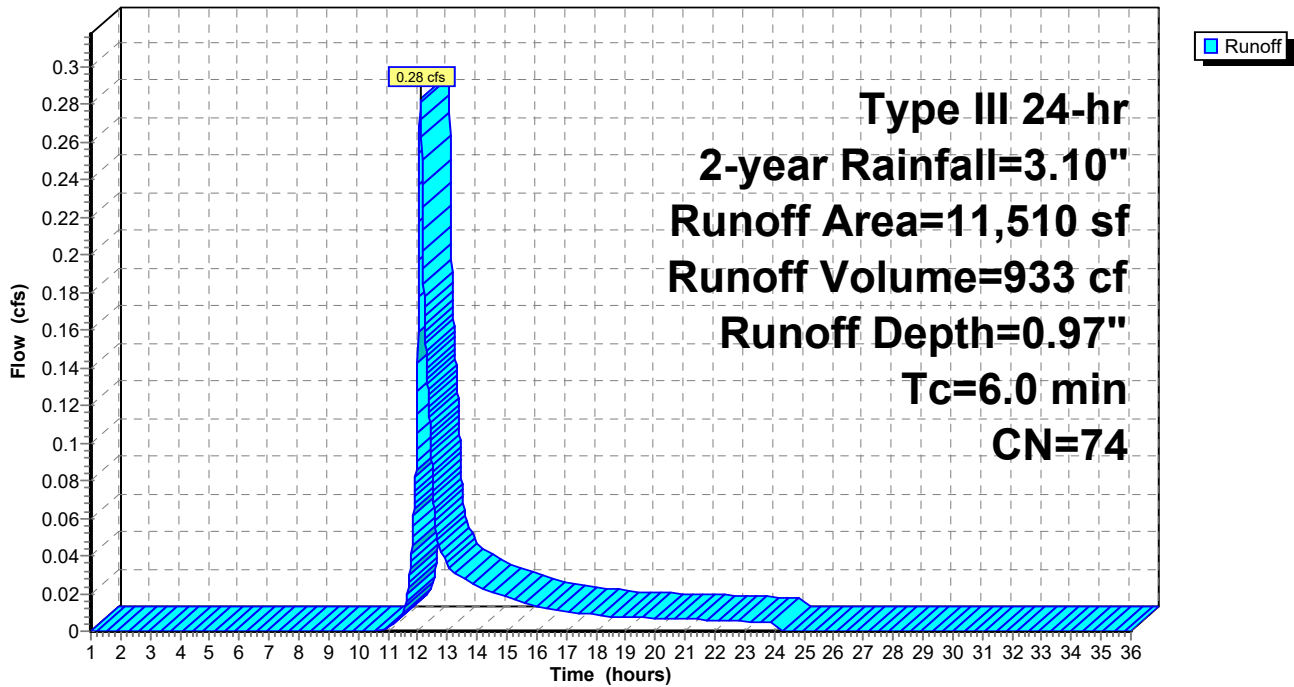

# Cole Post-Development

Prepared by Weston & Sampson

HydroCAD® 10.10-5a s/n 00455 © 2020 HydroCAD Software Solutions LLC

Type III 24-hr 2-year Rainfall=3.10"

Printed 7/12/2021

Page 14

## Summary for Subcatchment A6: SUB-A4

Runoff = 0.14 cfs @ 12.38 hrs, Volume= 1,146 cf, Depth= 0.31"

Runoff by SCS TR-20 method, UH=SCS, Weighted-CN, Time Span= 1.00-36.00 hrs, dt= 0.01 hrs  
Type III 24-hr 2-year Rainfall=3.10"

	Area (sf)	CN	Description
*	3,625	98	Paved Impervious, HSG A
*	8,132	98	Paved Impervious, HSG B
	13,635	30	Woods, Good, HSG A
	13,102	55	Woods, Good, HSG B
	2,357	39	>75% Grass cover, Good, HSG A
	3,960	61	>75% Grass cover, Good, HSG B
	44,811	58	Weighted Average
	33,054		73.76% Pervious Area
	11,757		26.24% Impervious Area

Tc (min)	Length (feet)	Slope (ft/ft)	Velocity (ft/sec)	Capacity (cfs)	Description
7.8	50	0.0600	0.11		<b>Sheet Flow,</b> Woods: Light underbrush n= 0.400 P2= 3.30"
2.5	120	0.0250	0.79		<b>Shallow Concentrated Flow,</b> Woodland Kv= 5.0 fps
2.4	293	0.0100	2.03		<b>Shallow Concentrated Flow,</b> Paved Kv= 20.3 fps
12.7	463	Total			

**Subcatchment A6: SUB-A4**

Hydrograph

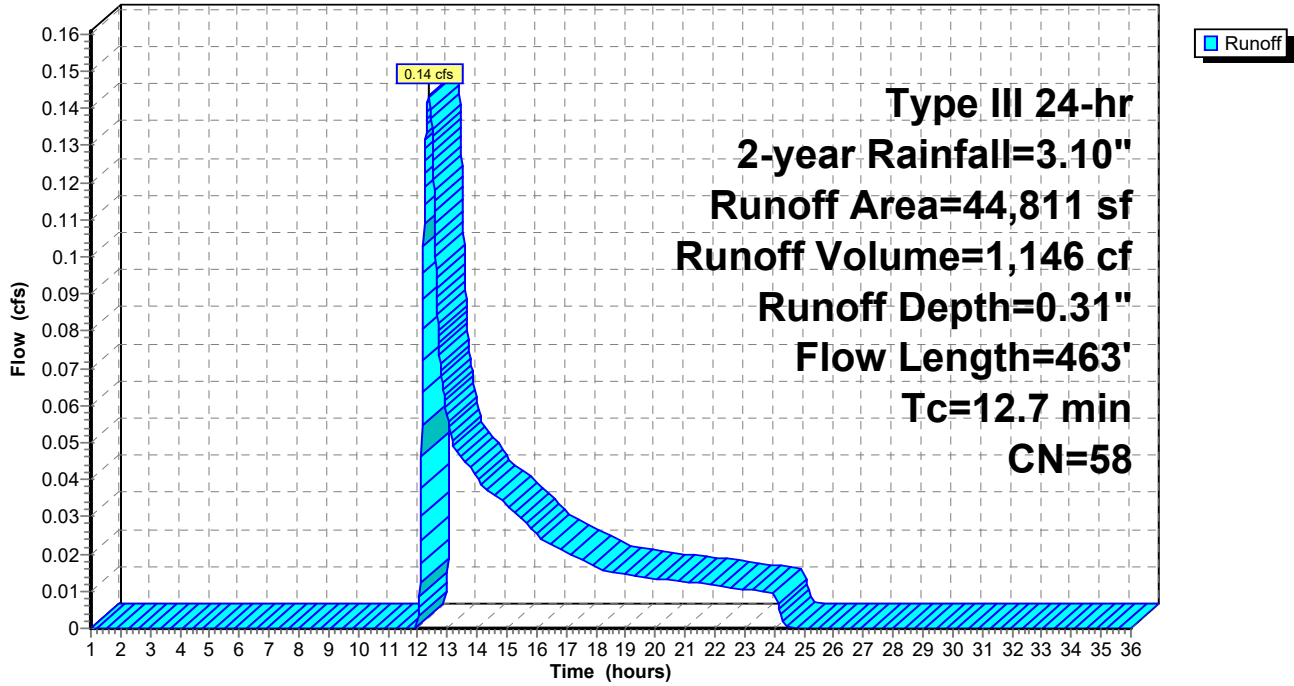

**Cole Post-Development**

Prepared by Weston & Sampson

HydroCAD® 10.10-5a s/n 00455 © 2020 HydroCAD Software Solutions LLC

Type III 24-hr 2-year Rainfall=3.10"

Printed 7/12/2021

Page 16

**Summary for Subcatchment A7: SUB-A7**

Runoff = 0.16 cfs @ 12.13 hrs, Volume= 958 cf, Depth= 0.37"

Runoff by SCS TR-20 method, UH=SCS, Weighted-CN, Time Span= 1.00-36.00 hrs, dt= 0.01 hrs  
Type III 24-hr 2-year Rainfall=3.10"

	Area (sf)	CN	Description
*	3,420	98	Paved Impervious, HSG B
	523	39	>75% Grass cover, Good, HSG A
	16,801	61	>75% Grass cover, Good, HSG B
	3,334	30	Woods, Good, HSG A
	6,999	55	Woods, Good, HSG B
	31,077	60	Weighted Average
	27,657		89.00% Pervious Area
	3,420		11.00% Impervious Area

Tc (min)	Length (feet)	Slope (ft/ft)	Velocity (ft/sec)	Capacity (cfs)	Description
6.0					Direct Entry,

**Subcatchment A7: SUB-A7**

Hydrograph

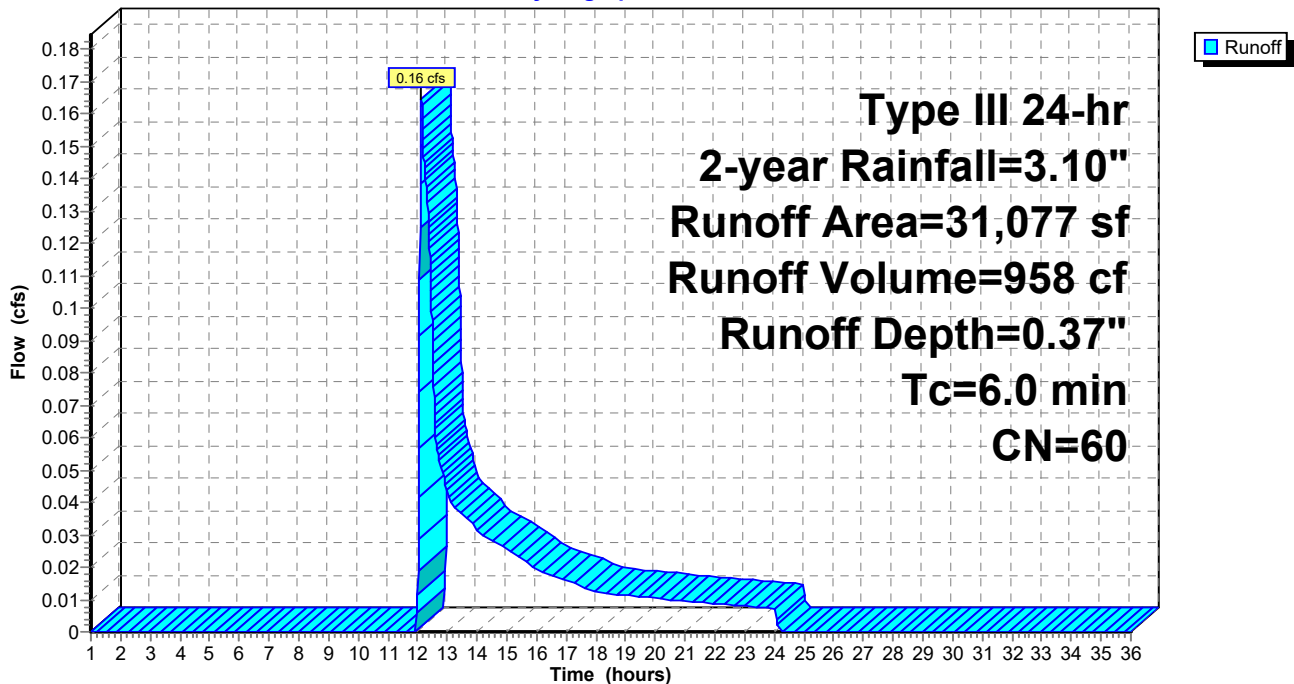

**Cole Post-Development**

Prepared by Weston & Sampson

HydroCAD® 10.10-5a s/n 00455 © 2020 HydroCAD Software Solutions LLC

Type III 24-hr 2-year Rainfall=3.10"

Printed 7/12/2021

Page 17

**Summary for Subcatchment A8: SUB-A8**

Runoff = 0.66 cfs @ 12.12 hrs, Volume= 2,569 cf, Depth= 0.68"

Runoff by SCS TR-20 method, UH=SCS, Weighted-CN, Time Span= 1.00-36.00 hrs, dt= 0.01 hrs  
Type III 24-hr 2-year Rainfall=3.10"

Area (sf)	CN	Description
* 9,176	98	Paved Impervious, HSG A
* 1,528	98	Paved Impervious, HSG B
3,894	98	Roofs, HSG A
8,917	98	Roofs, HSG B
12,216	39	>75% Grass cover, Good, HSG A
9,682	30	Woods, Good, HSG A
45,413	68	Weighted Average
21,898		48.22% Pervious Area
23,515		51.78% Impervious Area

Tc (min)	Length (feet)	Slope (ft/ft)	Velocity (ft/sec)	Capacity (cfs)	Description
6.4	50	0.1000	0.13		<b>Sheet Flow,</b> Woods: Light underbrush n= 0.400 P2= 3.30"
0.7	52	0.0570	1.19		<b>Shallow Concentrated Flow,</b> Woodland Kv= 5.0 fps
0.3	34	0.0580	1.69		<b>Shallow Concentrated Flow,</b> Short Grass Pasture Kv= 7.0 fps
7.4	136	Total			

**Cole Post-Development**

Prepared by Weston & Sampson

HydroCAD® 10.10-5a s/n 00455 © 2020 HydroCAD Software Solutions LLC

Type III 24-hr 2-year Rainfall=3.10"

Printed 7/12/2021

Page 18

**Subcatchment A8: SUB-A8**

Hydrograph

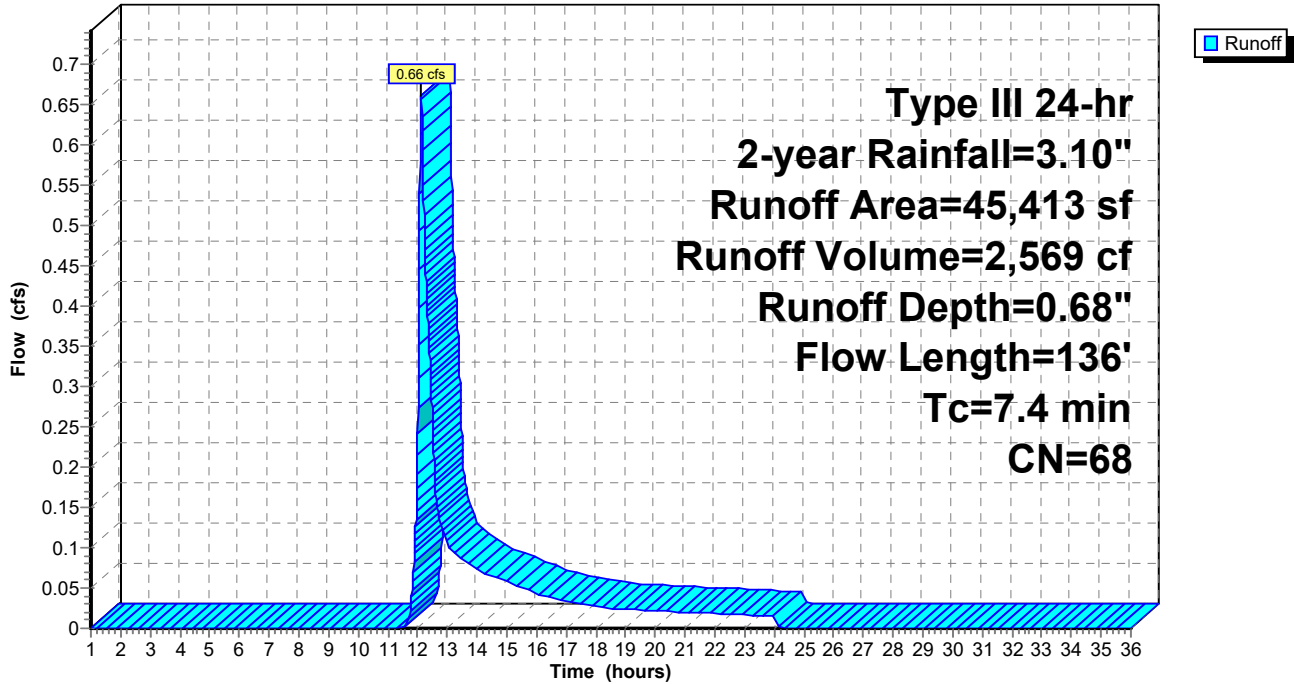

# Cole Post-Development

Prepared by Weston & Sampson

HydroCAD® 10.10-5a s/n 00455 © 2020 HydroCAD Software Solutions LLC

Type III 24-hr 2-year Rainfall=3.10"

Printed 7/12/2021

Page 19

## Summary for Subcatchment B1: SUB-B1

Runoff = 0.03 cfs @ 12.13 hrs, Volume= 182 cf, Depth= 0.37"

Runoff by SCS TR-20 method, UH=SCS, Weighted-CN, Time Span= 1.00-36.00 hrs, dt= 0.01 hrs  
Type III 24-hr 2-year Rainfall=3.10"

Area (sf)	CN	Description
5,112	61	>75% Grass cover, Good, HSG B
795	55	Woods, Good, HSG B
5,907	60	Weighted Average
5,907		100.00% Pervious Area

Tc (min)	Length (feet)	Slope (ft/ft)	Velocity (ft/sec)	Capacity (cfs)	Description
6.0					Direct Entry,

## Subcatchment B1: SUB-B1

Hydrograph

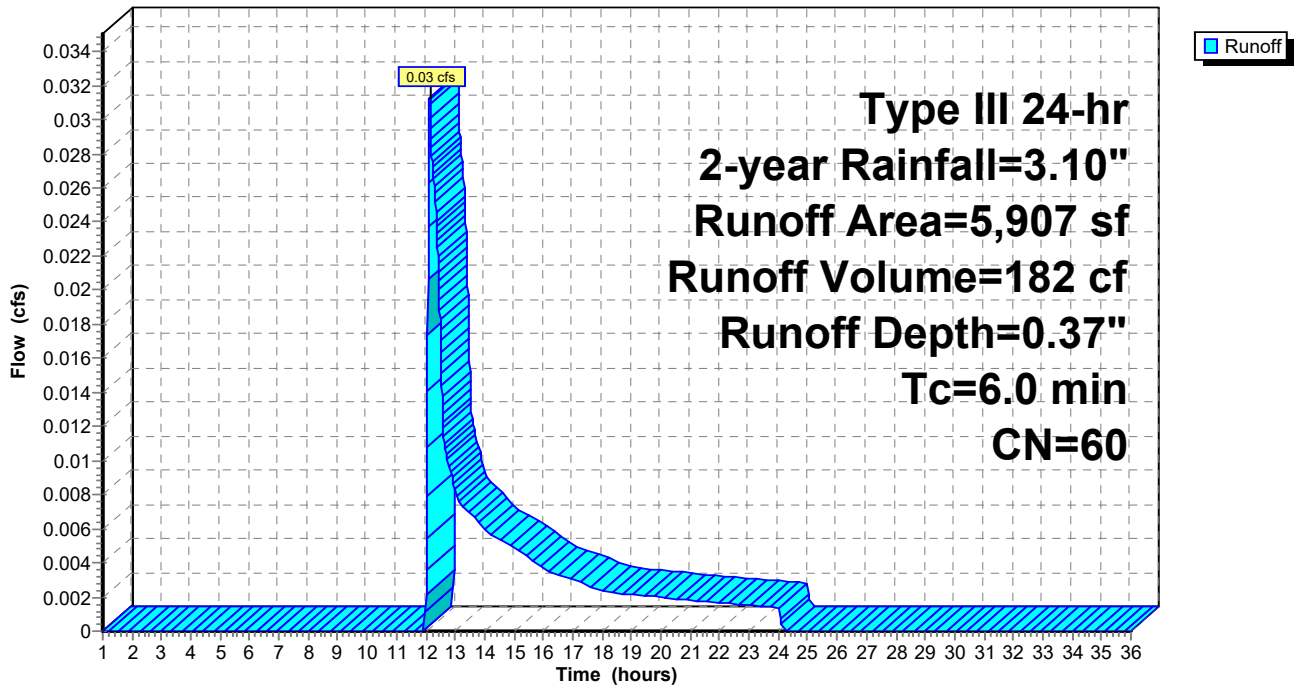

# Cole Post-Development

Prepared by Weston & Sampson

HydroCAD® 10.10-5a s/n 00455 © 2020 HydroCAD Software Solutions LLC

Type III 24-hr 2-year Rainfall=3.10"

Printed 7/12/2021

Page 20

## Summary for Pond A: POI-A

Inflow Area = 296,839 sf, 54.99% Impervious, Inflow Depth = 0.74" for 2-year event  
Inflow = 4.30 cfs @ 12.10 hrs, Volume= 18,335 cf  
Primary = 4.30 cfs @ 12.10 hrs, Volume= 18,335 cf, Atten= 0%, Lag= 0.0 min

Routing by Dyn-Stor-Ind method, Time Span= 1.00-36.00 hrs, dt= 0.01 hrs

### Pond A: POI-A

Hydrograph

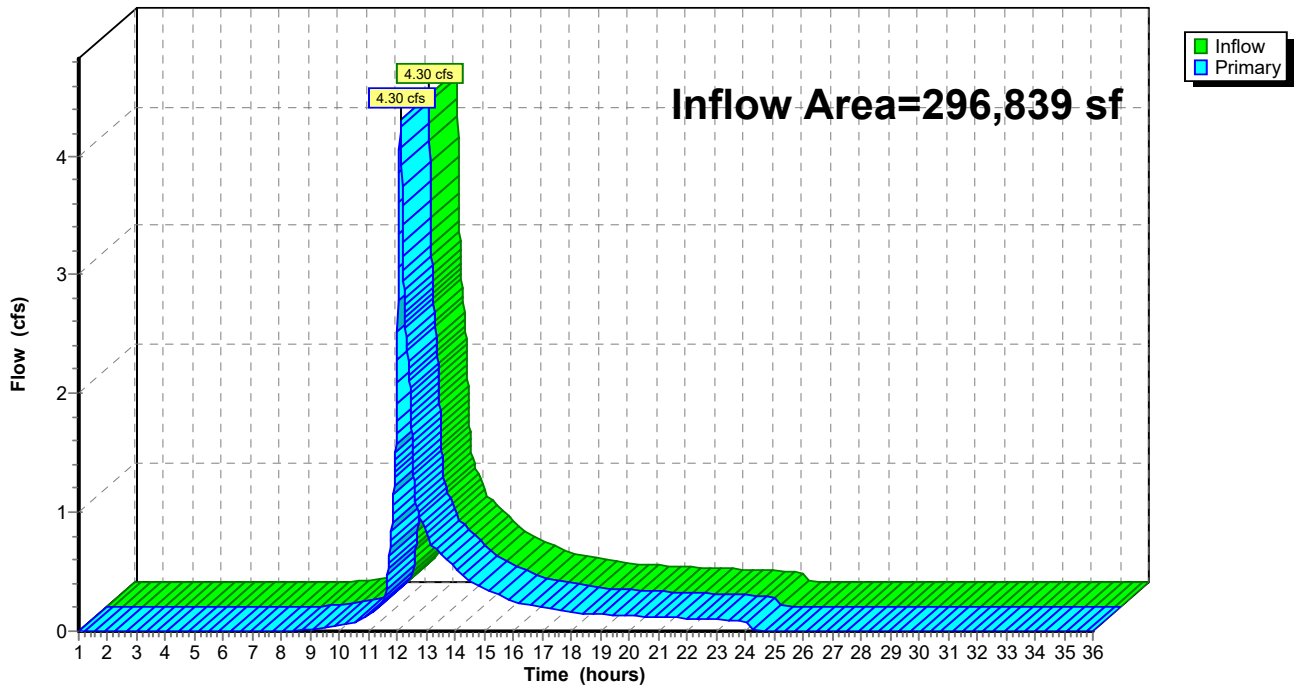



# Cole Post-Development

Prepared by Weston & Sampson

HydroCAD® 10.10-5a s/n 00455 © 2020 HydroCAD Software Solutions LLC

Type III 24-hr 2-year Rainfall=3.10"

Printed 7/12/2021

Page 21

## Summary for Pond B: POI-B

Inflow Area = 5,907 sf, 0.00% Impervious, Inflow Depth = 0.37" for 2-year event  
Inflow = 0.03 cfs @ 12.13 hrs, Volume= 182 cf  
Primary = 0.03 cfs @ 12.13 hrs, Volume= 182 cf, Atten= 0%, Lag= 0.0 min

Routing by Dyn-Stor-Ind method, Time Span= 1.00-36.00 hrs, dt= 0.01 hrs

### Pond B: POI-B

Hydrograph

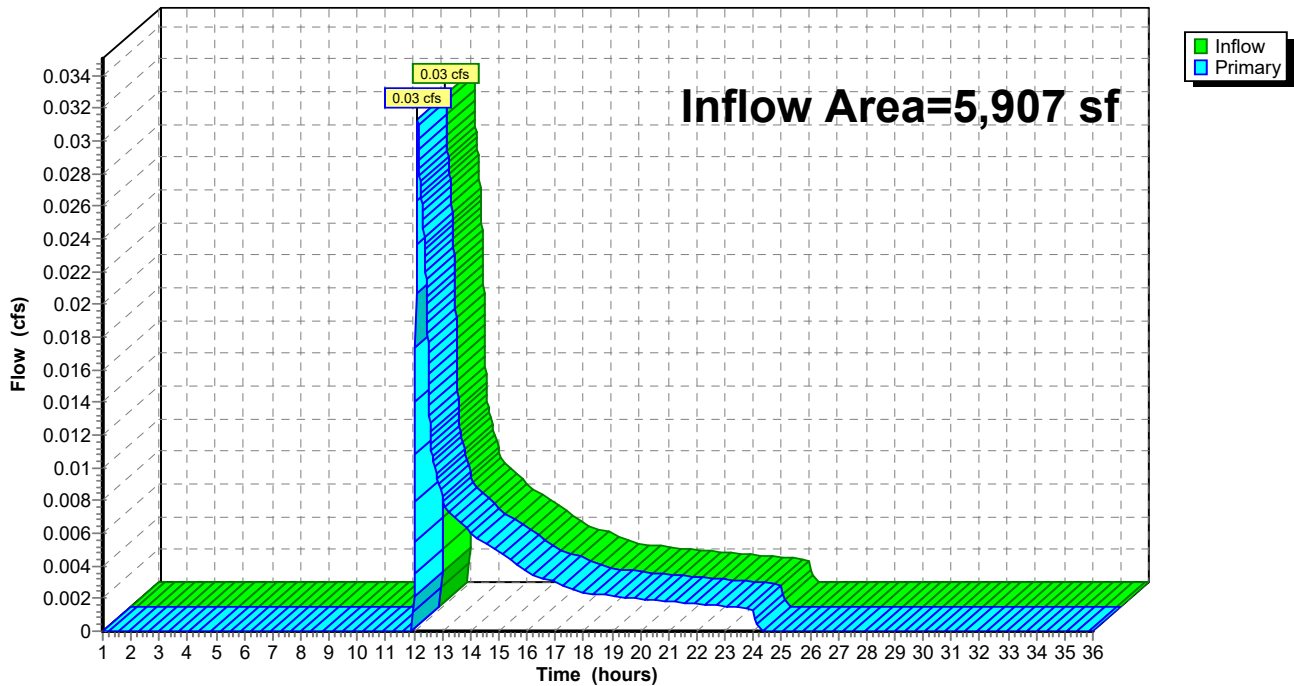

**Cole Post-Development**

Prepared by Weston & Sampson

HydroCAD® 10.10-5a s/n 00455 © 2020 HydroCAD Software Solutions LLC

Type III 24-hr 2-year Rainfall=3.10"

Printed 7/12/2021

Page 22

**Summary for Pond BR-1: BR-1**

Inflow Area = 16,500 sf, 77.45% Impervious, Inflow Depth = 1.75" for 2-year event  
 Inflow = 0.78 cfs @ 12.09 hrs, Volume= 2,404 cf  
 Outflow = 0.63 cfs @ 12.15 hrs, Volume= 1,594 cf, Atten= 19%, Lag= 3.7 min  
 Primary = 0.63 cfs @ 12.15 hrs, Volume= 1,594 cf  
 Secondary = 0.00 cfs @ 1.00 hrs, Volume= 0 cf

Routing by Dyn-Stor-Ind method, Time Span= 1.00-36.00 hrs, dt= 0.01 hrs  
 Peak Elev= 100.85' @ 12.15 hrs Surf.Area= 260 sf Storage= 833 cf

Plug-Flow detention time= 167.3 min calculated for 1,594 cf (66% of inflow)  
 Center-of-Mass det. time= 66.2 min ( 890.1 - 823.9 )

Volume	Invert	Avail.Storage	Storage Description	
#1	96.74'	1,245 cf	<b>Custom Stage Data (Prismatic)</b> Listed below (Recalc)	
Elevation (feet)	Surf.Area (sq-ft)	Voids (%)	Inc.Store (cubic-feet)	Cum.Store (cubic-feet)
96.74	641	0.0	0	0
96.75	641	40.0	3	3
97.24	641	40.0	126	128
97.25	641	30.0	2	130
100.24	641	30.0	575	705
100.25	641	40.0	3	708
100.49	641	40.0	62	769
100.50	88	100.0	4	773
101.00	335	100.0	106	879
101.75	641	100.0	366	1,245

Device	Routing	Invert	Outlet Devices
#1	Device 2	100.75'	<b>24.0" Horiz. Orifice/Grate</b> C= 0.600 Limited to weir flow at low heads
#2	Primary	94.49'	<b>12.0" Round Culvert</b> L= 62.8' CPP, projecting, no headwall, Ke= 0.900 Inlet / Outlet Invert= 94.49' / 94.18' S= 0.0049 '/' Cc= 0.900 n= 0.130, Flow Area= 0.79 sf
#3	Secondary	101.25'	<b>15.0' long x 10.0' breadth Broad-Crested Rectangular Weir</b> Head (feet) 0.20 0.40 0.60 0.80 1.00 1.20 1.40 1.60 Coef. (English) 2.49 2.56 2.70 2.69 2.68 2.69 2.67 2.64

**Primary OutFlow** Max=0.62 cfs @ 12.15 hrs HW=100.85' TW=93.57' (Dynamic Tailwater)

↑ **2=Culvert** (Passes 0.62 cfs of 1.06 cfs potential flow)  
 ↑ **1=Orifice/Grate** (Weir Controls 0.62 cfs @ 1.02 fps)

**Secondary OutFlow** Max=0.00 cfs @ 1.00 hrs HW=96.74' TW=92.50' (Dynamic Tailwater)

↑ **3=Broad-Crested Rectangular Weir** ( Controls 0.00 cfs)

# Cole Post-Development

Prepared by Weston & Sampson

HydroCAD® 10.10-5a s/n 00455 © 2020 HydroCAD Software Solutions LLC

Type III 24-hr 2-year Rainfall=3.10"

Printed 7/12/2021

Page 23

## Pond BR-1: BR-1

Hydrograph

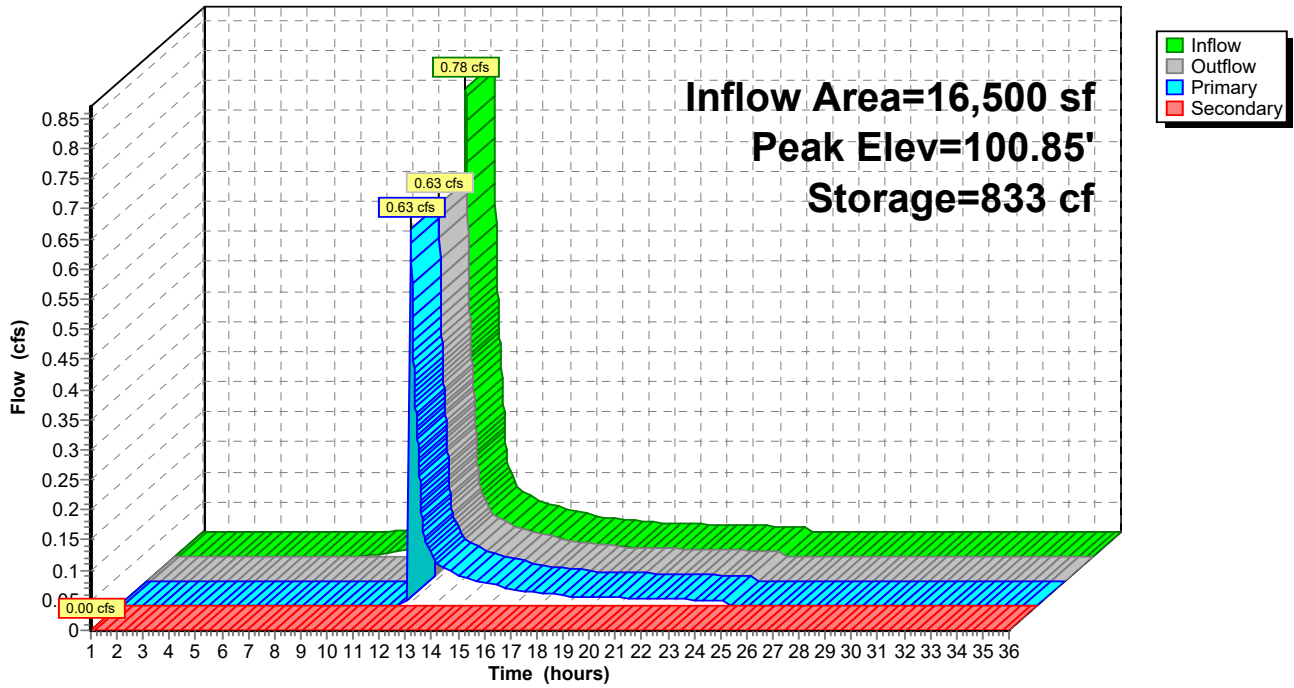

# Cole Post-Development

Prepared by Weston & Sampson

HydroCAD® 10.10-5a s/n 00455 © 2020 HydroCAD Software Solutions LLC

Type III 24-hr 2-year Rainfall=3.10"

Printed 7/12/2021

Page 24

## Summary for Pond DS-1: DS-1

Inflow Area = 35,193 sf, 61.85% Impervious, Inflow Depth = 1.14" for 2-year event  
 Inflow = 0.95 cfs @ 12.13 hrs, Volume= 3,346 cf  
 Outflow = 0.46 cfs @ 12.39 hrs, Volume= 3,345 cf, Atten= 51%, Lag= 15.4 min  
 Primary = 0.46 cfs @ 12.39 hrs, Volume= 3,345 cf

Routing by Dyn-Stor-Ind method, Time Span= 1.00-36.00 hrs, dt= 0.01 hrs  
 Peak Elev= 90.00' @ 12.39 hrs Surf.Area= 658 sf Storage= 753 cf

Plug-Flow detention time= 25.2 min calculated for 3,344 cf (100% of inflow)  
 Center-of-Mass det. time= 25.2 min ( 882.1 - 856.9 )

Volume	Invert	Avail.Storage	Storage Description
#1A	88.25'	627 cf	<b>20.50'W x 32.10'L x 3.50'H Field A</b> 2,303 cf Overall - 735 cf Embedded = 1,568 cf x 40.0% Voids
#2A	88.75'	735 cf	<b>ADS_StormTech SC-740 +Cap</b> x 16 Inside #1 Effective Size= 44.6"W x 30.0"H => 6.45 sf x 7.12'L = 45.9 cf Overall Size= 51.0"W x 30.0"H x 7.56'L with 0.44' Overlap 16 Chambers in 4 Rows
		1,362 cf	Total Available Storage

Storage Group A created with Chamber Wizard

Device	Routing	Invert	Outlet Devices
#1	Primary	88.25'	<b>24.0" Round Culvert</b> L= 26.9' CPP, projecting, no headwall, Ke= 0.900 Inlet / Outlet Invert= 88.25' / 88.12' S= 0.0048 '/' Cc= 0.900 n= 0.013 Corrugated PE, smooth interior, Flow Area= 3.14 sf
#2	Device 1	89.95'	<b>4.0' long Sharp-Crested Rectangular Weir</b> 2 End Contraction(s)
#3	Device 1	88.25'	<b>3.0" Vert. Orifice/Grate</b> C= 0.600 Limited to weir flow at low heads

**Primary OutFlow** Max=0.46 cfs @ 12.39 hrs HW=90.00' TW=0.00' (Dynamic Tailwater)

- ↑ **1=Culvert** (Passes 0.46 cfs of 8.99 cfs potential flow)
- ↑ **2=Sharp-Crested Rectangular Weir** (Weir Controls 0.16 cfs @ 0.76 fps)
- ↑ **3=Orifice/Grate** (Orifice Controls 0.30 cfs @ 6.14 fps)

**Cole Post-Development**

Prepared by Weston & Sampson

HydroCAD® 10.10-5a s/n 00455 © 2020 HydroCAD Software Solutions LLC

Type III 24-hr 2-year Rainfall=3.10"

Printed 7/12/2021

Page 25

**Pond DS-1: DS-1 - Chamber Wizard Field A**

**Chamber Model = ADS\_StormTechSC-740 +Cap (ADS StormTech®SC-740 with cap length)**

Effective Size= 44.6"W x 30.0"H => 6.45 sf x 7.12'L = 45.9 cf

Overall Size= 51.0"W x 30.0"H x 7.56'L with 0.44' Overlap

51.0" Wide + 6.0" Spacing = 57.0" C-C Row Spacing

4 Chambers/Row x 7.12' Long +0.81' Cap Length x 2 = 30.10' Row Length +12.0" End Stone x 2 = 32.10' Base Length

4 Rows x 51.0" Wide + 6.0" Spacing x 3 + 12.0" Side Stone x 2 = 20.50' Base Width

6.0" Stone Base + 30.0" Chamber Height + 6.0" Stone Cover = 3.50' Field Height

16 Chambers x 45.9 cf = 735.0 cf Chamber Storage

2,302.9 cf Field - 735.0 cf Chambers = 1,567.9 cf Stone x 40.0% Voids = 627.2 cf Stone Storage

Chamber Storage + Stone Storage = 1,362.2 cf = 0.031 af

Overall Storage Efficiency = 59.2%

Overall System Size = 32.10' x 20.50' x 3.50'

16 Chambers

85.3 cy Field

58.1 cy Stone

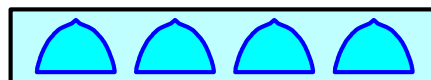
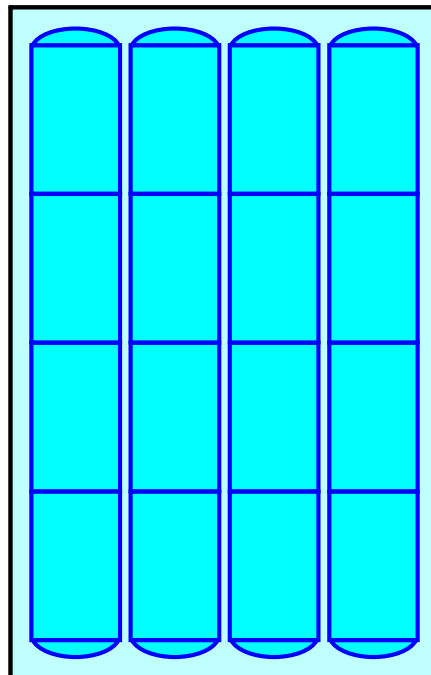

**Cole Post-Development**

Prepared by Weston & Sampson

HydroCAD® 10.10-5a s/n 00455 © 2020 HydroCAD Software Solutions LLC

Type III 24-hr 2-year Rainfall=3.10"

Printed 7/12/2021

Page 26

**Pond DS-1: DS-1**

Hydrograph

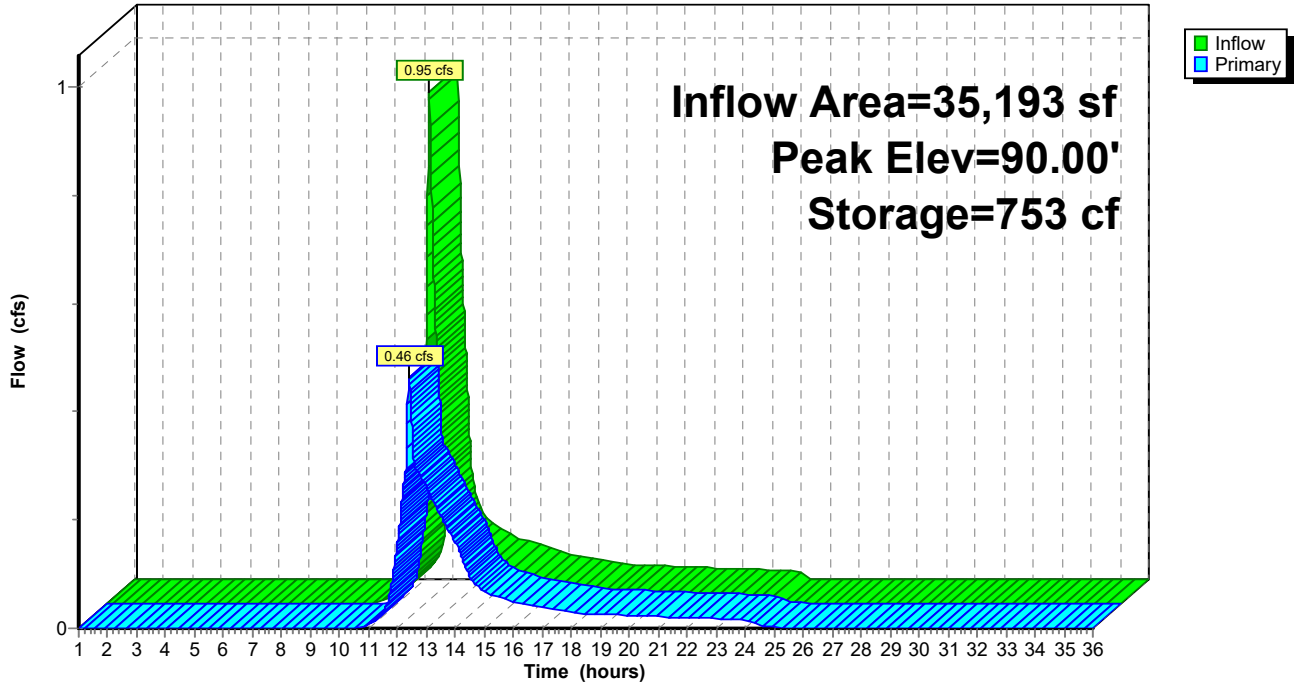

# Cole Post-Development

Prepared by Weston & Sampson

HydroCAD® 10.10-5a s/n 00455 © 2020 HydroCAD Software Solutions LLC

Type III 24-hr 2-year Rainfall=3.10"

Printed 7/12/2021

Page 27

## Summary for Pond IS-1: IS-1

Inflow Area = 61,597 sf, 85.38% Impervious, Inflow Depth = 1.96" for 2-year event  
 Inflow = 2.80 cfs @ 12.14 hrs, Volume= 10,071 cf  
 Outflow = 0.23 cfs @ 13.67 hrs, Volume= 10,071 cf, Atten= 92%, Lag= 91.7 min  
 Discarded = 0.23 cfs @ 13.67 hrs, Volume= 10,059 cf  
 Primary = 0.00 cfs @ 13.67 hrs, Volume= 13 cf

Routing by Dyn-Stor-Ind method, Time Span= 1.00-36.00 hrs, dt= 0.01 hrs  
 Peak Elev= 94.24' @ 13.67 hrs Surf.Area= 3,603 sf Storage= 4,071 cf

Plug-Flow detention time= 159.1 min calculated for 10,071 cf (100% of inflow)  
 Center-of-Mass det. time= 159.1 min ( 972.5 - 813.3 )

Volume	Invert	Avail.Storage	Storage Description
#1A	92.50'	5,063 cf	<b>29.92'W x 120.42'L x 5.50'H Field A</b> 19,814 cf Overall - 7,156 cf Embedded = 12,658 cf x 40.0% Voids
#2A	93.25'	7,156 cf	<b>ADS_StormTech MC-3500 d +Cap</b> x 64 Inside #1 Effective Size= 70.4"W x 45.0"H => 15.33 sf x 7.17'L = 110.0 cf Overall Size= 77.0"W x 45.0"H x 7.50'L with 0.33' Overlap 64 Chambers in 4 Rows Cap Storage= +14.9 cf x 2 x 4 rows = 119.2 cf
		12,219 cf	Total Available Storage

Storage Group A created with Chamber Wizard

Device	Routing	Invert	Outlet Devices
#1	Discarded	92.50'	<b>2.410 in/hr Exfiltration over Wetted area</b> Phase-In= 0.01'
#2	Primary	92.00'	<b>12.0" Round Culvert</b> L= 91.3' CPP, projecting, no headwall, Ke= 0.900 Inlet / Outlet Invert= 92.00' / 91.09' S= 0.0100 '/' Cc= 0.900 n= 0.013 Corrugated PE, smooth interior, Flow Area= 0.79 sf
#3	Device 2	97.00'	<b>4.0' long Sharp-Crested Rectangular Weir</b> 2 End Contraction(s)
#4	Device 2	94.20'	<b>4.0" Vert. Orifice/Grate</b> C= 0.600 Limited to weir flow at low heads

**Discarded OutFlow** Max=0.23 cfs @ 13.67 hrs HW=94.24' (Free Discharge)

↑ **1=Exfiltration** (Exfiltration Controls 0.23 cfs)

**Primary OutFlow** Max=0.00 cfs @ 13.67 hrs HW=94.24' TW=0.00' (Dynamic Tailwater)

↑ **2=Culvert** (Passes 0.00 cfs of 3.94 cfs potential flow)

↑ **3=Sharp-Crested Rectangular Weir** ( Controls 0.00 cfs)

↑ **4=Orifice/Grate** (Orifice Controls 0.00 cfs @ 0.67 fps)

# Cole Post-Development

Prepared by Weston & Sampson

HydroCAD® 10.10-5a s/n 00455 © 2020 HydroCAD Software Solutions LLC

Type III 24-hr 2-year Rainfall=3.10"

Printed 7/12/2021

Page 28

## Pond IS-1: IS-1 - Chamber Wizard Field A

**Chamber Model = ADS\_StormTechMC-3500 d +Cap (ADS StormTech®MC-3500 d rev 03/14 with Cap volume)**

Effective Size= 70.4"W x 45.0"H => 15.33 sf x 7.17'L = 110.0 cf

Overall Size= 77.0"W x 45.0"H x 7.50'L with 0.33' Overlap

Cap Storage= +14.9 cf x 2 x 4 rows = 119.2 cf

77.0" Wide + 9.0" Spacing = 86.0" C-C Row Spacing

16 Chambers/Row x 7.17' Long +1.85' Cap Length x 2 = 118.42' Row Length +12.0" End Stone x 2 = 120.42' Base Length

4 Rows x 77.0" Wide + 9.0" Spacing x 3 + 12.0" Side Stone x 2 = 29.92' Base Width

9.0" Stone Base + 45.0" Chamber Height + 12.0" Stone Cover = 5.50' Field Height

64 Chambers x 110.0 cf + 14.9 cf Cap Volume x 2 x 4 Rows = 7,156.1 cf Chamber Storage

19,814.1 cf Field - 7,156.1 cf Chambers = 12,658.0 cf Stone x 40.0% Voids = 5,063.2 cf Stone Storage

Chamber Storage + Stone Storage = 12,219.3 cf = 0.281 af

Overall Storage Efficiency = 61.7%

Overall System Size = 120.42' x 29.92' x 5.50'

64 Chambers

733.9 cy Field

468.8 cy Stone

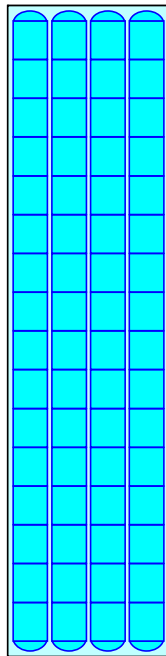



# Cole Post-Development

Prepared by Weston & Sampson

HydroCAD® 10.10-5a s/n 00455 © 2020 HydroCAD Software Solutions LLC

Type III 24-hr 2-year Rainfall=3.10"

Printed 7/12/2021

Page 29

## Pond IS-1: IS-1

Hydrograph

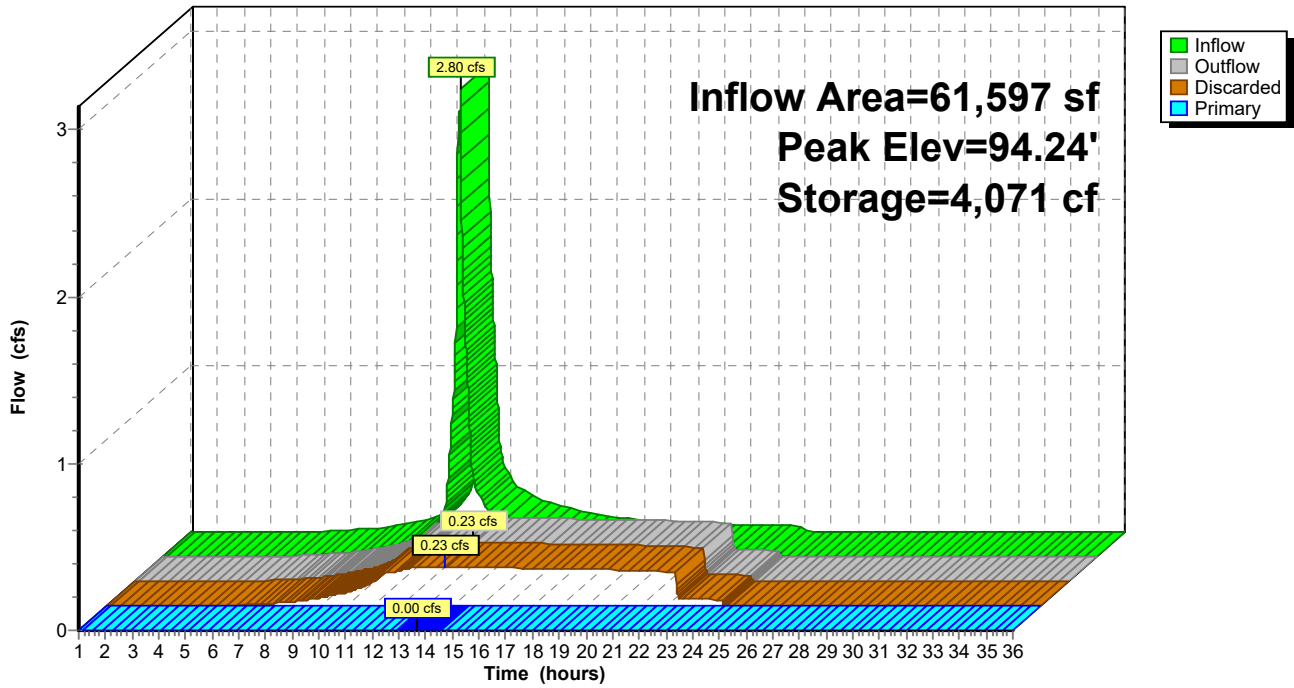

**Cole Post-Development**

Prepared by Weston &amp; Sampson

HydroCAD® 10.10-5a s/n 00455 © 2020 HydroCAD Software Solutions LLC

Type III 24-hr 10-year Rainfall=4.70"

Printed 7/12/2021

Page 30

Time span=1.00-36.00 hrs, dt=0.01 hrs, 3501 points  
 Runoff by SCS TR-20 method, UH=SCS, Weighted-CN  
 Reach routing by Dyn-Stor-Ind method - Pond routing by Dyn-Stor-Ind method

<b>SubcatchmentA1: SUB-A1</b>	Runoff Area=67,238 sf 64.49% Impervious Runoff Depth=3.09" Tc=6.0 min CN=85 Runoff=5.55 cfs 17,324 cf
<b>SubcatchmentA2: SUB-A2</b>	Runoff Area=35,193 sf 61.85% Impervious Runoff Depth=2.37" Flow Length=160' Tc=8.9 min CN=77 Runoff=2.03 cfs 6,963 cf
<b>SubcatchmentA3: SUB-A3</b>	Runoff Area=16,500 sf 77.45% Impervious Runoff Depth=3.19" Tc=6.0 min CN=86 Runoff=1.40 cfs 4,384 cf
<b>SubcatchmentA4: SUB-A4</b>	Runoff Area=45,097 sf 88.28% Impervious Runoff Depth=3.80" Tc=6.0 min CN=92 Runoff=4.39 cfs 14,268 cf
<b>SubcatchmentA5: SUB-A2</b>	Runoff Area=11,510 sf 59.26% Impervious Runoff Depth=2.13" Tc=6.0 min CN=74 Runoff=0.65 cfs 2,041 cf
<b>SubcatchmentA6: SUB-A4</b>	Runoff Area=44,811 sf 26.24% Impervious Runoff Depth=1.01" Flow Length=463' Tc=12.7 min CN=58 Runoff=0.80 cfs 3,763 cf
<b>SubcatchmentA7: SUB-A7</b>	Runoff Area=31,077 sf 11.00% Impervious Runoff Depth=1.13" Tc=6.0 min CN=60 Runoff=0.83 cfs 2,926 cf
<b>SubcatchmentA8: SUB-A8</b>	Runoff Area=45,413 sf 51.78% Impervious Runoff Depth=1.67" Flow Length=136' Tc=7.4 min CN=68 Runoff=1.87 cfs 6,317 cf
<b>SubcatchmentB1: SUB-B1</b>	Runoff Area=5,907 sf 0.00% Impervious Runoff Depth=1.13" Tc=6.0 min CN=60 Runoff=0.16 cfs 556 cf
<b>Pond A: POI-A</b>	Inflow=11.11 cfs 43,944 cf Primary=11.11 cfs 43,944 cf
<b>Pond B: POI-B</b>	Inflow=0.16 cfs 556 cf Primary=0.16 cfs 556 cf
<b>Pond BR-1: BR-1</b>	Peak Elev=101.15' Storage=933 cf Inflow=1.40 cfs 4,384 cf Primary=1.09 cfs 3,573 cf Secondary=0.00 cfs 0 cf Outflow=1.09 cfs 3,573 cf
<b>Pond DS-1: DS-1</b>	Peak Elev=90.21' Storage=846 cf Inflow=2.03 cfs 6,963 cf Outflow=2.01 cfs 6,962 cf
<b>Pond IS-1: IS-1</b>	Peak Elev=95.40' Storage=7,350 cf Inflow=5.47 cfs 17,841 cf Discarded=0.25 cfs 13,230 cf Primary=0.43 cfs 4,612 cf Outflow=0.68 cfs 17,841 cf

**Total Runoff Area = 302,746 sf Runoff Volume = 58,541 cf Average Runoff Depth = 2.32"**  
**46.08% Pervious = 139,512 sf 53.92% Impervious = 163,234 sf**

**Cole Post-Development**

Prepared by Weston & Sampson

HydroCAD® 10.10-5a s/n 00455 © 2020 HydroCAD Software Solutions LLC

Type III 24-hr 10-year Rainfall=4.70"

Printed 7/12/2021

Page 31

**Summary for Subcatchment A1: SUB-A1**

Runoff = 5.55 cfs @ 12.09 hrs, Volume= 17,324 cf, Depth= 3.09"

Runoff by SCS TR-20 method, UH=SCS, Weighted-CN, Time Span= 1.00-36.00 hrs, dt= 0.01 hrs  
Type III 24-hr 10-year Rainfall=4.70"

	Area (sf)	CN	Description
*	27,200	98	Paved Impervious, HSG B
	16,163	98	Roofs, HSG B
	23,006	61	>75% Grass cover, Good, HSG B
	869	55	Woods, Good, HSG B
	67,238	85	Weighted Average
	23,875		35.51% Pervious Area
	43,363		64.49% Impervious Area

Tc (min)	Length (feet)	Slope (ft/ft)	Velocity (ft/sec)	Capacity (cfs)	Description
6.0					Direct Entry,

**Subcatchment A1: SUB-A1**

Hydrograph

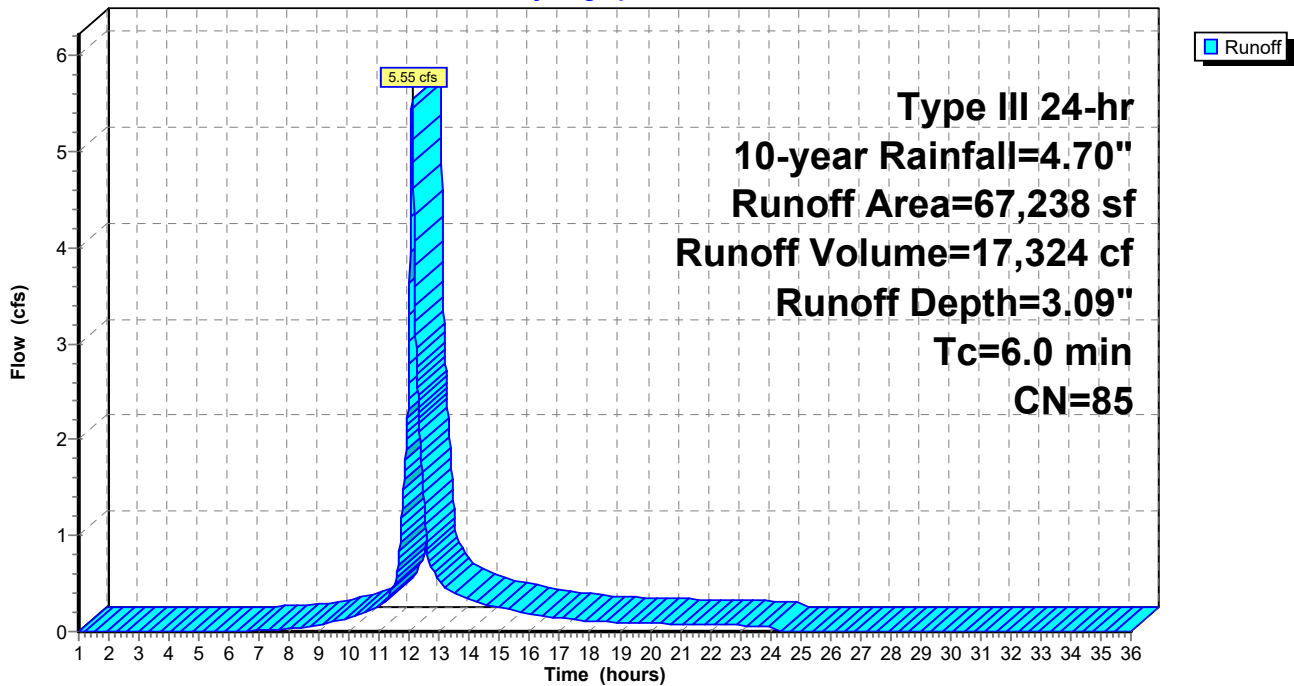

**Cole Post-Development**

Prepared by Weston & Sampson

HydroCAD® 10.10-5a s/n 00455 © 2020 HydroCAD Software Solutions LLC

Type III 24-hr 10-year Rainfall=4.70"

Printed 7/12/2021

Page 32

**Summary for Subcatchment A2: SUB-A2**

Runoff = 2.03 cfs @ 12.13 hrs, Volume= 6,963 cf, Depth= 2.37"

Runoff by SCS TR-20 method, UH=SCS, Weighted-CN, Time Span= 1.00-36.00 hrs, dt= 0.01 hrs  
Type III 24-hr 10-year Rainfall=4.70"

Area (sf)	CN	Description
* 23	98	Paved Impervious, HSG A
* 18,246	98	Paved Impervious, HSG B
3,498	98	Roofs, HSG B
1,694	39	>75% Grass cover, Good, HSG A
4,693	61	>75% Grass cover, Good, HSG B
6,952	30	Woods, Good, HSG A
87	55	Woods, Good, HSG B
35,193	77	Weighted Average
13,426		38.15% Pervious Area
21,767		61.85% Impervious Area

Tc (min)	Length (feet)	Slope (ft/ft)	Velocity (ft/sec)	Capacity (cfs)	Description
7.4	50	0.0700	0.11		<b>Sheet Flow,</b> Woods: Light underbrush n= 0.400 P2= 3.30"
0.5	33	0.0450	1.06		<b>Shallow Concentrated Flow,</b> Woodland Kv= 5.0 fps
0.9	59	0.0250	1.11		<b>Shallow Concentrated Flow,</b> Short Grass Pasture Kv= 7.0 fps
0.1	18	0.0150	2.49		<b>Shallow Concentrated Flow,</b> Paved Kv= 20.3 fps
8.9	160	Total			

**Cole Post-Development**

Prepared by Weston & Sampson

HydroCAD® 10.10-5a s/n 00455 © 2020 HydroCAD Software Solutions LLC

Type III 24-hr 10-year Rainfall=4.70"

Printed 7/12/2021

Page 33

**Subcatchment A2: SUB-A2**

Hydrograph

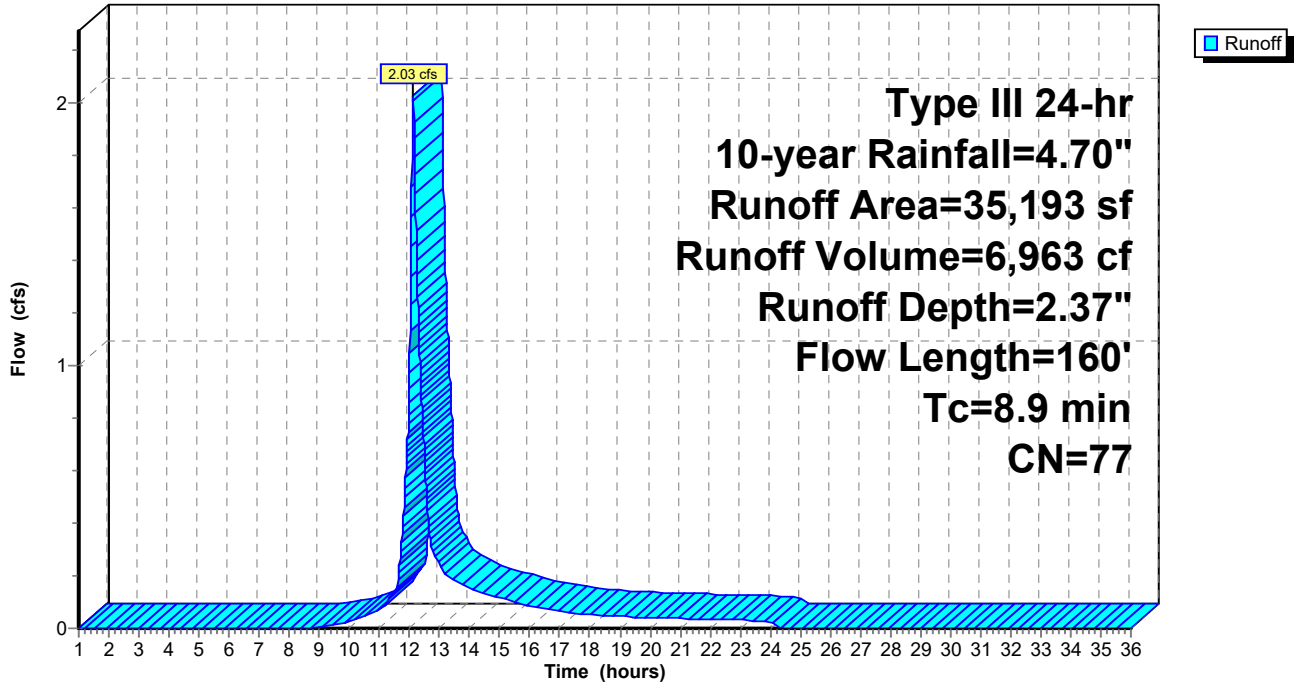

**Cole Post-Development**

Prepared by Weston & Sampson

HydroCAD® 10.10-5a s/n 00455 © 2020 HydroCAD Software Solutions LLC

Type III 24-hr 10-year Rainfall=4.70"

Printed 7/12/2021

Page 34

**Summary for Subcatchment A3: SUB-A3**

Runoff = 1.40 cfs @ 12.09 hrs, Volume= 4,384 cf, Depth= 3.19"

Runoff by SCS TR-20 method, UH=SCS, Weighted-CN, Time Span= 1.00-36.00 hrs, dt= 0.01 hrs  
Type III 24-hr 10-year Rainfall=4.70"

	Area (sf)	CN	Description
*	4,196	98	Paved Impervious, HSG A
*	1,717	98	Paved Impervious, HSG B
	6,866	98	Roofs, HSG B
	2,808	39	>75% Grass cover, Good, HSG A
	913	61	>75% Grass cover, Good, HSG B
	16,500	86	Weighted Average
	3,721		22.55% Pervious Area
	12,779		77.45% Impervious Area

Tc (min)	Length (feet)	Slope (ft/ft)	Velocity (ft/sec)	Capacity (cfs)	Description
6.0					Direct Entry,

**Subcatchment A3: SUB-A3**

Hydrograph

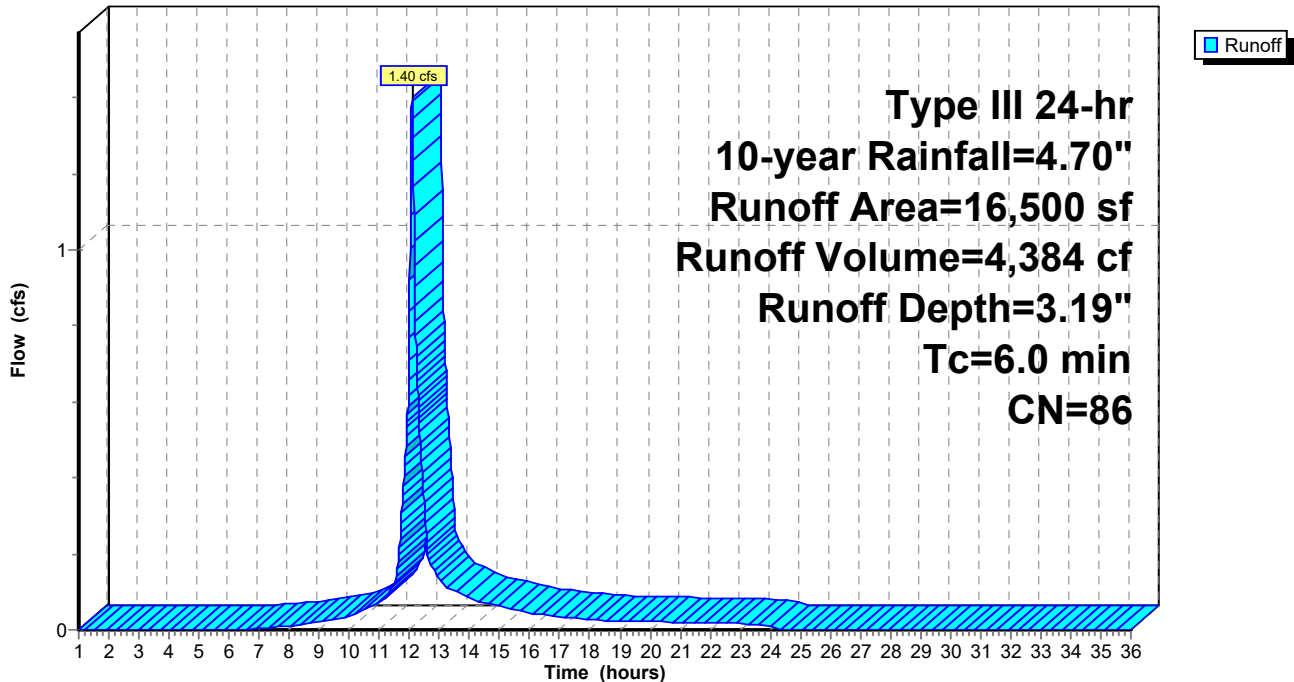

**Cole Post-Development**

Prepared by Weston & Sampson

HydroCAD® 10.10-5a s/n 00455 © 2020 HydroCAD Software Solutions LLC

Type III 24-hr 10-year Rainfall=4.70"

Printed 7/12/2021

Page 35

**Summary for Subcatchment A4: SUB-A4**

Runoff = 4.39 cfs @ 12.08 hrs, Volume= 14,268 cf, Depth= 3.80"

Runoff by SCS TR-20 method, UH=SCS, Weighted-CN, Time Span= 1.00-36.00 hrs, dt= 0.01 hrs  
Type III 24-hr 10-year Rainfall=4.70"

	Area (sf)	CN	Description
*	28,479	98	Paved Impervious, HSG A
*	4,701	98	Paved Impervious, HSG B
	3,540	98	Roofs, HSG A
	3,092	98	Roofs, HSG B
	3,675	39	>75% Grass cover, Good, HSG A
	1,610	61	>75% Grass cover, Good, HSG B
	45,097	92	Weighted Average
	5,285		11.72% Pervious Area
	39,812		88.28% Impervious Area

Tc (min)	Length (feet)	Slope (ft/ft)	Velocity (ft/sec)	Capacity (cfs)	Description
6.0					Direct Entry,

**Subcatchment A4: SUB-A4**

Hydrograph

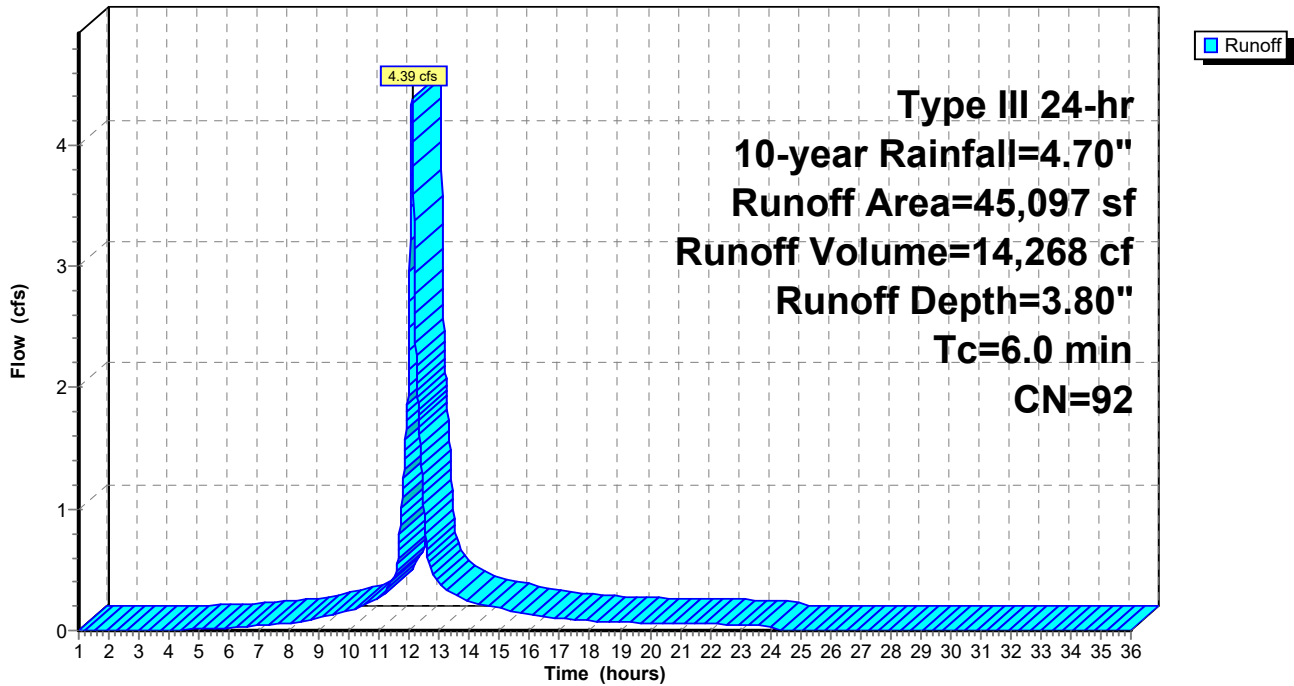

**Cole Post-Development**

Prepared by Weston & Sampson

HydroCAD® 10.10-5a s/n 00455 © 2020 HydroCAD Software Solutions LLC

Type III 24-hr 10-year Rainfall=4.70"

Printed 7/12/2021

Page 36

**Summary for Subcatchment A5: SUB-A2**

Runoff = 0.65 cfs @ 12.09 hrs, Volume= 2,041 cf, Depth= 2.13"

Runoff by SCS TR-20 method, UH=SCS, Weighted-CN, Time Span= 1.00-36.00 hrs, dt= 0.01 hrs  
Type III 24-hr 10-year Rainfall=4.70"

	Area (sf)	CN	Description
*	5,725	98	Paved Impervious, HSG A
*	1,096	98	Paved Impervious, HSG B
	4,689	39	>75% Grass cover, Good, HSG A
	11,510	74	Weighted Average
	4,689		40.74% Pervious Area
	6,821		59.26% Impervious Area

Tc (min)	Length (feet)	Slope (ft/ft)	Velocity (ft/sec)	Capacity (cfs)	Description
6.0					Direct Entry,

**Subcatchment A5: SUB-A2**

Hydrograph

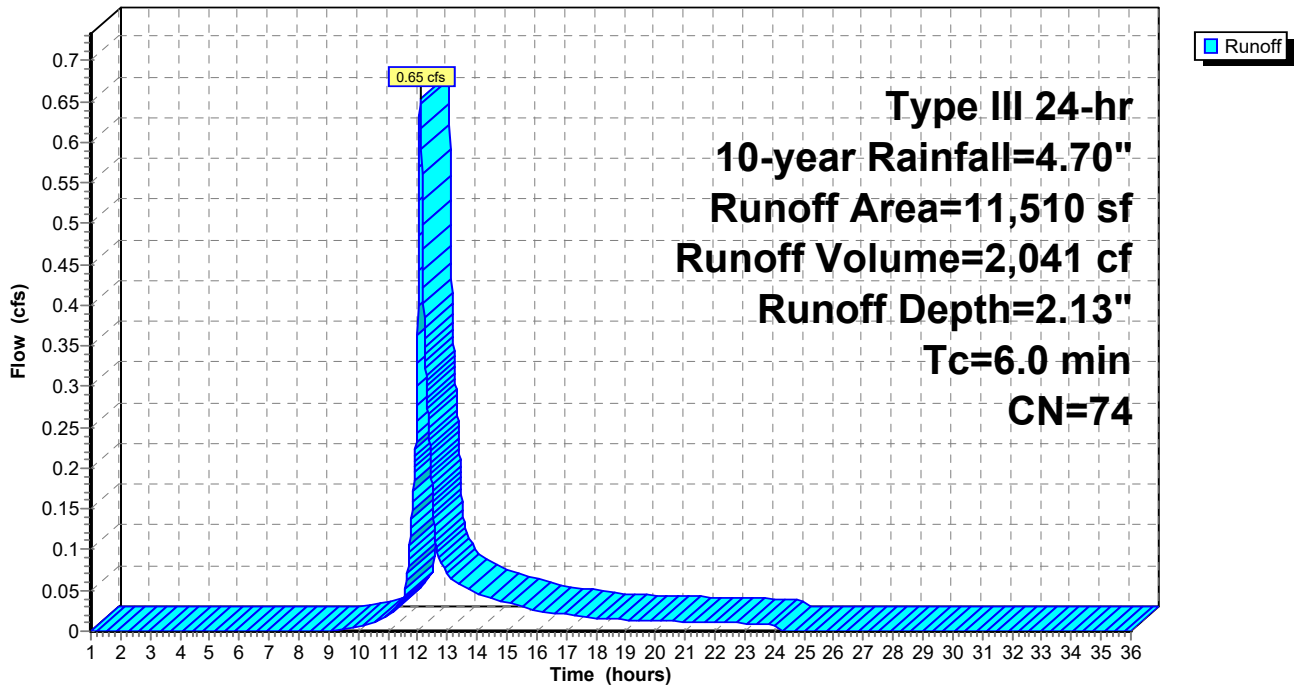



**Cole Post-Development**

Prepared by Weston & Sampson

HydroCAD® 10.10-5a s/n 00455 © 2020 HydroCAD Software Solutions LLC

Type III 24-hr 10-year Rainfall=4.70"

Printed 7/12/2021

Page 37

**Summary for Subcatchment A6: SUB-A4**

Runoff = 0.80 cfs @ 12.20 hrs, Volume= 3,763 cf, Depth= 1.01"

Runoff by SCS TR-20 method, UH=SCS, Weighted-CN, Time Span= 1.00-36.00 hrs, dt= 0.01 hrs  
Type III 24-hr 10-year Rainfall=4.70"

	Area (sf)	CN	Description
*	3,625	98	Paved Impervious, HSG A
*	8,132	98	Paved Impervious, HSG B
	13,635	30	Woods, Good, HSG A
	13,102	55	Woods, Good, HSG B
	2,357	39	>75% Grass cover, Good, HSG A
	3,960	61	>75% Grass cover, Good, HSG B
	44,811	58	Weighted Average
	33,054		73.76% Pervious Area
	11,757		26.24% Impervious Area

Tc (min)	Length (feet)	Slope (ft/ft)	Velocity (ft/sec)	Capacity (cfs)	Description
7.8	50	0.0600	0.11		<b>Sheet Flow,</b> Woods: Light underbrush n= 0.400 P2= 3.30"
2.5	120	0.0250	0.79		<b>Shallow Concentrated Flow,</b> Woodland Kv= 5.0 fps
2.4	293	0.0100	2.03		<b>Shallow Concentrated Flow,</b> Paved Kv= 20.3 fps
12.7	463	Total			

**Subcatchment A6: SUB-A4**

Hydrograph

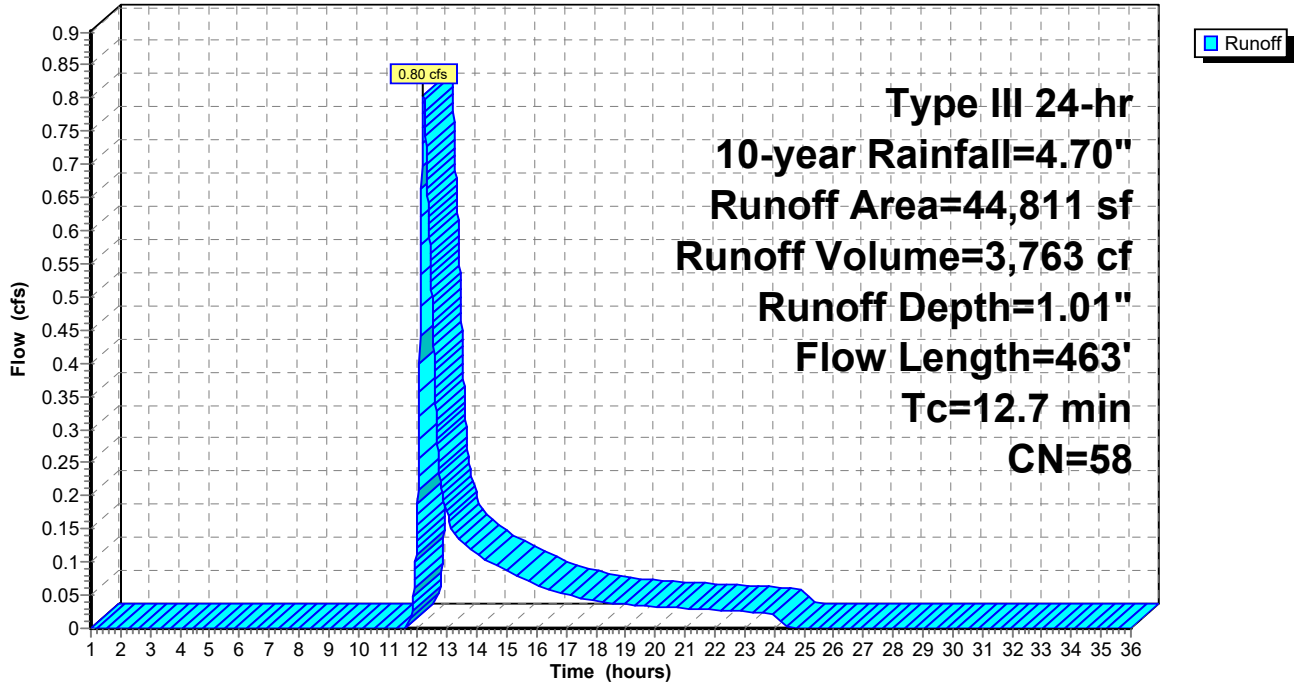

**Cole Post-Development**

Prepared by Weston & Sampson

HydroCAD® 10.10-5a s/n 00455 © 2020 HydroCAD Software Solutions LLC

Type III 24-hr 10-year Rainfall=4.70"

Printed 7/12/2021

Page 39

**Summary for Subcatchment A7: SUB-A7**

Runoff = 0.83 cfs @ 12.10 hrs, Volume= 2,926 cf, Depth= 1.13"

Runoff by SCS TR-20 method, UH=SCS, Weighted-CN, Time Span= 1.00-36.00 hrs, dt= 0.01 hrs  
Type III 24-hr 10-year Rainfall=4.70"

	Area (sf)	CN	Description
*	3,420	98	Paved Impervious, HSG B
	523	39	>75% Grass cover, Good, HSG A
	16,801	61	>75% Grass cover, Good, HSG B
	3,334	30	Woods, Good, HSG A
	6,999	55	Woods, Good, HSG B
	31,077	60	Weighted Average
	27,657		89.00% Pervious Area
	3,420		11.00% Impervious Area

Tc (min)	Length (feet)	Slope (ft/ft)	Velocity (ft/sec)	Capacity (cfs)	Description
6.0					Direct Entry,

**Subcatchment A7: SUB-A7**

Hydrograph

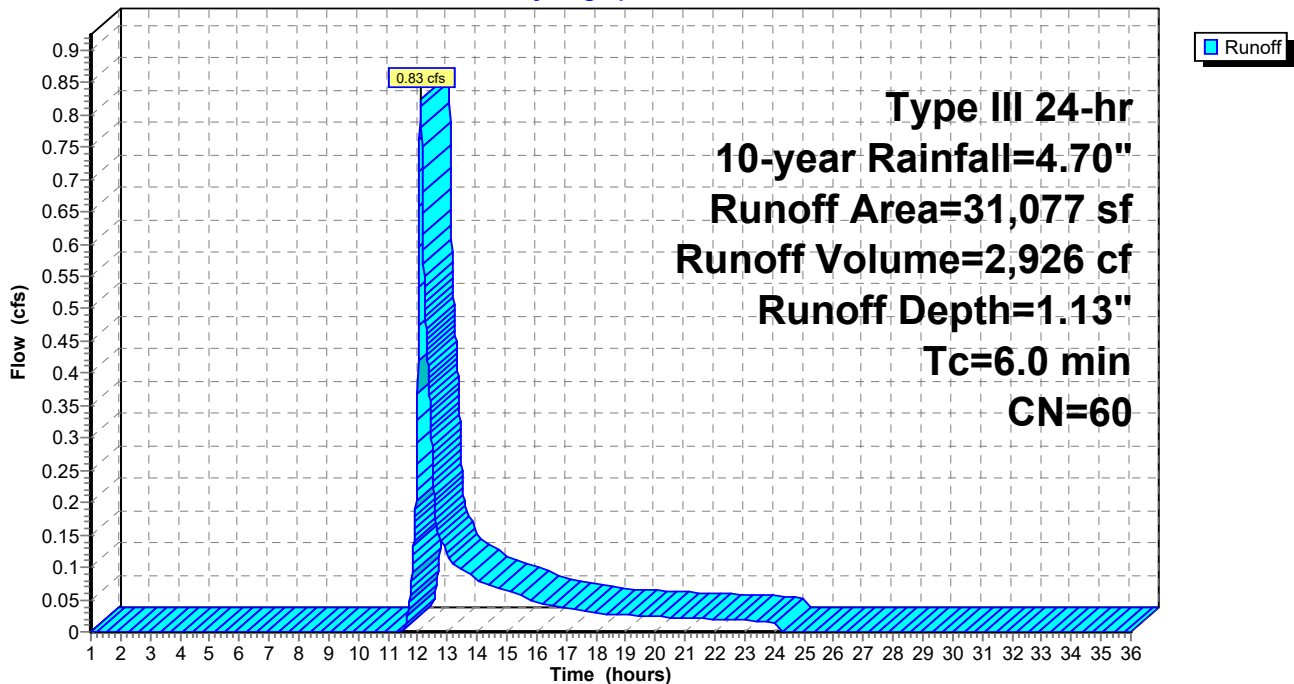

**Cole Post-Development**

Prepared by Weston & Sampson

HydroCAD® 10.10-5a s/n 00455 © 2020 HydroCAD Software Solutions LLC

Type III 24-hr 10-year Rainfall=4.70"

Printed 7/12/2021

Page 40

**Summary for Subcatchment A8: SUB-A8**

Runoff = 1.87 cfs @ 12.11 hrs, Volume= 6,317 cf, Depth= 1.67"

Runoff by SCS TR-20 method, UH=SCS, Weighted-CN, Time Span= 1.00-36.00 hrs, dt= 0.01 hrs  
Type III 24-hr 10-year Rainfall=4.70"

Area (sf)	CN	Description
* 9,176	98	Paved Impervious, HSG A
* 1,528	98	Paved Impervious, HSG B
3,894	98	Roofs, HSG A
8,917	98	Roofs, HSG B
12,216	39	>75% Grass cover, Good, HSG A
9,682	30	Woods, Good, HSG A
45,413	68	Weighted Average
21,898		48.22% Pervious Area
23,515		51.78% Impervious Area

Tc (min)	Length (feet)	Slope (ft/ft)	Velocity (ft/sec)	Capacity (cfs)	Description
6.4	50	0.1000	0.13		<b>Sheet Flow,</b> Woods: Light underbrush n= 0.400 P2= 3.30"
0.7	52	0.0570	1.19		<b>Shallow Concentrated Flow,</b> Woodland Kv= 5.0 fps
0.3	34	0.0580	1.69		<b>Shallow Concentrated Flow,</b> Short Grass Pasture Kv= 7.0 fps
7.4	136	Total			

**Cole Post-Development**

Prepared by Weston & Sampson

HydroCAD® 10.10-5a s/n 00455 © 2020 HydroCAD Software Solutions LLC

Type III 24-hr 10-year Rainfall=4.70"

Printed 7/12/2021

Page 41

**Subcatchment A8: SUB-A8**

Hydrograph

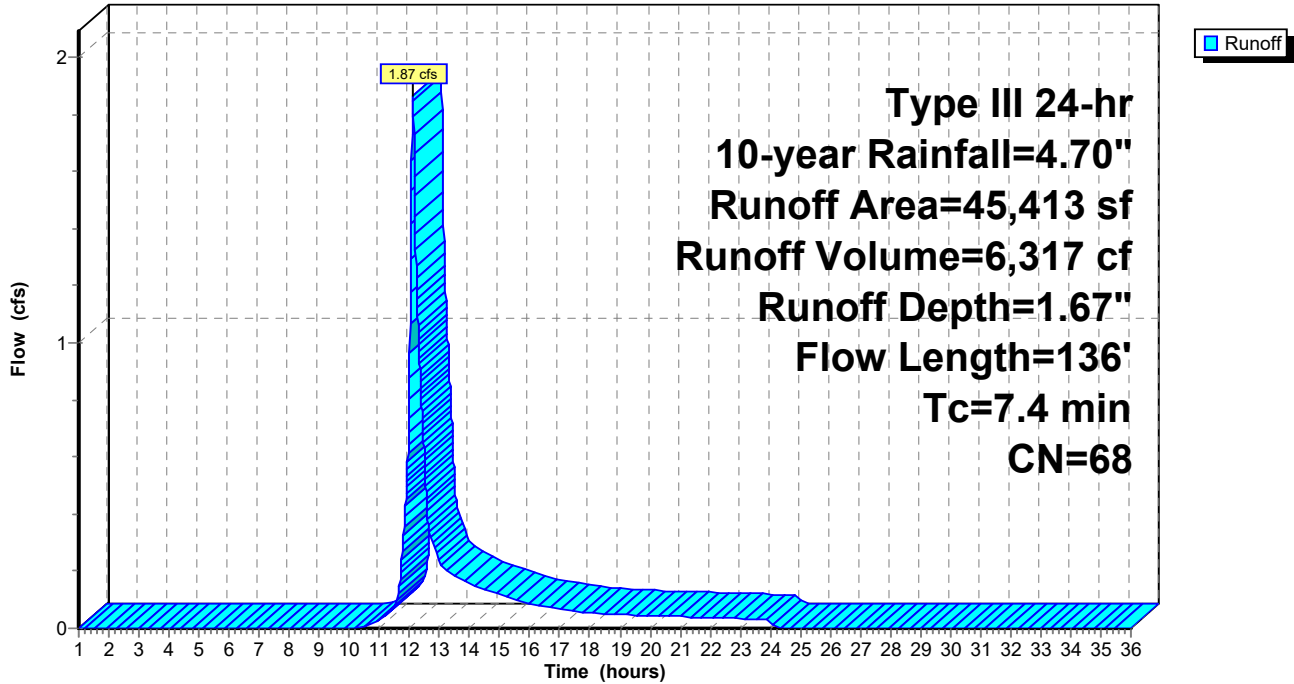

# Cole Post-Development

Prepared by Weston & Sampson

HydroCAD® 10.10-5a s/n 00455 © 2020 HydroCAD Software Solutions LLC

Type III 24-hr 10-year Rainfall=4.70"

Printed 7/12/2021

Page 42

## Summary for Subcatchment B1: SUB-B1

Runoff = 0.16 cfs @ 12.10 hrs, Volume= 556 cf, Depth= 1.13"

Runoff by SCS TR-20 method, UH=SCS, Weighted-CN, Time Span= 1.00-36.00 hrs, dt= 0.01 hrs  
Type III 24-hr 10-year Rainfall=4.70"

Area (sf)	CN	Description
5,112	61	>75% Grass cover, Good, HSG B
795	55	Woods, Good, HSG B
5,907	60	Weighted Average
5,907		100.00% Pervious Area

Tc (min)	Length (feet)	Slope (ft/ft)	Velocity (ft/sec)	Capacity (cfs)	Description
6.0					Direct Entry,

## Subcatchment B1: SUB-B1

Hydrograph

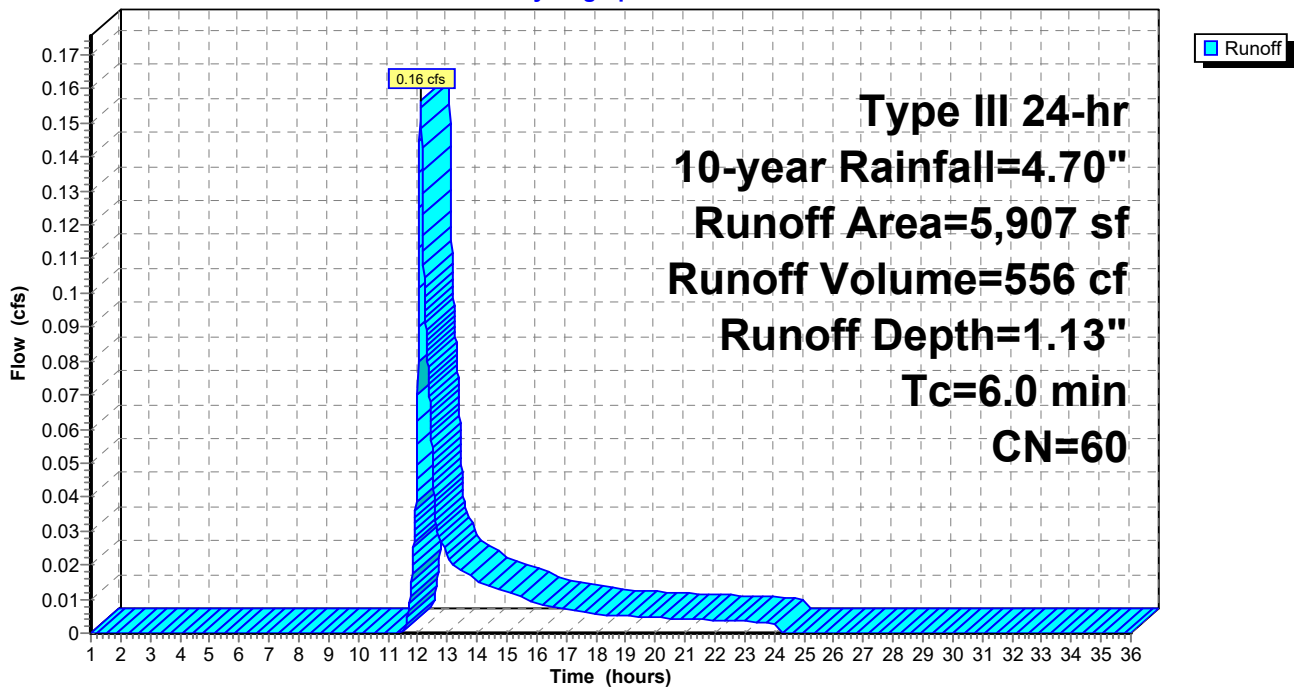

# Cole Post-Development

Prepared by Weston & Sampson

HydroCAD® 10.10-5a s/n 00455 © 2020 HydroCAD Software Solutions LLC

Type III 24-hr 10-year Rainfall=4.70"

Printed 7/12/2021

Page 43

## Summary for Pond A: POI-A

Inflow Area = 296,839 sf, 54.99% Impervious, Inflow Depth = 1.78" for 10-year event  
Inflow = 11.11 cfs @ 12.11 hrs, Volume= 43,944 cf  
Primary = 11.11 cfs @ 12.11 hrs, Volume= 43,944 cf, Atten= 0%, Lag= 0.0 min

Routing by Dyn-Stor-Ind method, Time Span= 1.00-36.00 hrs, dt= 0.01 hrs

### Pond A: POI-A

Hydrograph

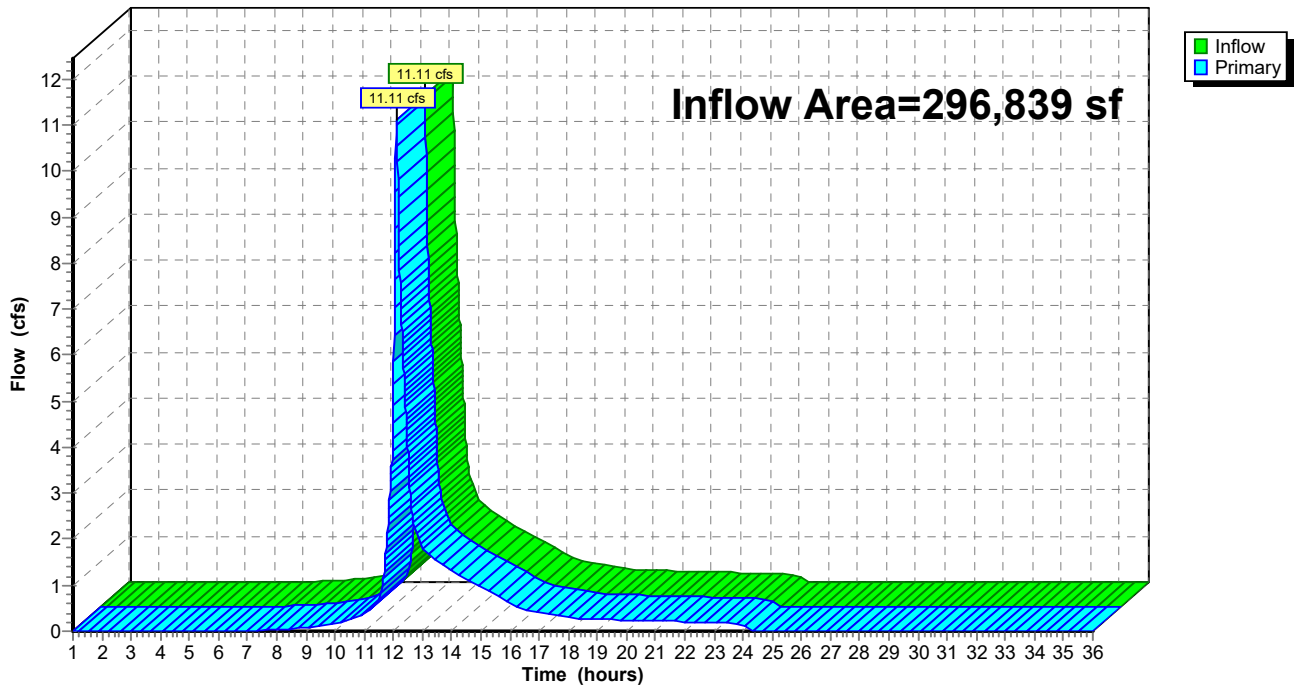

# Cole Post-Development

Prepared by Weston & Sampson

HydroCAD® 10.10-5a s/n 00455 © 2020 HydroCAD Software Solutions LLC

Type III 24-hr 10-year Rainfall=4.70"

Printed 7/12/2021

Page 44

## Summary for Pond B: POI-B

Inflow Area = 5,907 sf, 0.00% Impervious, Inflow Depth = 1.13" for 10-year event  
Inflow = 0.16 cfs @ 12.10 hrs, Volume= 556 cf  
Primary = 0.16 cfs @ 12.10 hrs, Volume= 556 cf, Atten= 0%, Lag= 0.0 min

Routing by Dyn-Stor-Ind method, Time Span= 1.00-36.00 hrs, dt= 0.01 hrs

### Pond B: POI-B

Hydrograph

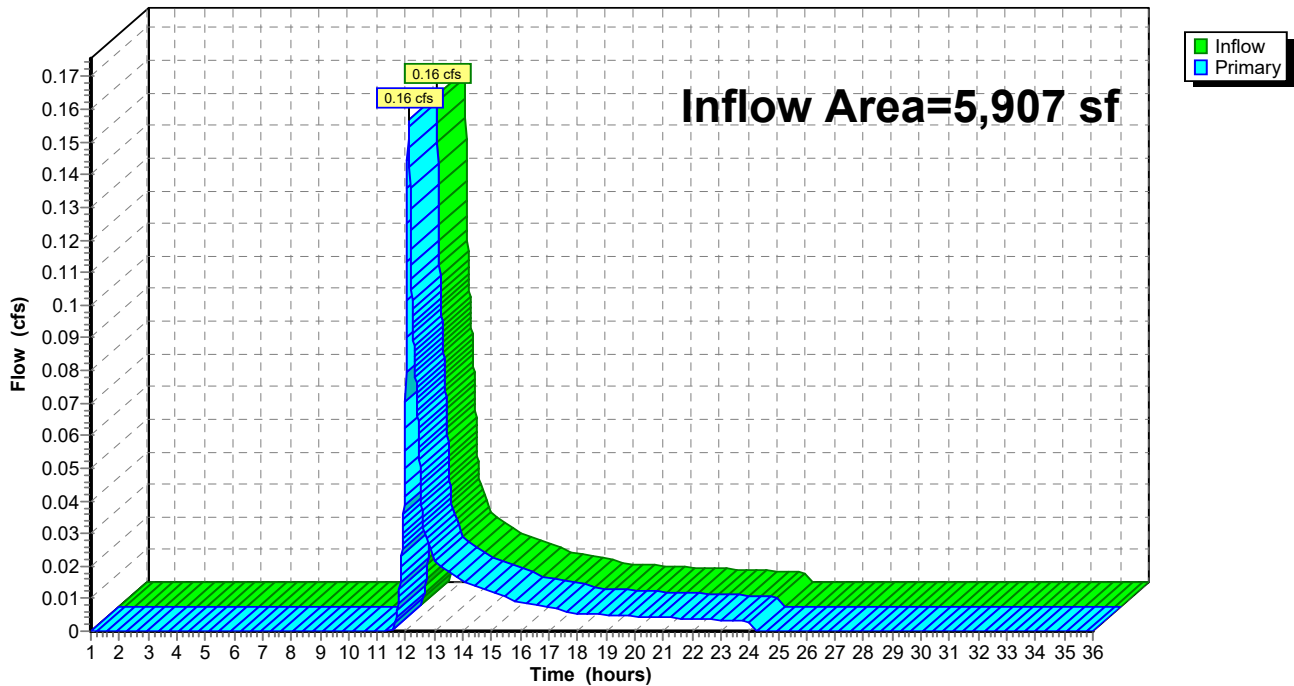



**Cole Post-Development**

Prepared by Weston & Sampson

HydroCAD® 10.10-5a s/n 00455 © 2020 HydroCAD Software Solutions LLC

Type III 24-hr 10-year Rainfall=4.70"

Printed 7/12/2021

Page 45

**Summary for Pond BR-1: BR-1**

Inflow Area = 16,500 sf, 77.45% Impervious, Inflow Depth = 3.19" for 10-year event  
 Inflow = 1.40 cfs @ 12.09 hrs, Volume= 4,384 cf  
 Outflow = 1.09 cfs @ 12.15 hrs, Volume= 3,573 cf, Atten= 22%, Lag= 3.8 min  
 Primary = 1.09 cfs @ 12.15 hrs, Volume= 3,573 cf  
 Secondary = 0.00 cfs @ 1.00 hrs, Volume= 0 cf

Routing by Dyn-Stor-Ind method, Time Span= 1.00-36.00 hrs, dt= 0.01 hrs  
 Peak Elev= 101.15' @ 12.15 hrs Surf.Area= 396 sf Storage= 933 cf

Plug-Flow detention time= 111.1 min calculated for 3,572 cf (81% of inflow)  
 Center-of-Mass det. time= 38.5 min ( 845.3 - 806.8 )

Volume	Invert	Avail.Storage	Storage Description	
#1	96.74'	1,245 cf	<b>Custom Stage Data (Prismatic)</b> Listed below (Recalc)	
Elevation (feet)	Surf.Area (sq-ft)	Voids (%)	Inc.Store (cubic-feet)	Cum.Store (cubic-feet)
96.74	641	0.0	0	0
96.75	641	40.0	3	3
97.24	641	40.0	126	128
97.25	641	30.0	2	130
100.24	641	30.0	575	705
100.25	641	40.0	3	708
100.49	641	40.0	62	769
100.50	88	100.0	4	773
101.00	335	100.0	106	879
101.75	641	100.0	366	1,245

Device	Routing	Invert	Outlet Devices
#1	Device 2	100.75'	<b>24.0" Horiz. Orifice/Grate</b> C= 0.600 Limited to weir flow at low heads
#2	Primary	94.49'	<b>12.0" Round Culvert</b> L= 62.8' CPP, projecting, no headwall, Ke= 0.900 Inlet / Outlet Invert= 94.49' / 94.18' S= 0.0049 '/' Cc= 0.900 n= 0.130, Flow Area= 0.79 sf
#3	Secondary	101.25'	<b>15.0' long x 10.0' breadth Broad-Crested Rectangular Weir</b> Head (feet) 0.20 0.40 0.60 0.80 1.00 1.20 1.40 1.60 Coef. (English) 2.49 2.56 2.70 2.69 2.68 2.69 2.67 2.64

**Primary OutFlow** Max=1.09 cfs @ 12.15 hrs HW=101.15' TW=94.51' (Dynamic Tailwater)

↑ **2=Culvert** (Barrel Controls 1.09 cfs @ 1.39 fps)

↑ **1=Orifice/Grate** (Passes 1.09 cfs of 5.18 cfs potential flow)

**Secondary OutFlow** Max=0.00 cfs @ 1.00 hrs HW=96.74' TW=92.50' (Dynamic Tailwater)

↑ **3=Broad-Crested Rectangular Weir** ( Controls 0.00 cfs)

# Cole Post-Development

Prepared by Weston & Sampson

HydroCAD® 10.10-5a s/n 00455 © 2020 HydroCAD Software Solutions LLC

Type III 24-hr 10-year Rainfall=4.70"

Printed 7/12/2021

Page 46

## Pond BR-1: BR-1

Hydrograph

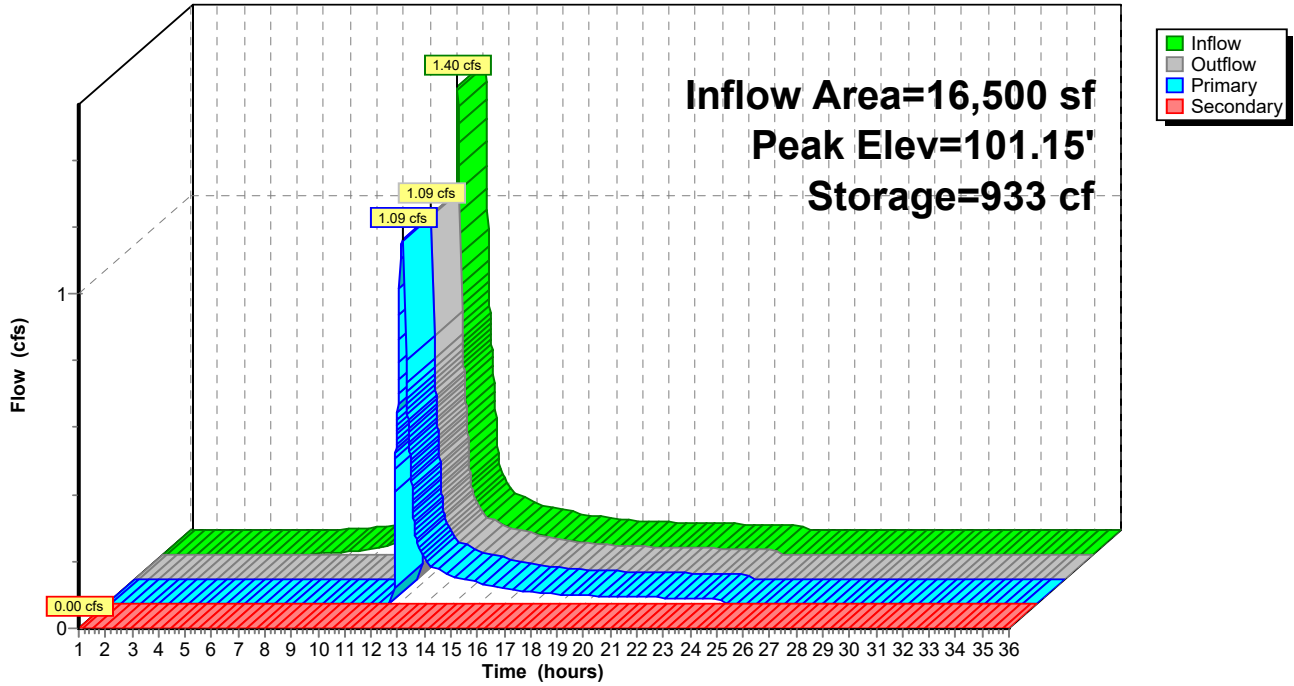

# Cole Post-Development

Prepared by Weston & Sampson

HydroCAD® 10.10-5a s/n 00455 © 2020 HydroCAD Software Solutions LLC

Type III 24-hr 10-year Rainfall=4.70"

Printed 7/12/2021

Page 47

## Summary for Pond DS-1: DS-1

Inflow Area = 35,193 sf, 61.85% Impervious, Inflow Depth = 2.37" for 10-year event  
Inflow = 2.03 cfs @ 12.13 hrs, Volume= 6,963 cf  
Outflow = 2.01 cfs @ 12.14 hrs, Volume= 6,962 cf, Atten= 1%, Lag= 0.9 min  
Primary = 2.01 cfs @ 12.14 hrs, Volume= 6,962 cf

Routing by Dyn-Stor-Ind method, Time Span= 1.00-36.00 hrs, dt= 0.01 hrs  
Peak Elev= 90.21' @ 12.14 hrs Surf.Area= 658 sf Storage= 846 cf

Plug-Flow detention time= 20.1 min calculated for 6,960 cf (100% of inflow)  
Center-of-Mass det. time= 20.1 min ( 855.4 - 835.3 )

Volume	Invert	Avail.Storage	Storage Description
#1A	88.25'	627 cf	<b>20.50'W x 32.10'L x 3.50'H Field A</b> 2,303 cf Overall - 735 cf Embedded = 1,568 cf x 40.0% Voids
#2A	88.75'	735 cf	<b>ADS_StormTech SC-740 +Cap</b> x 16 Inside #1 Effective Size= 44.6"W x 30.0"H => 6.45 sf x 7.12'L = 45.9 cf Overall Size= 51.0"W x 30.0"H x 7.56'L with 0.44' Overlap 16 Chambers in 4 Rows
		1,362 cf	Total Available Storage

Storage Group A created with Chamber Wizard

Device	Routing	Invert	Outlet Devices
#1	Primary	88.25'	<b>24.0" Round Culvert</b> L= 26.9' CPP, projecting, no headwall, Ke= 0.900 Inlet / Outlet Invert= 88.25' / 88.12' S= 0.0048 '/' Cc= 0.900 n= 0.013 Corrugated PE, smooth interior, Flow Area= 3.14 sf
#2	Device 1	89.95'	<b>4.0' long Sharp-Crested Rectangular Weir</b> 2 End Contraction(s)
#3	Device 1	88.25'	<b>3.0" Vert. Orifice/Grate</b> C= 0.600 Limited to weir flow at low heads

**Primary OutFlow** Max=2.01 cfs @ 12.14 hrs HW=90.21' TW=0.00' (Dynamic Tailwater)

1=Culvert (Passes 2.01 cfs of 10.62 cfs potential flow)

2=Sharp-Crested Rectangular Weir (Weir Controls 1.69 cfs @ 1.66 fps)

3=Orifice/Grate (Orifice Controls 0.32 cfs @ 6.52 fps)

# Cole Post-Development

Prepared by Weston & Sampson

HydroCAD® 10.10-5a s/n 00455 © 2020 HydroCAD Software Solutions LLC

Type III 24-hr 10-year Rainfall=4.70"

Printed 7/12/2021

Page 48

## Pond DS-1: DS-1 - Chamber Wizard Field A

**Chamber Model = ADS\_StormTechSC-740 +Cap (ADS StormTech®SC-740 with cap length)**

Effective Size= 44.6"W x 30.0"H => 6.45 sf x 7.12'L = 45.9 cf

Overall Size= 51.0"W x 30.0"H x 7.56'L with 0.44' Overlap

51.0" Wide + 6.0" Spacing = 57.0" C-C Row Spacing

4 Chambers/Row x 7.12' Long +0.81' Cap Length x 2 = 30.10' Row Length +12.0" End Stone x 2 = 32.10' Base Length

4 Rows x 51.0" Wide + 6.0" Spacing x 3 + 12.0" Side Stone x 2 = 20.50' Base Width

6.0" Stone Base + 30.0" Chamber Height + 6.0" Stone Cover = 3.50' Field Height

16 Chambers x 45.9 cf = 735.0 cf Chamber Storage

2,302.9 cf Field - 735.0 cf Chambers = 1,567.9 cf Stone x 40.0% Voids = 627.2 cf Stone Storage

Chamber Storage + Stone Storage = 1,362.2 cf = 0.031 af

Overall Storage Efficiency = 59.2%

Overall System Size = 32.10' x 20.50' x 3.50'

16 Chambers

85.3 cy Field

58.1 cy Stone

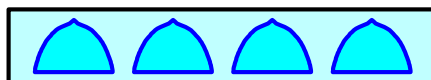
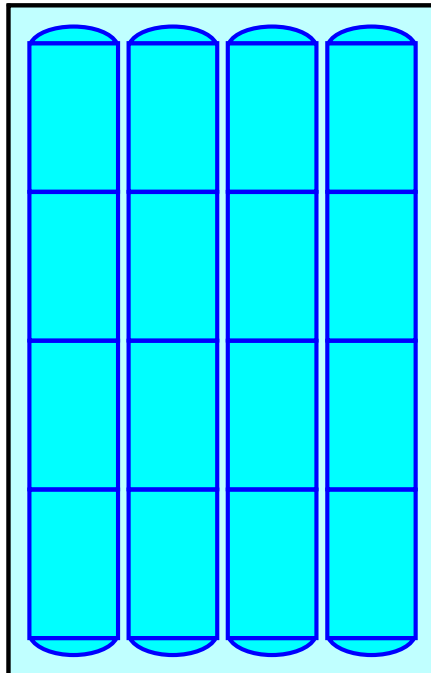

**Cole Post-Development**

Prepared by Weston & Sampson

HydroCAD® 10.10-5a s/n 00455 © 2020 HydroCAD Software Solutions LLC

Type III 24-hr 10-year Rainfall=4.70"

Printed 7/12/2021

Page 49

**Pond DS-1: DS-1**

Hydrograph

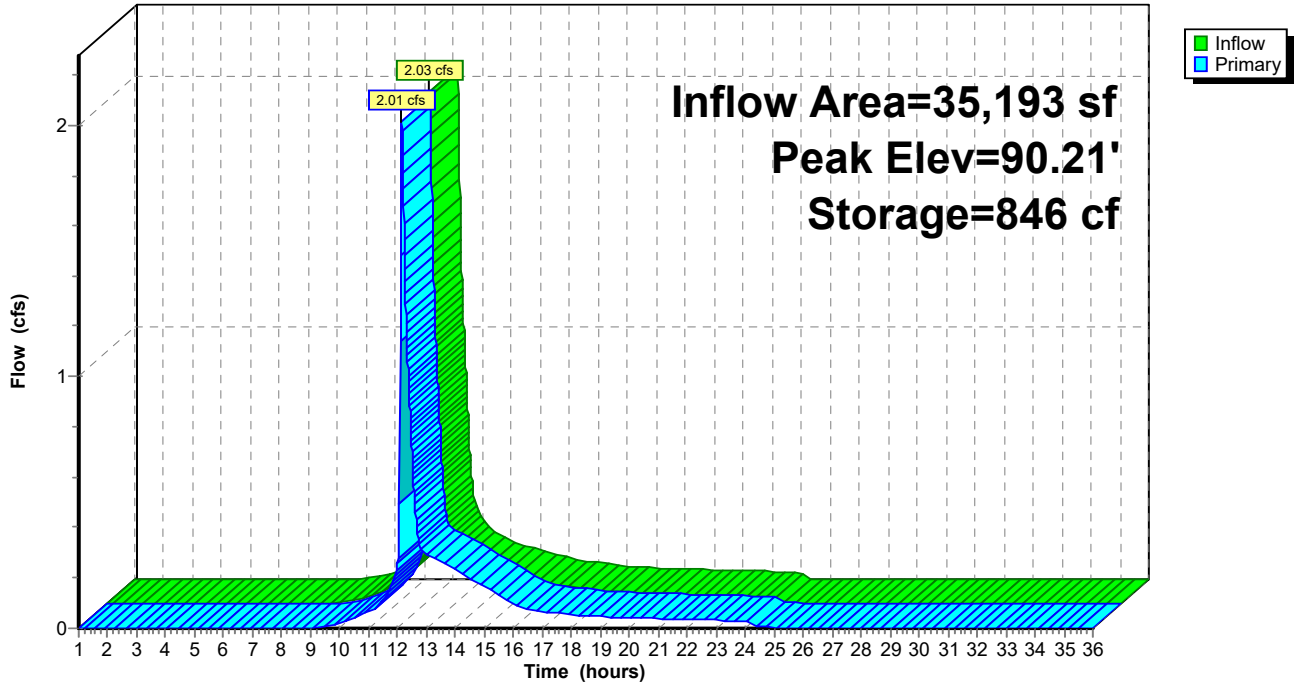

# Cole Post-Development

Prepared by Weston & Sampson

HydroCAD® 10.10-5a s/n 00455 © 2020 HydroCAD Software Solutions LLC

Type III 24-hr 10-year Rainfall=4.70"

Printed 7/12/2021

Page 50

## Summary for Pond IS-1: IS-1

Inflow Area = 61,597 sf, 85.38% Impervious, Inflow Depth = 3.48" for 10-year event  
Inflow = 5.47 cfs @ 12.09 hrs, Volume= 17,841 cf  
Outflow = 0.68 cfs @ 12.72 hrs, Volume= 17,841 cf, Atten= 88%, Lag= 38.0 min  
Discarded = 0.25 cfs @ 12.72 hrs, Volume= 13,230 cf  
Primary = 0.43 cfs @ 12.72 hrs, Volume= 4,612 cf

Routing by Dyn-Stor-Ind method, Time Span= 1.00-36.00 hrs, dt= 0.01 hrs  
Peak Elev= 95.40' @ 12.72 hrs Surf.Area= 3,603 sf Storage= 7,350 cf

Plug-Flow detention time= 160.2 min calculated for 17,841 cf (100% of inflow)  
Center-of-Mass det. time= 160.2 min ( 957.0 - 796.8 )

Volume	Invert	Avail.Storage	Storage Description
#1A	92.50'	5,063 cf	<b>29.92'W x 120.42'L x 5.50'H Field A</b> 19,814 cf Overall - 7,156 cf Embedded = 12,658 cf x 40.0% Voids
#2A	93.25'	7,156 cf	<b>ADS_StormTech MC-3500 d +Capx 64</b> Inside #1 Effective Size= 70.4"W x 45.0"H => 15.33 sf x 7.17'L = 110.0 cf Overall Size= 77.0"W x 45.0"H x 7.50'L with 0.33' Overlap 64 Chambers in 4 Rows Cap Storage= +14.9 cf x 2 x 4 rows = 119.2 cf
		12,219 cf	Total Available Storage

Storage Group A created with Chamber Wizard

Device	Routing	Invert	Outlet Devices
#1	Discarded	92.50'	<b>2.410 in/hr Exfiltration over Wetted area</b> Phase-In= 0.01'
#2	Primary	92.00'	<b>12.0" Round Culvert</b> L= 91.3' CPP, projecting, no headwall, Ke= 0.900 Inlet / Outlet Invert= 92.00' / 91.09' S= 0.0100 '/' Cc= 0.900 n= 0.013 Corrugated PE, smooth interior, Flow Area= 0.79 sf
#3	Device 2	97.00'	<b>4.0' long Sharp-Crested Rectangular Weir</b> 2 End Contraction(s)
#4	Device 2	94.20'	<b>4.0" Vert. Orifice/Grate</b> C= 0.600 Limited to weir flow at low heads

**Discarded OutFlow** Max=0.25 cfs @ 12.72 hrs HW=95.40' (Free Discharge)

↑1=Exfiltration (Exfiltration Controls 0.25 cfs)

**Primary OutFlow** Max=0.43 cfs @ 12.72 hrs HW=95.40' TW=0.00' (Dynamic Tailwater)

↑2=Culvert (Passes 0.43 cfs of 5.09 cfs potential flow)

↑3=Sharp-Crested Rectangular Weir( Controls 0.00 cfs)

↑4=Orifice/Grate (Orifice Controls 0.43 cfs @ 4.90 fps)

# Cole Post-Development

Prepared by Weston & Sampson

HydroCAD® 10.10-5a s/n 00455 © 2020 HydroCAD Software Solutions LLC

Type III 24-hr 10-year Rainfall=4.70"

Printed 7/12/2021

Page 51

## Pond IS-1: IS-1 - Chamber Wizard Field A

**Chamber Model = ADS\_StormTechMC-3500 d +Cap (ADS StormTech®MC-3500 d rev 03/14 with Cap volume)**

Effective Size= 70.4"W x 45.0"H => 15.33 sf x 7.17'L = 110.0 cf

Overall Size= 77.0"W x 45.0"H x 7.50'L with 0.33' Overlap

Cap Storage= +14.9 cf x 2 x 4 rows = 119.2 cf

77.0" Wide + 9.0" Spacing = 86.0" C-C Row Spacing

16 Chambers/Row x 7.17' Long +1.85' Cap Length x 2 = 118.42' Row Length +12.0" End Stone x 2 = 120.42' Base Length

4 Rows x 77.0" Wide + 9.0" Spacing x 3 + 12.0" Side Stone x 2 = 29.92' Base Width

9.0" Stone Base + 45.0" Chamber Height + 12.0" Stone Cover = 5.50' Field Height

64 Chambers x 110.0 cf + 14.9 cf Cap Volume x 2 x 4 Rows = 7,156.1 cf Chamber Storage

19,814.1 cf Field - 7,156.1 cf Chambers = 12,658.0 cf Stone x 40.0% Voids = 5,063.2 cf Stone Storage

Chamber Storage + Stone Storage = 12,219.3 cf = 0.281 af

Overall Storage Efficiency = 61.7%

Overall System Size = 120.42' x 29.92' x 5.50'

64 Chambers

733.9 cy Field

468.8 cy Stone

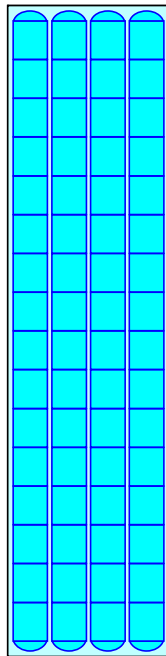

# Cole Post-Development

Prepared by Weston & Sampson

HydroCAD® 10.10-5a s/n 00455 © 2020 HydroCAD Software Solutions LLC

Type III 24-hr 10-year Rainfall=4.70"

Printed 7/12/2021

Page 52

## Pond IS-1: IS-1

Hydrograph

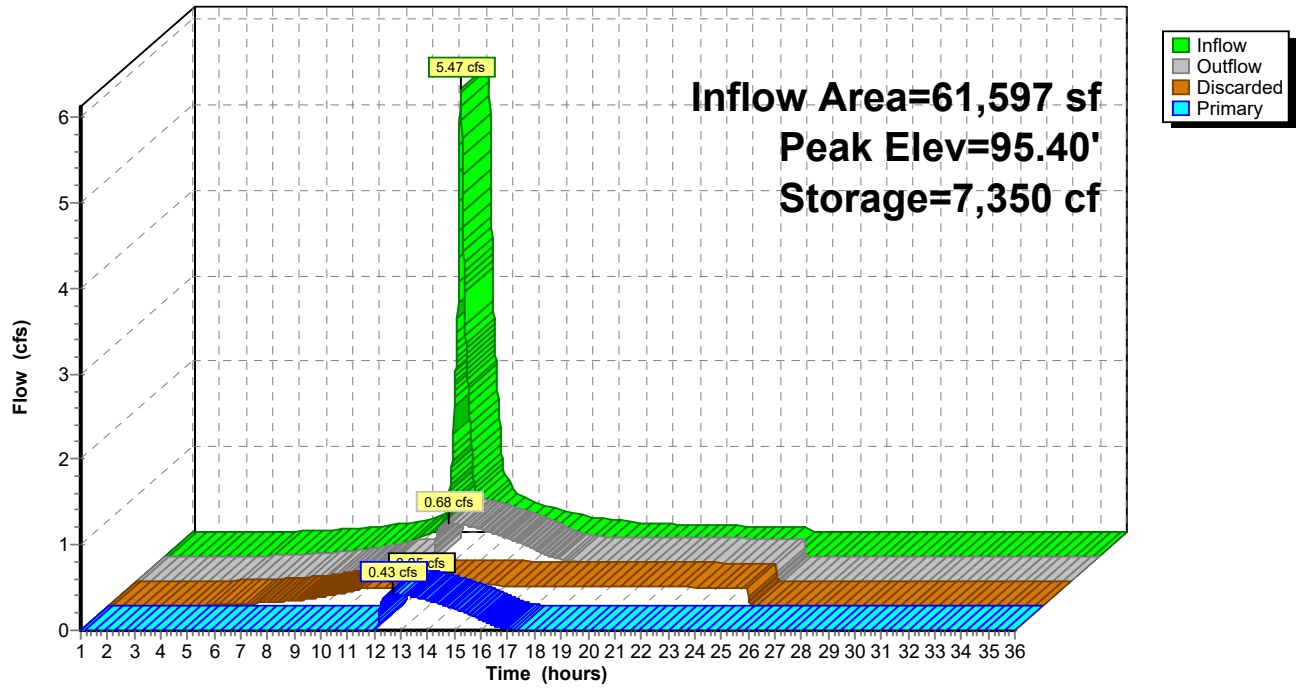



**Cole Post-Development**

Prepared by Weston &amp; Sampson

HydroCAD® 10.10-5a s/n 00455 © 2020 HydroCAD Software Solutions LLC

Type III 24-hr 25-year Rainfall=5.80"

Printed 7/12/2021

Page 53

Time span=1.00-36.00 hrs, dt=0.01 hrs, 3501 points  
 Runoff by SCS TR-20 method, UH=SCS, Weighted-CN  
 Reach routing by Dyn-Stor-Ind method - Pond routing by Dyn-Stor-Ind method

**SubcatchmentA1: SUB-A1** Runoff Area=67,238 sf 64.49% Impervious Runoff Depth=4.11"  
 Tc=6.0 min CN=85 Runoff=7.32 cfs 23,052 cf

**SubcatchmentA2: SUB-A2** Runoff Area=35,193 sf 61.85% Impervious Runoff Depth=3.31"  
 Flow Length=160' Tc=8.9 min CN=77 Runoff=2.83 cfs 9,693 cf

**SubcatchmentA3: SUB-A3** Runoff Area=16,500 sf 77.45% Impervious Runoff Depth=4.22"  
 Tc=6.0 min CN=86 Runoff=1.83 cfs 5,802 cf

**SubcatchmentA4: SUB-A4** Runoff Area=45,097 sf 88.28% Impervious Runoff Depth=4.87"  
 Tc=6.0 min CN=92 Runoff=5.56 cfs 18,313 cf

**SubcatchmentA5: SUB-A2** Runoff Area=11,510 sf 59.26% Impervious Runoff Depth=3.02"  
 Tc=6.0 min CN=74 Runoff=0.93 cfs 2,894 cf

**SubcatchmentA6: SUB-A4** Runoff Area=44,811 sf 26.24% Impervious Runoff Depth=1.63"  
 Flow Length=463' Tc=12.7 min CN=58 Runoff=1.44 cfs 6,100 cf

**SubcatchmentA7: SUB-A7** Runoff Area=31,077 sf 11.00% Impervious Runoff Depth=1.79"  
 Tc=6.0 min CN=60 Runoff=1.41 cfs 4,641 cf

**SubcatchmentA8: SUB-A8** Runoff Area=45,413 sf 51.78% Impervious Runoff Depth=2.47"  
 Flow Length=136' Tc=7.4 min CN=68 Runoff=2.83 cfs 9,341 cf

**SubcatchmentB1: SUB-B1** Runoff Area=5,907 sf 0.00% Impervious Runoff Depth=1.79"  
 Tc=6.0 min CN=60 Runoff=0.27 cfs 882 cf

**Pond A: POI-A** Inflow=16.32 cfs 64,044 cf  
 Primary=16.32 cfs 64,044 cf

**Pond B: POI-B** Inflow=0.27 cfs 882 cf  
 Primary=0.27 cfs 882 cf

**Pond BR-1: BR-1** Peak Elev=101.32' Storage=1,005 cf Inflow=1.83 cfs 5,802 cf  
 Primary=1.11 cfs 4,828 cf Secondary=0.65 cfs 163 cf Outflow=1.76 cfs 4,992 cf

**Pond DS-1: DS-1** Peak Elev=90.28' Storage=880 cf Inflow=2.83 cfs 9,693 cf  
 Outflow=2.82 cfs 9,692 cf

**Pond IS-1: IS-1** Peak Elev=96.54' Storage=10,035 cf Inflow=7.14 cfs 23,305 cf  
 Discarded=0.27 cfs 14,982 cf Primary=0.62 cfs 8,323 cf Outflow=0.89 cfs 23,305 cf

**Total Runoff Area = 302,746 sf Runoff Volume = 80,718 cf Average Runoff Depth = 3.20"**  
**46.08% Pervious = 139,512 sf 53.92% Impervious = 163,234 sf**

**Cole Post-Development**

Prepared by Weston & Sampson

HydroCAD® 10.10-5a s/n 00455 © 2020 HydroCAD Software Solutions LLC

Type III 24-hr 25-year Rainfall=5.80"

Printed 7/12/2021

Page 54

**Summary for Subcatchment A1: SUB-A1**

Runoff = 7.32 cfs @ 12.09 hrs, Volume= 23,052 cf, Depth= 4.11"

Runoff by SCS TR-20 method, UH=SCS, Weighted-CN, Time Span= 1.00-36.00 hrs, dt= 0.01 hrs  
Type III 24-hr 25-year Rainfall=5.80"

	Area (sf)	CN	Description
*	27,200	98	Paved Impervious, HSG B
	16,163	98	Roofs, HSG B
	23,006	61	>75% Grass cover, Good, HSG B
	869	55	Woods, Good, HSG B
	67,238	85	Weighted Average
	23,875		35.51% Pervious Area
	43,363		64.49% Impervious Area

Tc (min)	Length (feet)	Slope (ft/ft)	Velocity (ft/sec)	Capacity (cfs)	Description
6.0					Direct Entry,

**Subcatchment A1: SUB-A1**

Hydrograph

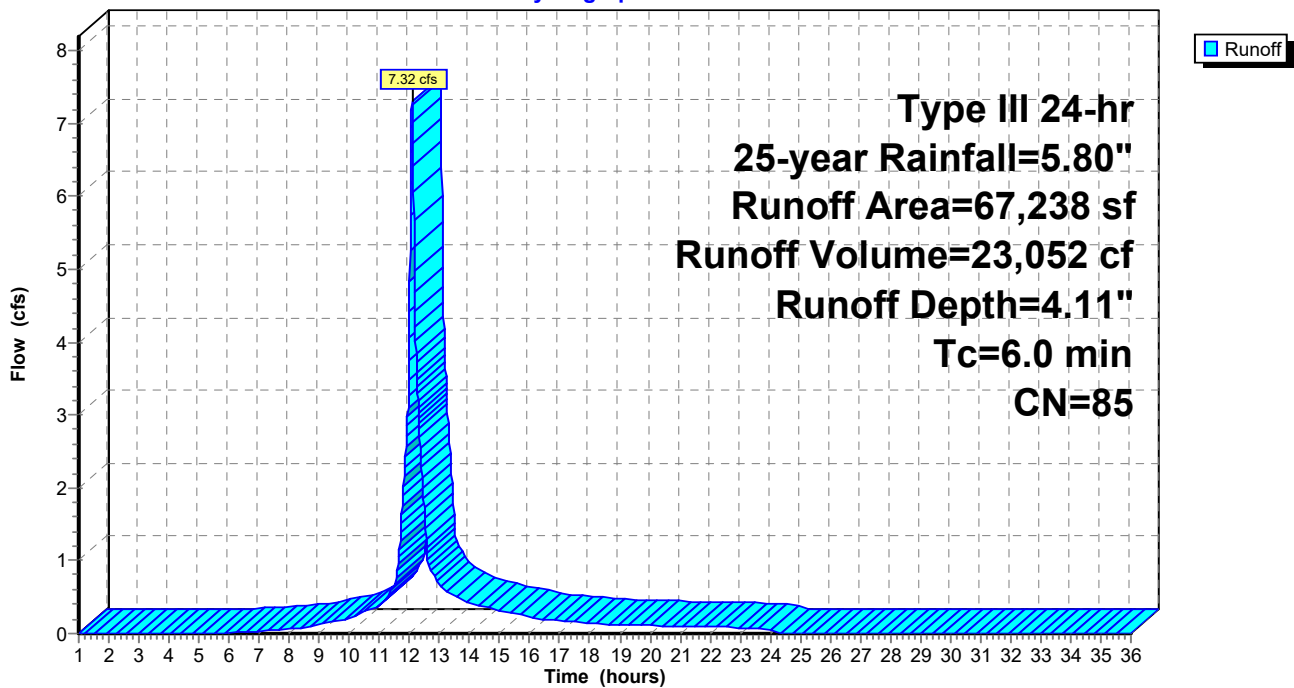

**Cole Post-Development**

Prepared by Weston & Sampson

HydroCAD® 10.10-5a s/n 00455 © 2020 HydroCAD Software Solutions LLC

Type III 24-hr 25-year Rainfall=5.80"

Printed 7/12/2021

Page 55

**Summary for Subcatchment A2: SUB-A2**

Runoff = 2.83 cfs @ 12.13 hrs, Volume= 9,693 cf, Depth= 3.31"

Runoff by SCS TR-20 method, UH=SCS, Weighted-CN, Time Span= 1.00-36.00 hrs, dt= 0.01 hrs  
Type III 24-hr 25-year Rainfall=5.80"

Area (sf)	CN	Description
* 23	98	Paved Impervious, HSG A
* 18,246	98	Paved Impervious, HSG B
3,498	98	Roofs, HSG B
1,694	39	>75% Grass cover, Good, HSG A
4,693	61	>75% Grass cover, Good, HSG B
6,952	30	Woods, Good, HSG A
87	55	Woods, Good, HSG B
35,193	77	Weighted Average
13,426		38.15% Pervious Area
21,767		61.85% Impervious Area

Tc (min)	Length (feet)	Slope (ft/ft)	Velocity (ft/sec)	Capacity (cfs)	Description
7.4	50	0.0700	0.11		<b>Sheet Flow,</b> Woods: Light underbrush n= 0.400 P2= 3.30"
0.5	33	0.0450	1.06		<b>Shallow Concentrated Flow,</b> Woodland Kv= 5.0 fps
0.9	59	0.0250	1.11		<b>Shallow Concentrated Flow,</b> Short Grass Pasture Kv= 7.0 fps
0.1	18	0.0150	2.49		<b>Shallow Concentrated Flow,</b> Paved Kv= 20.3 fps
8.9	160	Total			

**Cole Post-Development**

Prepared by Weston & Sampson

HydroCAD® 10.10-5a s/n 00455 © 2020 HydroCAD Software Solutions LLC

Type III 24-hr 25-year Rainfall=5.80"

Printed 7/12/2021

Page 56

**Subcatchment A2: SUB-A2**

Hydrograph

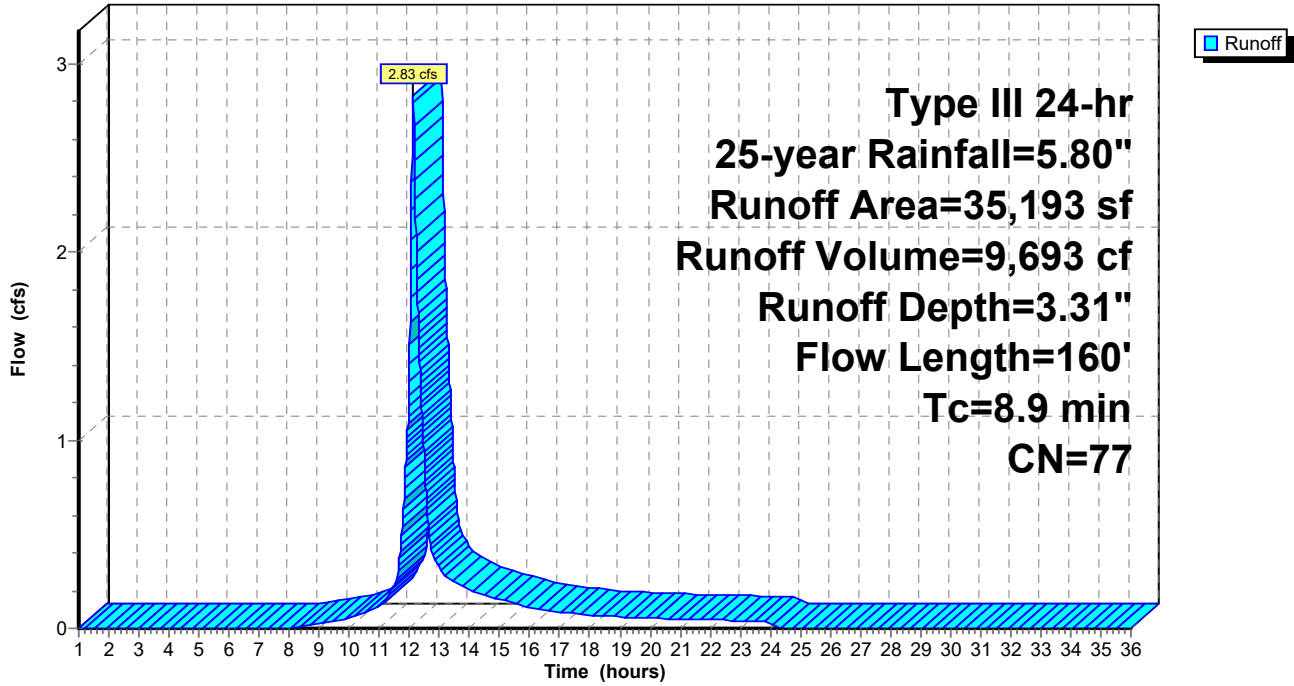

**Cole Post-Development**

Prepared by Weston & Sampson

HydroCAD® 10.10-5a s/n 00455 © 2020 HydroCAD Software Solutions LLC

Type III 24-hr 25-year Rainfall=5.80"

Printed 7/12/2021

Page 57

**Summary for Subcatchment A3: SUB-A3**

Runoff = 1.83 cfs @ 12.09 hrs, Volume= 5,802 cf, Depth= 4.22"

Runoff by SCS TR-20 method, UH=SCS, Weighted-CN, Time Span= 1.00-36.00 hrs, dt= 0.01 hrs  
Type III 24-hr 25-year Rainfall=5.80"

	Area (sf)	CN	Description
*	4,196	98	Paved Impervious, HSG A
*	1,717	98	Paved Impervious, HSG B
	6,866	98	Roofs, HSG B
	2,808	39	>75% Grass cover, Good, HSG A
	913	61	>75% Grass cover, Good, HSG B
	16,500	86	Weighted Average
	3,721		22.55% Pervious Area
	12,779		77.45% Impervious Area

Tc (min)	Length (feet)	Slope (ft/ft)	Velocity (ft/sec)	Capacity (cfs)	Description
6.0					Direct Entry,

**Subcatchment A3: SUB-A3**

Hydrograph

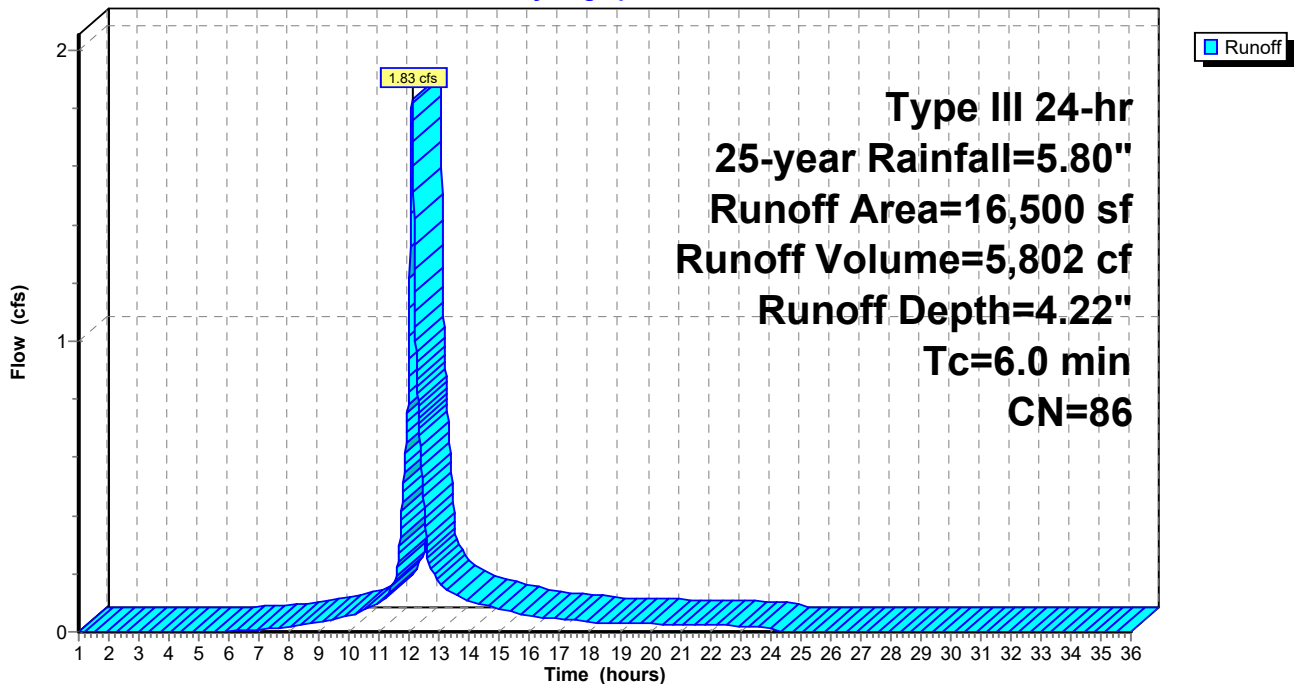

**Cole Post-Development**

Prepared by Weston & Sampson

HydroCAD® 10.10-5a s/n 00455 © 2020 HydroCAD Software Solutions LLC

Type III 24-hr 25-year Rainfall=5.80"

Printed 7/12/2021

Page 58

**Summary for Subcatchment A4: SUB-A4**

Runoff = 5.56 cfs @ 12.08 hrs, Volume= 18,313 cf, Depth= 4.87"

Runoff by SCS TR-20 method, UH=SCS, Weighted-CN, Time Span= 1.00-36.00 hrs, dt= 0.01 hrs  
 Type III 24-hr 25-year Rainfall=5.80"

	Area (sf)	CN	Description
*	28,479	98	Paved Impervious, HSG A
*	4,701	98	Paved Impervious, HSG B
	3,540	98	Roofs, HSG A
	3,092	98	Roofs, HSG B
	3,675	39	>75% Grass cover, Good, HSG A
	1,610	61	>75% Grass cover, Good, HSG B
	45,097	92	Weighted Average
	5,285		11.72% Pervious Area
	39,812		88.28% Impervious Area

Tc (min)	Length (feet)	Slope (ft/ft)	Velocity (ft/sec)	Capacity (cfs)	Description
6.0					Direct Entry,

**Subcatchment A4: SUB-A4**

Hydrograph

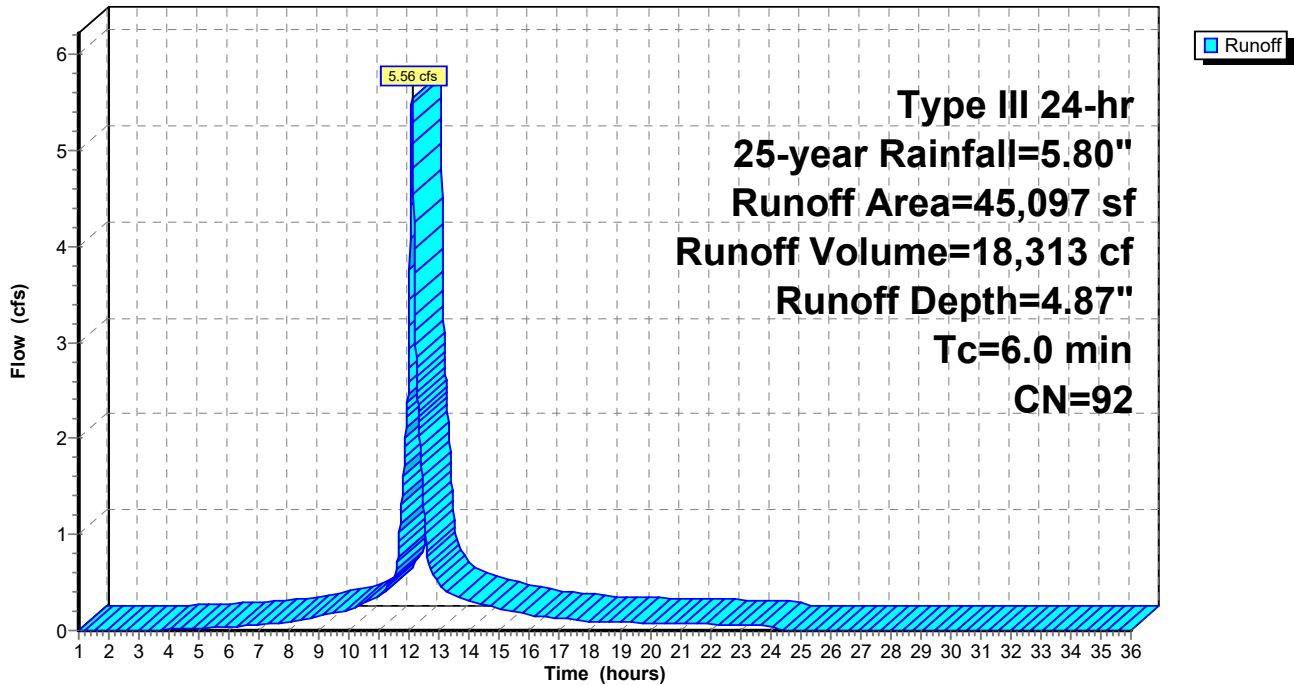

**Cole Post-Development**

Prepared by Weston & Sampson

HydroCAD® 10.10-5a s/n 00455 © 2020 HydroCAD Software Solutions LLC

Type III 24-hr 25-year Rainfall=5.80"

Printed 7/12/2021

Page 59

**Summary for Subcatchment A5: SUB-A2**

Runoff = 0.93 cfs @ 12.09 hrs, Volume= 2,894 cf, Depth= 3.02"

Runoff by SCS TR-20 method, UH=SCS, Weighted-CN, Time Span= 1.00-36.00 hrs, dt= 0.01 hrs  
Type III 24-hr 25-year Rainfall=5.80"

	Area (sf)	CN	Description
*	5,725	98	Paved Impervious, HSG A
*	1,096	98	Paved Impervious, HSG B
	4,689	39	>75% Grass cover, Good, HSG A
	11,510	74	Weighted Average
	4,689		40.74% Pervious Area
	6,821		59.26% Impervious Area

Tc (min)	Length (feet)	Slope (ft/ft)	Velocity (ft/sec)	Capacity (cfs)	Description
6.0					Direct Entry,

**Subcatchment A5: SUB-A2**

Hydrograph

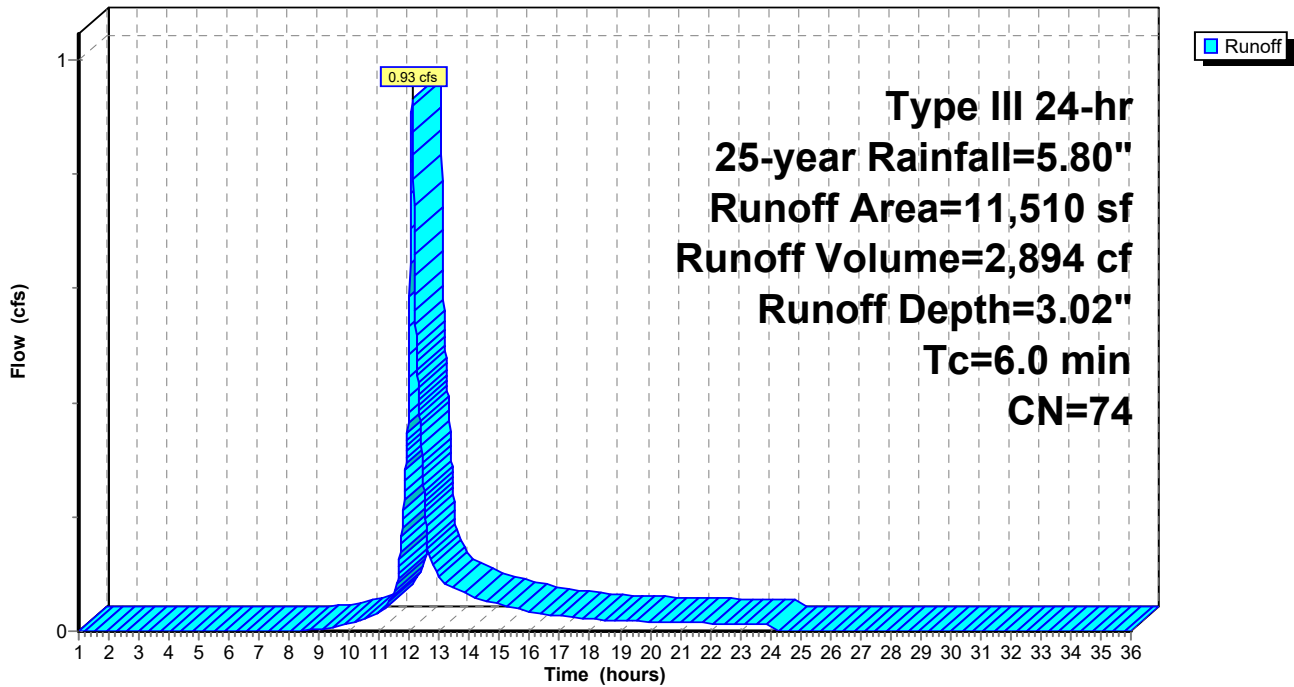

**Cole Post-Development**

Prepared by Weston & Sampson

HydroCAD® 10.10-5a s/n 00455 © 2020 HydroCAD Software Solutions LLC

Type III 24-hr 25-year Rainfall=5.80"

Printed 7/12/2021

Page 60

**Summary for Subcatchment A6: SUB-A4**

Runoff = 1.44 cfs @ 12.19 hrs, Volume= 6,100 cf, Depth= 1.63"

Runoff by SCS TR-20 method, UH=SCS, Weighted-CN, Time Span= 1.00-36.00 hrs, dt= 0.01 hrs  
Type III 24-hr 25-year Rainfall=5.80"

Area (sf)	CN	Description
* 3,625	98	Paved Impervious, HSG A
* 8,132	98	Paved Impervious, HSG B
13,635	30	Woods, Good, HSG A
13,102	55	Woods, Good, HSG B
2,357	39	>75% Grass cover, Good, HSG A
3,960	61	>75% Grass cover, Good, HSG B
44,811	58	Weighted Average
33,054		73.76% Pervious Area
11,757		26.24% Impervious Area

Tc (min)	Length (feet)	Slope (ft/ft)	Velocity (ft/sec)	Capacity (cfs)	Description
7.8	50	0.0600	0.11		<b>Sheet Flow,</b> Woods: Light underbrush n= 0.400 P2= 3.30"
2.5	120	0.0250	0.79		<b>Shallow Concentrated Flow,</b> Woodland Kv= 5.0 fps
2.4	293	0.0100	2.03		<b>Shallow Concentrated Flow,</b> Paved Kv= 20.3 fps
12.7	463	Total			



**Cole Post-Development**

Prepared by Weston & Sampson

HydroCAD® 10.10-5a s/n 00455 © 2020 HydroCAD Software Solutions LLC

Type III 24-hr 25-year Rainfall=5.80"

Printed 7/12/2021

Page 61

**Subcatchment A6: SUB-A4**

Hydrograph

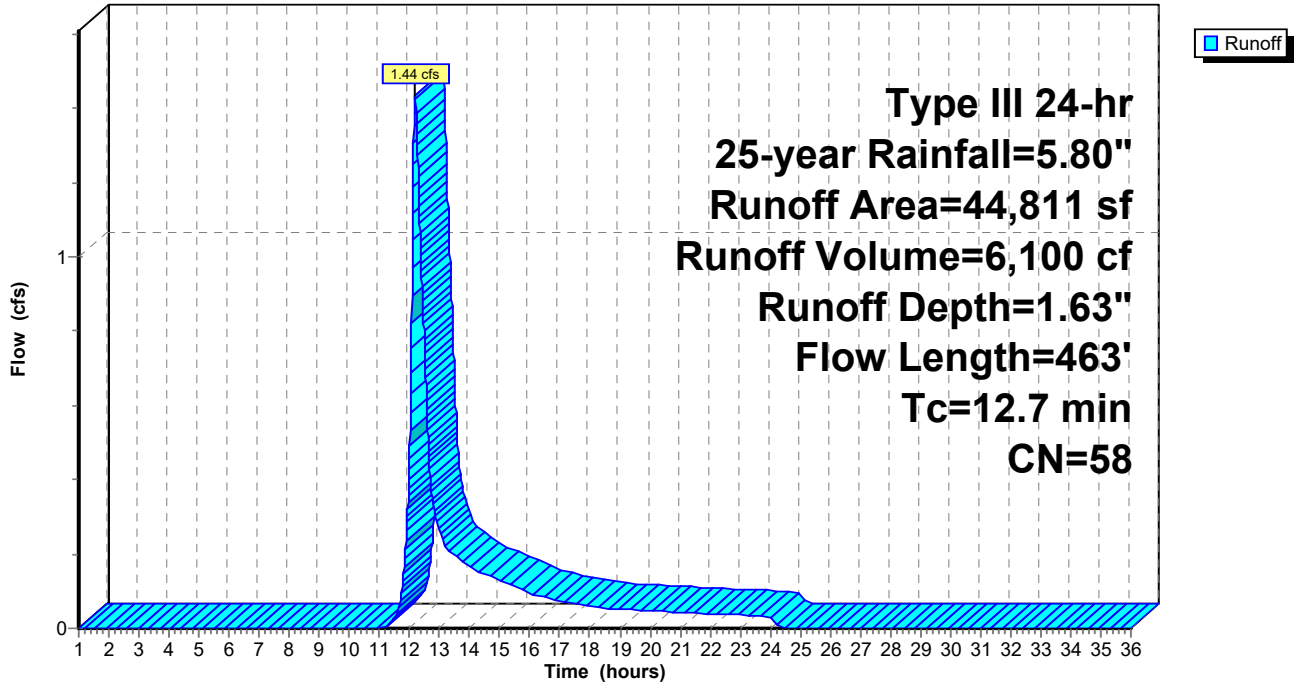

**Cole Post-Development**

Prepared by Weston & Sampson

HydroCAD® 10.10-5a s/n 00455 © 2020 HydroCAD Software Solutions LLC

Type III 24-hr 25-year Rainfall=5.80"

Printed 7/12/2021

Page 62

**Summary for Subcatchment A7: SUB-A7**

Runoff = 1.41 cfs @ 12.10 hrs, Volume= 4,641 cf, Depth= 1.79"

Runoff by SCS TR-20 method, UH=SCS, Weighted-CN, Time Span= 1.00-36.00 hrs, dt= 0.01 hrs  
Type III 24-hr 25-year Rainfall=5.80"

	Area (sf)	CN	Description
*	3,420	98	Paved Impervious, HSG B
	523	39	>75% Grass cover, Good, HSG A
	16,801	61	>75% Grass cover, Good, HSG B
	3,334	30	Woods, Good, HSG A
	6,999	55	Woods, Good, HSG B
	31,077	60	Weighted Average
	27,657		89.00% Pervious Area
	3,420		11.00% Impervious Area

Tc (min)	Length (feet)	Slope (ft/ft)	Velocity (ft/sec)	Capacity (cfs)	Description
6.0					Direct Entry,

**Subcatchment A7: SUB-A7**

Hydrograph

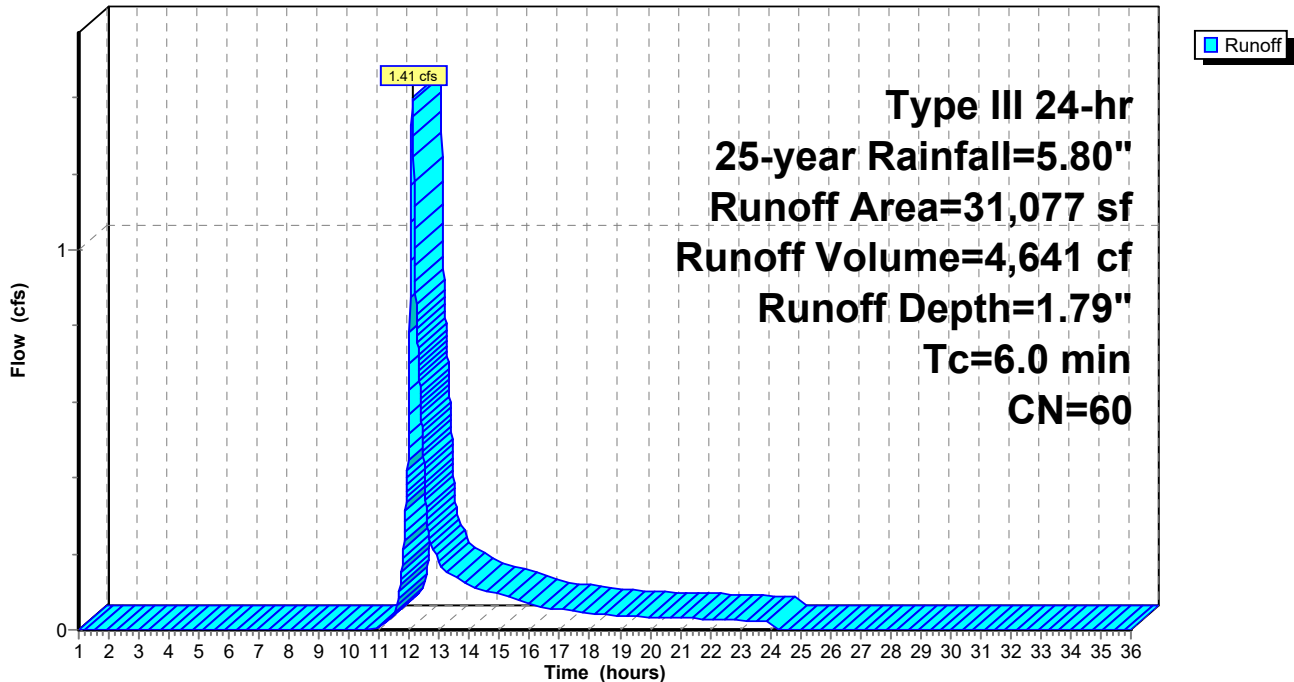

**Cole Post-Development**

Prepared by Weston & Sampson

HydroCAD® 10.10-5a s/n 00455 © 2020 HydroCAD Software Solutions LLC

Type III 24-hr 25-year Rainfall=5.80"

Printed 7/12/2021

Page 63

**Summary for Subcatchment A8: SUB-A8**

Runoff = 2.83 cfs @ 12.11 hrs, Volume= 9,341 cf, Depth= 2.47"

Runoff by SCS TR-20 method, UH=SCS, Weighted-CN, Time Span= 1.00-36.00 hrs, dt= 0.01 hrs  
Type III 24-hr 25-year Rainfall=5.80"

Area (sf)	CN	Description
* 9,176	98	Paved Impervious, HSG A
* 1,528	98	Paved Impervious, HSG B
3,894	98	Roofs, HSG A
8,917	98	Roofs, HSG B
12,216	39	>75% Grass cover, Good, HSG A
9,682	30	Woods, Good, HSG A
45,413	68	Weighted Average
21,898		48.22% Pervious Area
23,515		51.78% Impervious Area

Tc (min)	Length (feet)	Slope (ft/ft)	Velocity (ft/sec)	Capacity (cfs)	Description
6.4	50	0.1000	0.13		<b>Sheet Flow,</b> Woods: Light underbrush n= 0.400 P2= 3.30"
0.7	52	0.0570	1.19		<b>Shallow Concentrated Flow,</b> Woodland Kv= 5.0 fps
0.3	34	0.0580	1.69		<b>Shallow Concentrated Flow,</b> Short Grass Pasture Kv= 7.0 fps
7.4	136	Total			

**Cole Post-Development**

Prepared by Weston & Sampson

HydroCAD® 10.10-5a s/n 00455 © 2020 HydroCAD Software Solutions LLC

Type III 24-hr 25-year Rainfall=5.80"

Printed 7/12/2021

Page 64

**Subcatchment A8: SUB-A8**

Hydrograph

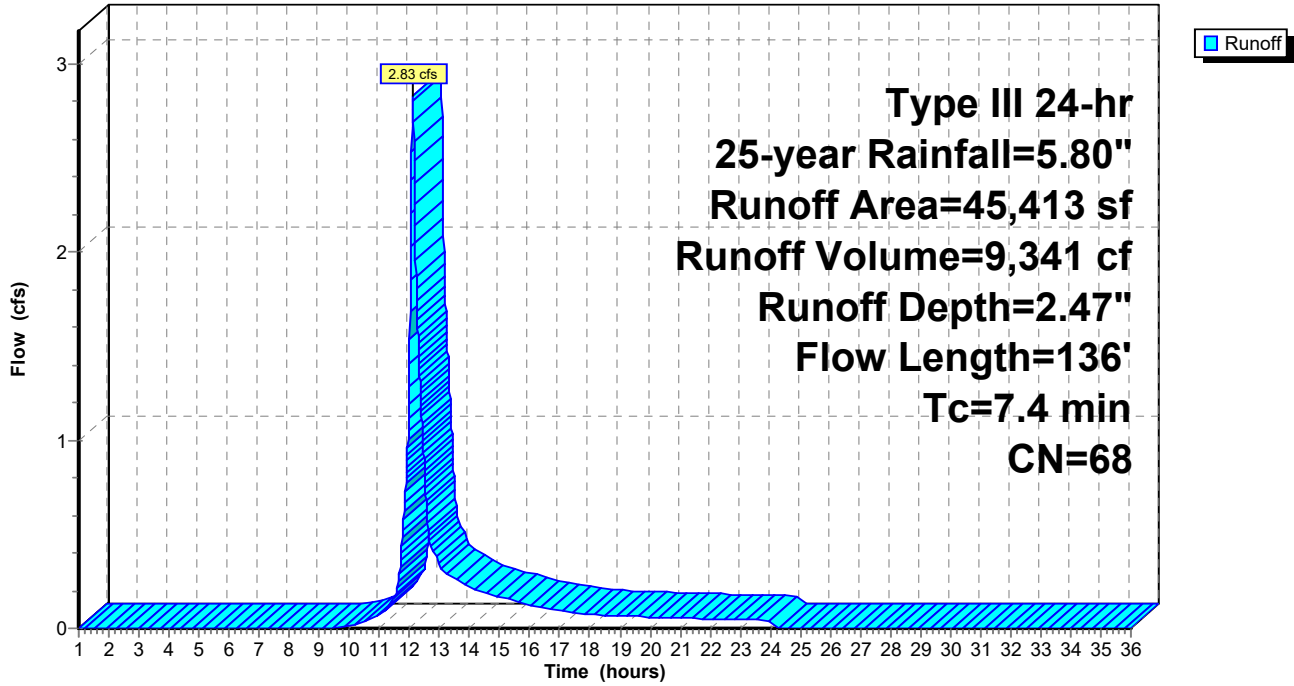

# Cole Post-Development

Prepared by Weston & Sampson

HydroCAD® 10.10-5a s/n 00455 © 2020 HydroCAD Software Solutions LLC

Type III 24-hr 25-year Rainfall=5.80"

Printed 7/12/2021

Page 65

## Summary for Subcatchment B1: SUB-B1

Runoff = 0.27 cfs @ 12.10 hrs, Volume= 882 cf, Depth= 1.79"

Runoff by SCS TR-20 method, UH=SCS, Weighted-CN, Time Span= 1.00-36.00 hrs, dt= 0.01 hrs  
Type III 24-hr 25-year Rainfall=5.80"

Area (sf)	CN	Description
5,112	61	>75% Grass cover, Good, HSG B
795	55	Woods, Good, HSG B
5,907	60	Weighted Average
5,907		100.00% Pervious Area

Tc (min)	Length (feet)	Slope (ft/ft)	Velocity (ft/sec)	Capacity (cfs)	Description
6.0					Direct Entry,

## Subcatchment B1: SUB-B1

Hydrograph

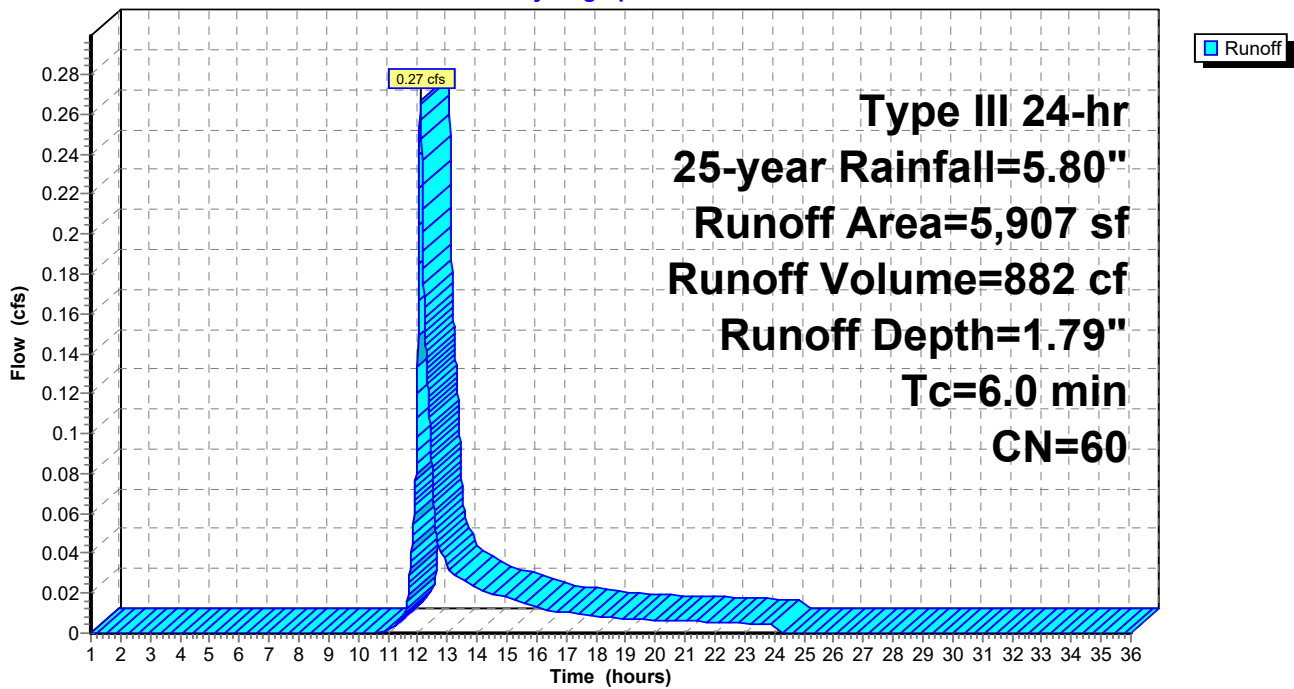

# Cole Post-Development

Prepared by Weston & Sampson

HydroCAD® 10.10-5a s/n 00455 © 2020 HydroCAD Software Solutions LLC

Type III 24-hr 25-year Rainfall=5.80"

Printed 7/12/2021

Page 66

## Summary for Pond A: POI-A

Inflow Area = 296,839 sf, 54.99% Impervious, Inflow Depth = 2.59" for 25-year event  
Inflow = 16.32 cfs @ 12.10 hrs, Volume= 64,044 cf  
Primary = 16.32 cfs @ 12.10 hrs, Volume= 64,044 cf, Atten= 0%, Lag= 0.0 min

Routing by Dyn-Stor-Ind method, Time Span= 1.00-36.00 hrs, dt= 0.01 hrs

### Pond A: POI-A

Hydrograph

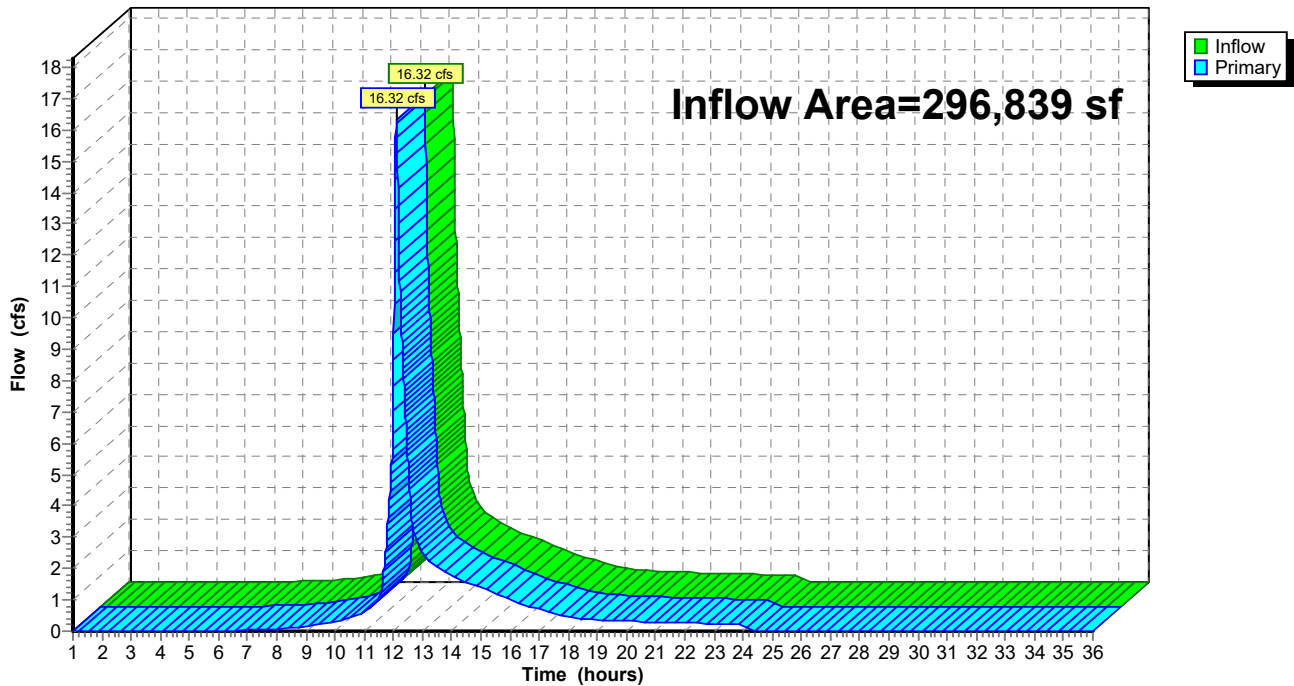

# Cole Post-Development

Prepared by Weston & Sampson

HydroCAD® 10.10-5a s/n 00455 © 2020 HydroCAD Software Solutions LLC

Type III 24-hr 25-year Rainfall=5.80"

Printed 7/12/2021

Page 67

## Summary for Pond B: POI-B

Inflow Area = 5,907 sf, 0.00% Impervious, Inflow Depth = 1.79" for 25-year event  
Inflow = 0.27 cfs @ 12.10 hrs, Volume= 882 cf  
Primary = 0.27 cfs @ 12.10 hrs, Volume= 882 cf, Atten= 0%, Lag= 0.0 min

Routing by Dyn-Stor-Ind method, Time Span= 1.00-36.00 hrs, dt= 0.01 hrs

### Pond B: POI-B

Hydrograph

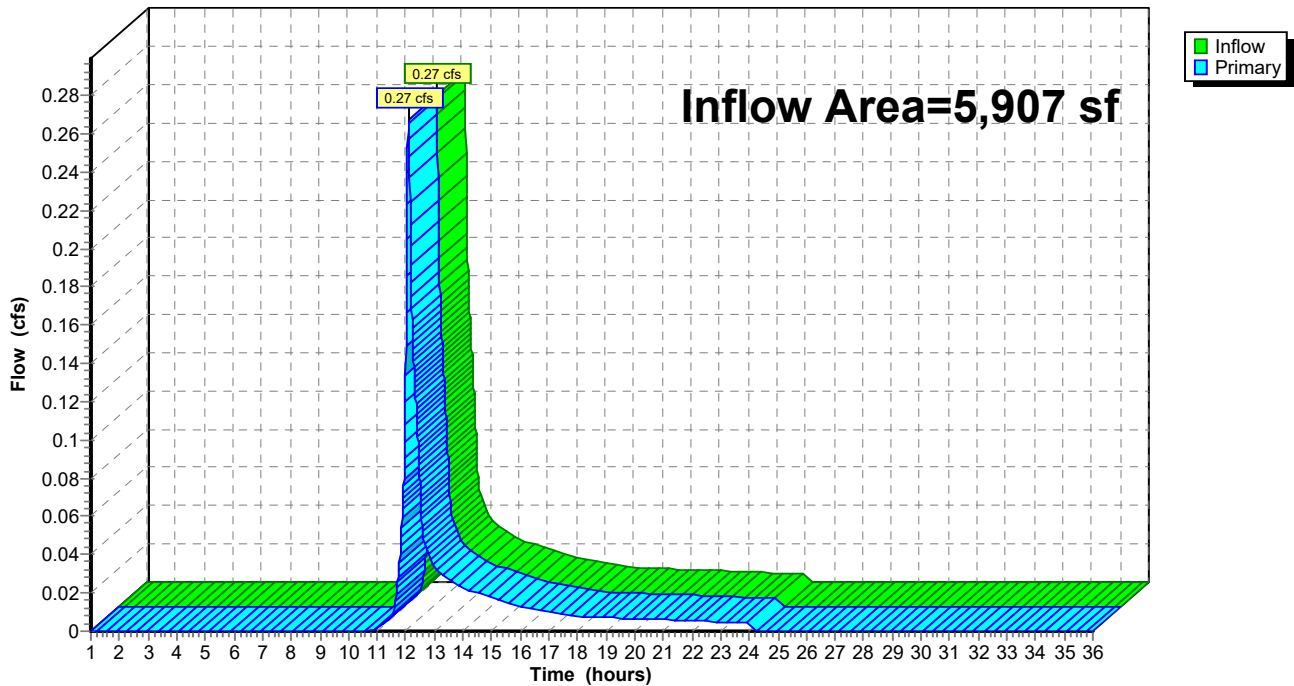

**Cole Post-Development**

Prepared by Weston & Sampson

HydroCAD® 10.10-5a s/n 00455 © 2020 HydroCAD Software Solutions LLC

Type III 24-hr 25-year Rainfall=5.80"

Printed 7/12/2021

Page 68

**Summary for Pond BR-1: BR-1**

Inflow Area = 16,500 sf, 77.45% Impervious, Inflow Depth = 4.22" for 25-year event  
 Inflow = 1.83 cfs @ 12.09 hrs, Volume= 5,802 cf  
 Outflow = 1.76 cfs @ 12.11 hrs, Volume= 4,992 cf, Atten= 4%, Lag= 1.6 min  
 Primary = 1.11 cfs @ 12.11 hrs, Volume= 4,828 cf  
 Secondary = 0.65 cfs @ 12.11 hrs, Volume= 163 cf

Routing by Dyn-Stor-Ind method, Time Span= 1.00-36.00 hrs, dt= 0.01 hrs  
 Peak Elev= 101.32' @ 12.11 hrs Surf.Area= 464 sf Storage= 1,005 cf

Plug-Flow detention time= 94.4 min calculated for 4,990 cf (86% of inflow)  
 Center-of-Mass det. time= 33.5 min ( 832.4 - 798.9 )

Volume	Invert	Avail.Storage	Storage Description	
#1	96.74'	1,245 cf	<b>Custom Stage Data (Prismatic)</b> Listed below (Recalc)	
Elevation (feet)	Surf.Area (sq-ft)	Voids (%)	Inc.Store (cubic-feet)	Cum.Store (cubic-feet)
96.74	641	0.0	0	0
96.75	641	40.0	3	3
97.24	641	40.0	126	128
97.25	641	30.0	2	130
100.24	641	30.0	575	705
100.25	641	40.0	3	708
100.49	641	40.0	62	769
100.50	88	100.0	4	773
101.00	335	100.0	106	879
101.75	641	100.0	366	1,245

Device	Routing	Invert	Outlet Devices
#1	Device 2	100.75'	<b>24.0" Horiz. Orifice/Grate</b> C= 0.600 Limited to weir flow at low heads
#2	Primary	94.49'	<b>12.0" Round Culvert</b> L= 62.8' CPP, projecting, no headwall, Ke= 0.900 Inlet / Outlet Invert= 94.49' / 94.18' S= 0.0049 '/' Cc= 0.900 n= 0.130, Flow Area= 0.79 sf
#3	Secondary	101.25'	<b>15.0' long x 10.0' breadth Broad-Crested Rectangular Weir</b> Head (feet) 0.20 0.40 0.60 0.80 1.00 1.20 1.40 1.60 Coef. (English) 2.49 2.56 2.70 2.69 2.68 2.69 2.67 2.64

**Primary OutFlow** Max=1.11 cfs @ 12.11 hrs HW=101.32' TW=94.97' (Dynamic Tailwater)

↑ **2=Culvert** (Barrel Controls 1.11 cfs @ 1.41 fps)

↑ **1=Orifice/Grate** (Passes 1.11 cfs of 8.76 cfs potential flow)

**Secondary OutFlow** Max=0.64 cfs @ 12.11 hrs HW=101.32' TW=94.97' (Dynamic Tailwater)

↑ **3=Broad-Crested Rectangular Weir** (Weir Controls 0.64 cfs @ 0.64 fps)



# Cole Post-Development

Prepared by Weston & Sampson

HydroCAD® 10.10-5a s/n 00455 © 2020 HydroCAD Software Solutions LLC

Type III 24-hr 25-year Rainfall=5.80"

Printed 7/12/2021

Page 69

## Pond BR-1: BR-1

Hydrograph

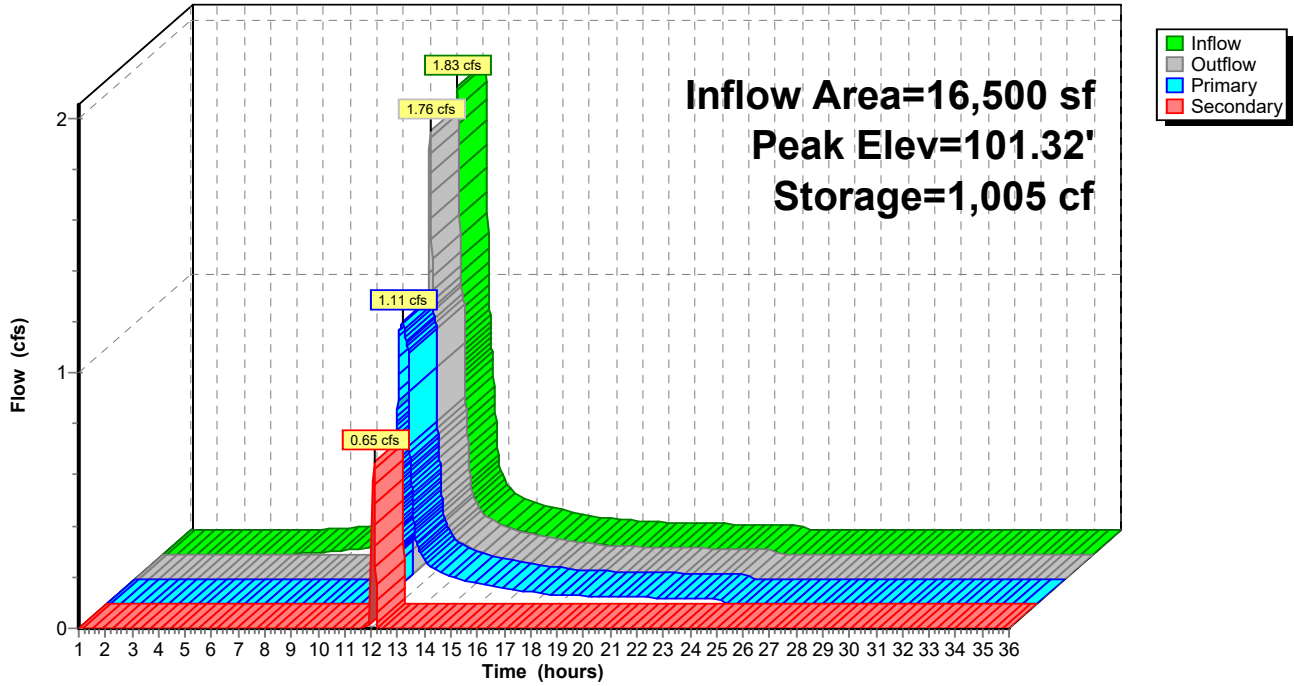

# Cole Post-Development

Prepared by Weston & Sampson

HydroCAD® 10.10-5a s/n 00455 © 2020 HydroCAD Software Solutions LLC

Type III 24-hr 25-year Rainfall=5.80"

Printed 7/12/2021

Page 70

## Summary for Pond DS-1: DS-1

Inflow Area = 35,193 sf, 61.85% Impervious, Inflow Depth = 3.31" for 25-year event  
 Inflow = 2.83 cfs @ 12.13 hrs, Volume= 9,693 cf  
 Outflow = 2.82 cfs @ 12.14 hrs, Volume= 9,692 cf, Atten= 1%, Lag= 0.7 min  
 Primary = 2.82 cfs @ 12.14 hrs, Volume= 9,692 cf

Routing by Dyn-Stor-Ind method, Time Span= 1.00-36.00 hrs, dt= 0.01 hrs  
 Peak Elev= 90.28' @ 12.14 hrs Surf.Area= 658 sf Storage= 880 cf

Plug-Flow detention time= 18.8 min calculated for 9,692 cf (100% of inflow)  
 Center-of-Mass det. time= 18.7 min ( 844.4 - 825.8 )

Volume	Invert	Avail.Storage	Storage Description
#1A	88.25'	627 cf	<b>20.50'W x 32.10'L x 3.50'H Field A</b> 2,303 cf Overall - 735 cf Embedded = 1,568 cf x 40.0% Voids
#2A	88.75'	735 cf	<b>ADS_StormTech SC-740 +Cap</b> x 16 Inside #1 Effective Size= 44.6"W x 30.0"H => 6.45 sf x 7.12'L = 45.9 cf Overall Size= 51.0"W x 30.0"H x 7.56'L with 0.44' Overlap 16 Chambers in 4 Rows
		1,362 cf	Total Available Storage

Storage Group A created with Chamber Wizard

Device	Routing	Invert	Outlet Devices
#1	Primary	88.25'	<b>24.0" Round Culvert</b> L= 26.9' CPP, projecting, no headwall, Ke= 0.900 Inlet / Outlet Invert= 88.25' / 88.12' S= 0.0048 '/ Cc= 0.900 n= 0.013 Corrugated PE, smooth interior, Flow Area= 3.14 sf
#2	Device 1	89.95'	<b>4.0' long Sharp-Crested Rectangular Weir</b> 2 End Contraction(s)
#3	Device 1	88.25'	<b>3.0" Vert. Orifice/Grate</b> C= 0.600 Limited to weir flow at low heads

**Primary OutFlow** Max=2.81 cfs @ 12.14 hrs HW=90.28' TW=0.00' (Dynamic Tailwater)

↑ **1=Culvert** (Passes 2.81 cfs of 11.22 cfs potential flow)

↑ **2=Sharp-Crested Rectangular Weir** (Weir Controls 2.49 cfs @ 1.89 fps)

↑ **3=Orifice/Grate** (Orifice Controls 0.33 cfs @ 6.65 fps)

**Cole Post-Development**

Prepared by Weston & Sampson

HydroCAD® 10.10-5a s/n 00455 © 2020 HydroCAD Software Solutions LLC

Type III 24-hr 25-year Rainfall=5.80"

Printed 7/12/2021

Page 71

**Pond DS-1: DS-1 - Chamber Wizard Field A**

**Chamber Model = ADS\_StormTechSC-740 +Cap (ADS StormTech®SC-740 with cap length)**

Effective Size= 44.6"W x 30.0"H => 6.45 sf x 7.12'L = 45.9 cf

Overall Size= 51.0"W x 30.0"H x 7.56'L with 0.44' Overlap

51.0" Wide + 6.0" Spacing = 57.0" C-C Row Spacing

4 Chambers/Row x 7.12' Long +0.81' Cap Length x 2 = 30.10' Row Length +12.0" End Stone x 2 = 32.10' Base Length

4 Rows x 51.0" Wide + 6.0" Spacing x 3 + 12.0" Side Stone x 2 = 20.50' Base Width

6.0" Stone Base + 30.0" Chamber Height + 6.0" Stone Cover = 3.50' Field Height

16 Chambers x 45.9 cf = 735.0 cf Chamber Storage

2,302.9 cf Field - 735.0 cf Chambers = 1,567.9 cf Stone x 40.0% Voids = 627.2 cf Stone Storage

Chamber Storage + Stone Storage = 1,362.2 cf = 0.031 af

Overall Storage Efficiency = 59.2%

Overall System Size = 32.10' x 20.50' x 3.50'

16 Chambers

85.3 cy Field

58.1 cy Stone

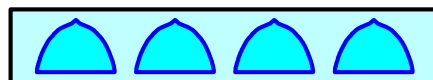
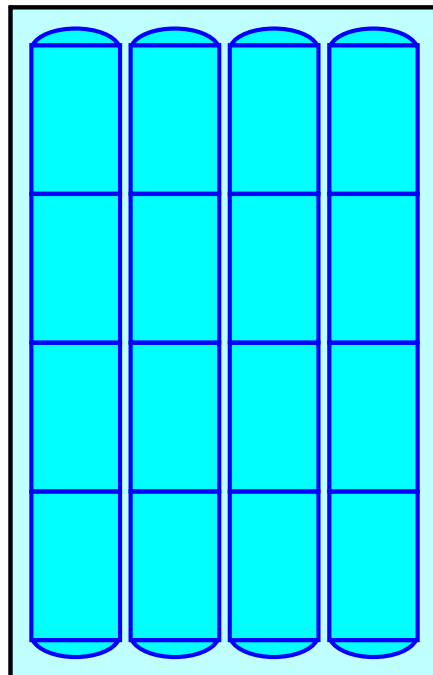

# Cole Post-Development

Prepared by Weston & Sampson

HydroCAD® 10.10-5a s/n 00455 © 2020 HydroCAD Software Solutions LLC

Type III 24-hr 25-year Rainfall=5.80"

Printed 7/12/2021

Page 72

## Pond DS-1: DS-1

### Hydrograph

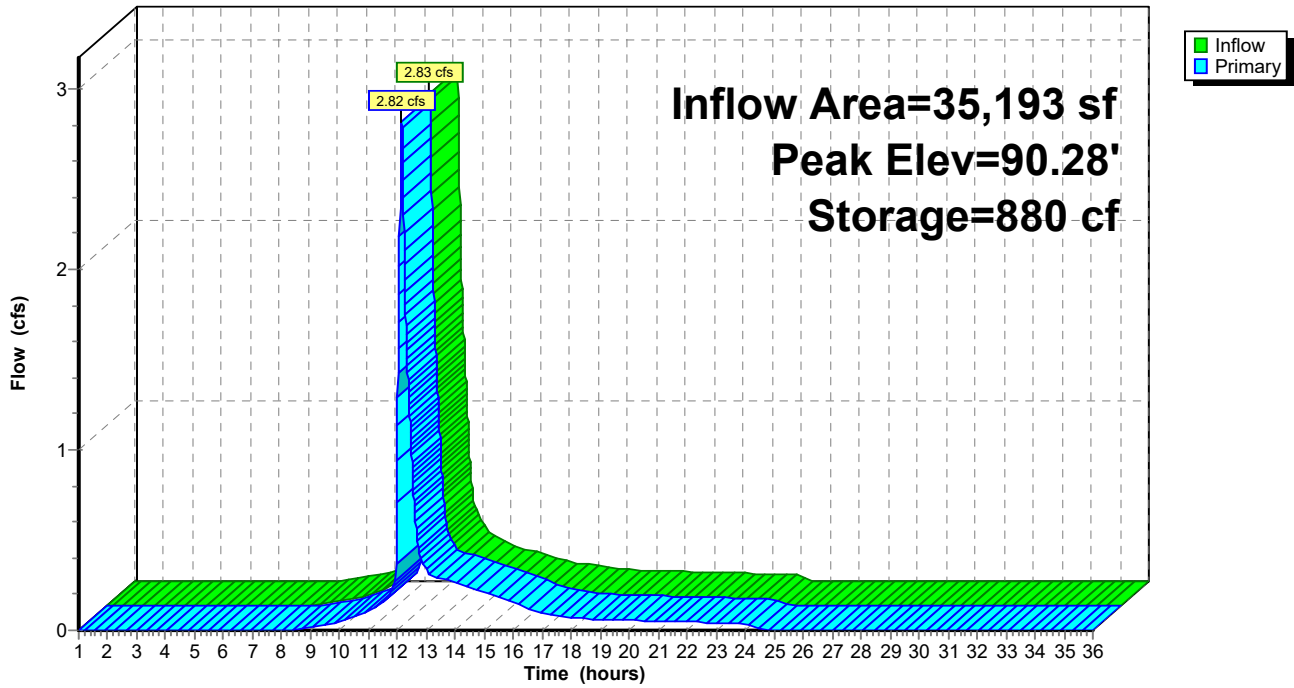

# Cole Post-Development

Prepared by Weston & Sampson

HydroCAD® 10.10-5a s/n 00455 © 2020 HydroCAD Software Solutions LLC

Type III 24-hr 25-year Rainfall=5.80"

Printed 7/12/2021

Page 73

## Summary for Pond IS-1: IS-1

Inflow Area = 61,597 sf, 85.38% Impervious, Inflow Depth = 4.54" for 25-year event  
Inflow = 7.14 cfs @ 12.10 hrs, Volume= 23,305 cf  
Outflow = 0.89 cfs @ 12.68 hrs, Volume= 23,305 cf, Atten= 88%, Lag= 34.6 min  
Discarded = 0.27 cfs @ 12.68 hrs, Volume= 14,982 cf  
Primary = 0.62 cfs @ 12.68 hrs, Volume= 8,323 cf

Routing by Dyn-Stor-Ind method, Time Span= 1.00-36.00 hrs, dt= 0.01 hrs  
Peak Elev= 96.54' @ 12.68 hrs Surf.Area= 3,603 sf Storage= 10,035 cf

Plug-Flow detention time= 164.8 min calculated for 23,298 cf (100% of inflow)  
Center-of-Mass det. time= 164.8 min ( 954.6 - 789.8 )

Volume	Invert	Avail.Storage	Storage Description
#1A	92.50'	5,063 cf	<b>29.92'W x 120.42'L x 5.50'H Field A</b> 19,814 cf Overall - 7,156 cf Embedded = 12,658 cf x 40.0% Voids
#2A	93.25'	7,156 cf	<b>ADS_StormTech MC-3500 d +Capx 64</b> Inside #1 Effective Size= 70.4"W x 45.0"H => 15.33 sf x 7.17'L = 110.0 cf Overall Size= 77.0"W x 45.0"H x 7.50'L with 0.33' Overlap 64 Chambers in 4 Rows Cap Storage= +14.9 cf x 2 x 4 rows = 119.2 cf
		12,219 cf	Total Available Storage

Storage Group A created with Chamber Wizard

Device	Routing	Invert	Outlet Devices
#1	Discarded	92.50'	<b>2.410 in/hr Exfiltration over Wetted area</b> Phase-In= 0.01'
#2	Primary	92.00'	<b>12.0" Round Culvert</b> L= 91.3' CPP, projecting, no headwall, Ke= 0.900 Inlet / Outlet Invert= 92.00' / 91.09' S= 0.0100 '/ Cc= 0.900 n= 0.013 Corrugated PE, smooth interior, Flow Area= 0.79 sf
#3	Device 2	97.00'	<b>4.0' long Sharp-Crested Rectangular Weir</b> 2 End Contraction(s)
#4	Device 2	94.20'	<b>4.0" Vert. Orifice/Grate</b> C= 0.600 Limited to weir flow at low heads

**Discarded OutFlow** Max=0.27 cfs @ 12.68 hrs HW=96.54' (Free Discharge)

↑ **1=Exfiltration** (Exfiltration Controls 0.27 cfs)

**Primary OutFlow** Max=0.62 cfs @ 12.68 hrs HW=96.54' TW=0.00' (Dynamic Tailwater)

↑ **2=Culvert** (Passes 0.62 cfs of 6.00 cfs potential flow)

↑ **3=Sharp-Crested Rectangular Weir** ( Controls 0.00 cfs)

↑ **4=Orifice/Grate** (Orifice Controls 0.62 cfs @ 7.10 fps)

**Cole Post-Development**

Prepared by Weston & Sampson

HydroCAD® 10.10-5a s/n 00455 © 2020 HydroCAD Software Solutions LLC

Type III 24-hr 25-year Rainfall=5.80"

Printed 7/12/2021

Page 74

**Pond IS-1: IS-1 - Chamber Wizard Field A**

**Chamber Model = ADS\_StormTechMC-3500 d +Cap (ADS StormTech®MC-3500 d rev 03/14 with Cap volume)**

Effective Size= 70.4"W x 45.0"H => 15.33 sf x 7.17'L = 110.0 cf

Overall Size= 77.0"W x 45.0"H x 7.50'L with 0.33' Overlap

Cap Storage= +14.9 cf x 2 x 4 rows = 119.2 cf

77.0" Wide + 9.0" Spacing = 86.0" C-C Row Spacing

16 Chambers/Row x 7.17' Long +1.85' Cap Length x 2 = 118.42' Row Length +12.0" End Stone x 2 = 120.42' Base Length

4 Rows x 77.0" Wide + 9.0" Spacing x 3 + 12.0" Side Stone x 2 = 29.92' Base Width

9.0" Stone Base + 45.0" Chamber Height + 12.0" Stone Cover = 5.50' Field Height

64 Chambers x 110.0 cf + 14.9 cf Cap Volume x 2 x 4 Rows = 7,156.1 cf Chamber Storage

19,814.1 cf Field - 7,156.1 cf Chambers = 12,658.0 cf Stone x 40.0% Voids = 5,063.2 cf Stone Storage

Chamber Storage + Stone Storage = 12,219.3 cf = 0.281 af

Overall Storage Efficiency = 61.7%

Overall System Size = 120.42' x 29.92' x 5.50'

64 Chambers

733.9 cy Field

468.8 cy Stone

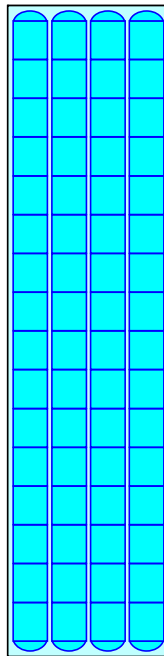

# Cole Post-Development

Prepared by Weston & Sampson

HydroCAD® 10.10-5a s/n 00455 © 2020 HydroCAD Software Solutions LLC

Type III 24-hr 25-year Rainfall=5.80"

Printed 7/12/2021

Page 75

## Pond IS-1: IS-1

Hydrograph

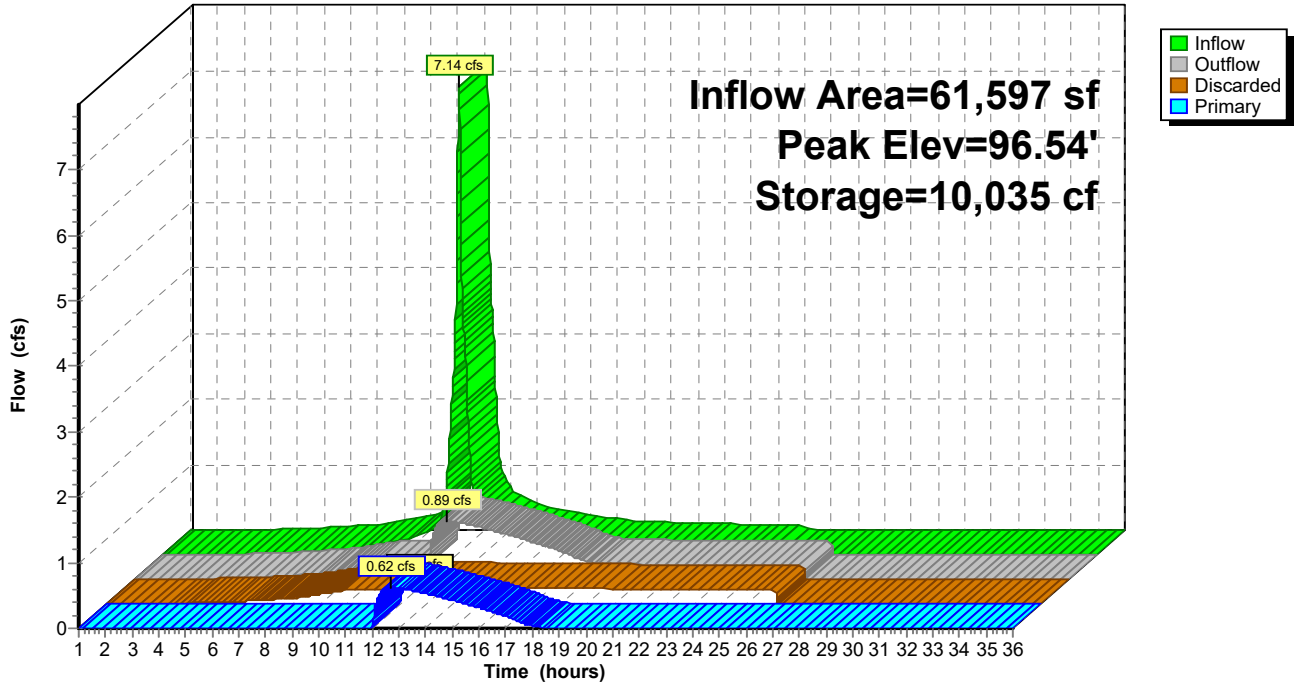

**Cole Post-Development**

Prepared by Weston &amp; Sampson

HydroCAD® 10.10-5a s/n 00455 © 2020 HydroCAD Software Solutions LLC

Type III 24-hr 50-year Rainfall=7.10"

Printed 7/12/2021

Page 76

Time span=1.00-36.00 hrs, dt=0.01 hrs, 3501 points  
 Runoff by SCS TR-20 method, UH=SCS, Weighted-CN  
 Reach routing by Dyn-Stor-Ind method - Pond routing by Dyn-Stor-Ind method

<b>SubcatchmentA1: SUB-A1</b>	Runoff Area=67,238 sf 64.49% Impervious Runoff Depth=5.35" Tc=6.0 min CN=85 Runoff=9.40 cfs 29,967 cf
<b>SubcatchmentA2: SUB-A2</b>	Runoff Area=35,193 sf 61.85% Impervious Runoff Depth=4.46" Flow Length=160' Tc=8.9 min CN=77 Runoff=3.81 cfs 13,068 cf
<b>SubcatchmentA3: SUB-A3</b>	Runoff Area=16,500 sf 77.45% Impervious Runoff Depth=5.46" Tc=6.0 min CN=86 Runoff=2.34 cfs 7,510 cf
<b>SubcatchmentA4: SUB-A4</b>	Runoff Area=45,097 sf 88.28% Impervious Runoff Depth=6.15" Tc=6.0 min CN=92 Runoff=6.92 cfs 23,125 cf
<b>SubcatchmentA5: SUB-A2</b>	Runoff Area=11,510 sf 59.26% Impervious Runoff Depth=4.13" Tc=6.0 min CN=74 Runoff=1.28 cfs 3,961 cf
<b>SubcatchmentA6: SUB-A4</b>	Runoff Area=44,811 sf 26.24% Impervious Runoff Depth=2.48" Flow Length=463' Tc=12.7 min CN=58 Runoff=2.30 cfs 9,251 cf
<b>SubcatchmentA7: SUB-A7</b>	Runoff Area=31,077 sf 11.00% Impervious Runoff Depth=2.67" Tc=6.0 min CN=60 Runoff=2.18 cfs 6,927 cf
<b>SubcatchmentA8: SUB-A8</b>	Runoff Area=45,413 sf 51.78% Impervious Runoff Depth=3.49" Flow Length=136' Tc=7.4 min CN=68 Runoff=4.05 cfs 13,212 cf
<b>SubcatchmentB1: SUB-B1</b>	Runoff Area=5,907 sf 0.00% Impervious Runoff Depth=2.67" Tc=6.0 min CN=60 Runoff=0.41 cfs 1,317 cf
<b>Pond A: POI-A</b>	Inflow=22.52 cfs 89,745 cf Primary=22.52 cfs 89,745 cf
<b>Pond B: POI-B</b>	Inflow=0.41 cfs 1,317 cf Primary=0.41 cfs 1,317 cf
<b>Pond BR-1: BR-1</b>	Peak Elev=101.35' Storage=1,023 cf Inflow=2.34 cfs 7,510 cf Primary=1.11 cfs 6,105 cf Secondary=1.25 cfs 595 cf Outflow=2.33 cfs 6,700 cf
<b>Pond DS-1: DS-1</b>	Peak Elev=90.37' Storage=916 cf Inflow=3.81 cfs 13,068 cf Outflow=3.79 cfs 13,067 cf
<b>Pond IS-1: IS-1</b>	Peak Elev=97.35' Storage=11,276 cf Inflow=9.24 cfs 29,825 cf Discarded=0.28 cfs 16,466 cf Primary=3.33 cfs 13,360 cf Outflow=3.61 cfs 29,825 cf

**Total Runoff Area = 302,746 sf Runoff Volume = 108,338 cf Average Runoff Depth = 4.29"**  
**46.08% Pervious = 139,512 sf 53.92% Impervious = 163,234 sf**



# Cole Post-Development

Prepared by Weston & Sampson

HydroCAD® 10.10-5a s/n 00455 © 2020 HydroCAD Software Solutions LLC

Type III 24-hr 50-year Rainfall=7.10"

Printed 7/12/2021

Page 77

## Summary for Subcatchment A1: SUB-A1

Runoff = 9.40 cfs @ 12.09 hrs, Volume= 29,967 cf, Depth= 5.35"

Runoff by SCS TR-20 method, UH=SCS, Weighted-CN, Time Span= 1.00-36.00 hrs, dt= 0.01 hrs  
Type III 24-hr 50-year Rainfall=7.10"

	Area (sf)	CN	Description
*	27,200	98	Paved Impervious, HSG B
	16,163	98	Roofs, HSG B
	23,006	61	>75% Grass cover, Good, HSG B
	869	55	Woods, Good, HSG B
<hr/>			
	67,238	85	Weighted Average
	23,875		35.51% Pervious Area
	43,363		64.49% Impervious Area

Tc (min)	Length (feet)	Slope (ft/ft)	Velocity (ft/sec)	Capacity (cfs)	Description
6.0					Direct Entry,

## Subcatchment A1: SUB-A1

Hydrograph

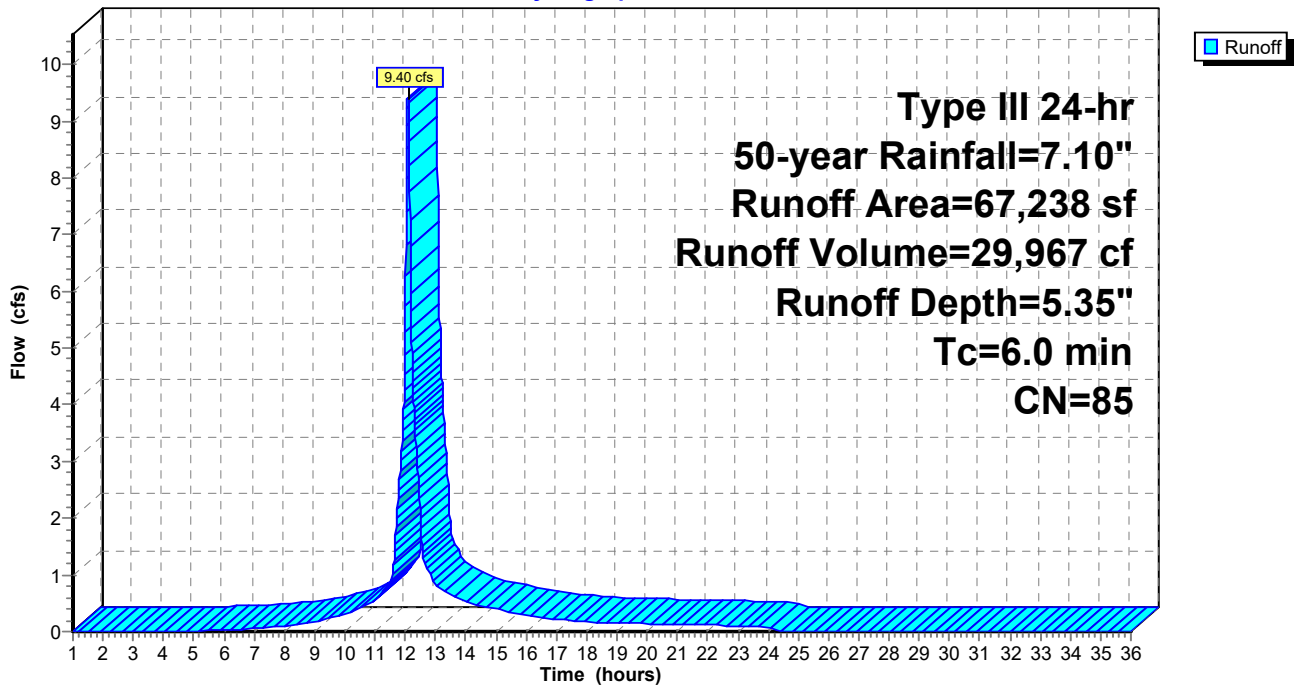

**Cole Post-Development**

Prepared by Weston & Sampson

HydroCAD® 10.10-5a s/n 00455 © 2020 HydroCAD Software Solutions LLC

Type III 24-hr 50-year Rainfall=7.10"

Printed 7/12/2021

Page 78

**Summary for Subcatchment A2: SUB-A2**

Runoff = 3.81 cfs @ 12.12 hrs, Volume= 13,068 cf, Depth= 4.46"

Runoff by SCS TR-20 method, UH=SCS, Weighted-CN, Time Span= 1.00-36.00 hrs, dt= 0.01 hrs  
Type III 24-hr 50-year Rainfall=7.10"

Area (sf)	CN	Description
* 23	98	Paved Impervious, HSG A
* 18,246	98	Paved Impervious, HSG B
3,498	98	Roofs, HSG B
1,694	39	>75% Grass cover, Good, HSG A
4,693	61	>75% Grass cover, Good, HSG B
6,952	30	Woods, Good, HSG A
87	55	Woods, Good, HSG B
35,193	77	Weighted Average
13,426		38.15% Pervious Area
21,767		61.85% Impervious Area

Tc (min)	Length (feet)	Slope (ft/ft)	Velocity (ft/sec)	Capacity (cfs)	Description
7.4	50	0.0700	0.11		<b>Sheet Flow,</b> Woods: Light underbrush n= 0.400 P2= 3.30"
0.5	33	0.0450	1.06		<b>Shallow Concentrated Flow,</b> Woodland Kv= 5.0 fps
0.9	59	0.0250	1.11		<b>Shallow Concentrated Flow,</b> Short Grass Pasture Kv= 7.0 fps
0.1	18	0.0150	2.49		<b>Shallow Concentrated Flow,</b> Paved Kv= 20.3 fps
8.9	160	Total			

**Cole Post-Development**

Prepared by Weston & Sampson

HydroCAD® 10.10-5a s/n 00455 © 2020 HydroCAD Software Solutions LLC

Type III 24-hr 50-year Rainfall=7.10"

Printed 7/12/2021

Page 79

**Subcatchment A2: SUB-A2**

Hydrograph

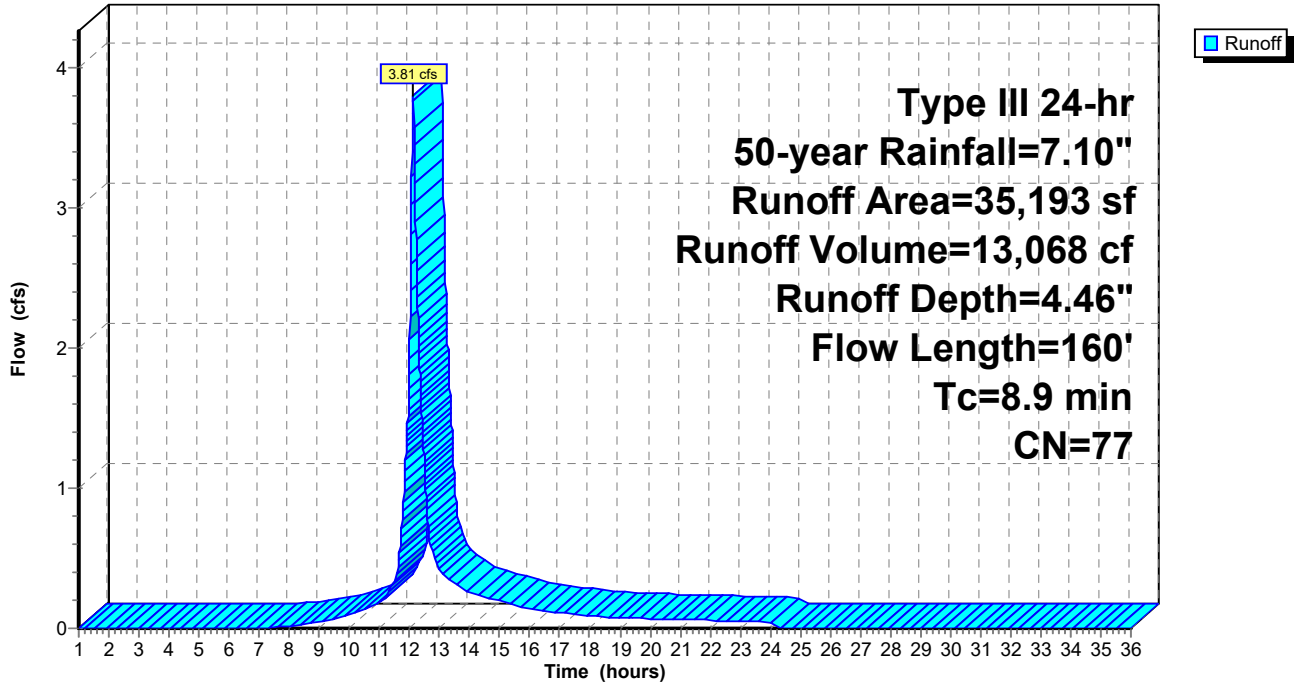

**Cole Post-Development**

Prepared by Weston & Sampson

HydroCAD® 10.10-5a s/n 00455 © 2020 HydroCAD Software Solutions LLC

Type III 24-hr 50-year Rainfall=7.10"

Printed 7/12/2021

Page 80

**Summary for Subcatchment A3: SUB-A3**

Runoff = 2.34 cfs @ 12.09 hrs, Volume= 7,510 cf, Depth= 5.46"

Runoff by SCS TR-20 method, UH=SCS, Weighted-CN, Time Span= 1.00-36.00 hrs, dt= 0.01 hrs  
 Type III 24-hr 50-year Rainfall=7.10"

	Area (sf)	CN	Description
*	4,196	98	Paved Impervious, HSG A
*	1,717	98	Paved Impervious, HSG B
	6,866	98	Roofs, HSG B
	2,808	39	>75% Grass cover, Good, HSG A
	913	61	>75% Grass cover, Good, HSG B
	16,500	86	Weighted Average
	3,721		22.55% Pervious Area
	12,779		77.45% Impervious Area

Tc (min)	Length (feet)	Slope (ft/ft)	Velocity (ft/sec)	Capacity (cfs)	Description
6.0					Direct Entry,

**Subcatchment A3: SUB-A3**

Hydrograph

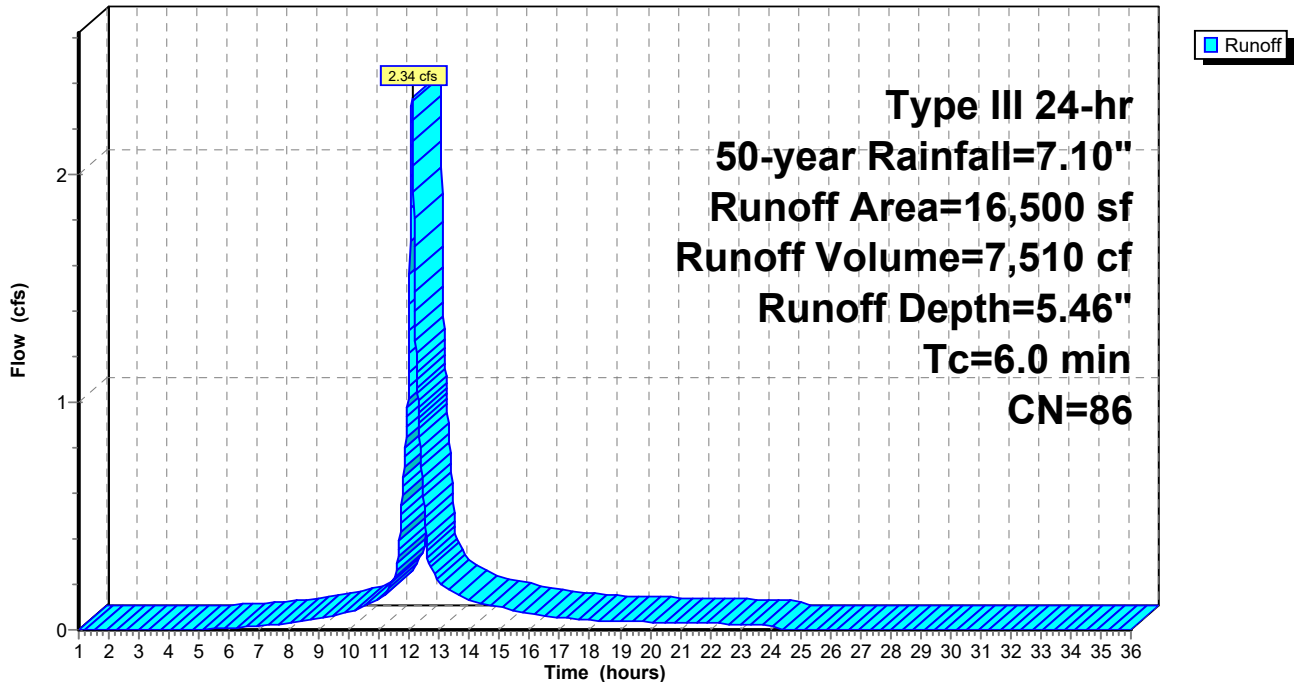

**Cole Post-Development**

Prepared by Weston & Sampson

HydroCAD® 10.10-5a s/n 00455 © 2020 HydroCAD Software Solutions LLC

Type III 24-hr 50-year Rainfall=7.10"

Printed 7/12/2021

Page 81

**Summary for Subcatchment A4: SUB-A4**

Runoff = 6.92 cfs @ 12.08 hrs, Volume= 23,125 cf, Depth= 6.15"

Runoff by SCS TR-20 method, UH=SCS, Weighted-CN, Time Span= 1.00-36.00 hrs, dt= 0.01 hrs  
Type III 24-hr 50-year Rainfall=7.10"

	Area (sf)	CN	Description
*	28,479	98	Paved Impervious, HSG A
*	4,701	98	Paved Impervious, HSG B
	3,540	98	Roofs, HSG A
	3,092	98	Roofs, HSG B
	3,675	39	>75% Grass cover, Good, HSG A
	1,610	61	>75% Grass cover, Good, HSG B
	45,097	92	Weighted Average
	5,285		11.72% Pervious Area
	39,812		88.28% Impervious Area

Tc (min)	Length (feet)	Slope (ft/ft)	Velocity (ft/sec)	Capacity (cfs)	Description
6.0					Direct Entry,

**Subcatchment A4: SUB-A4**

Hydrograph

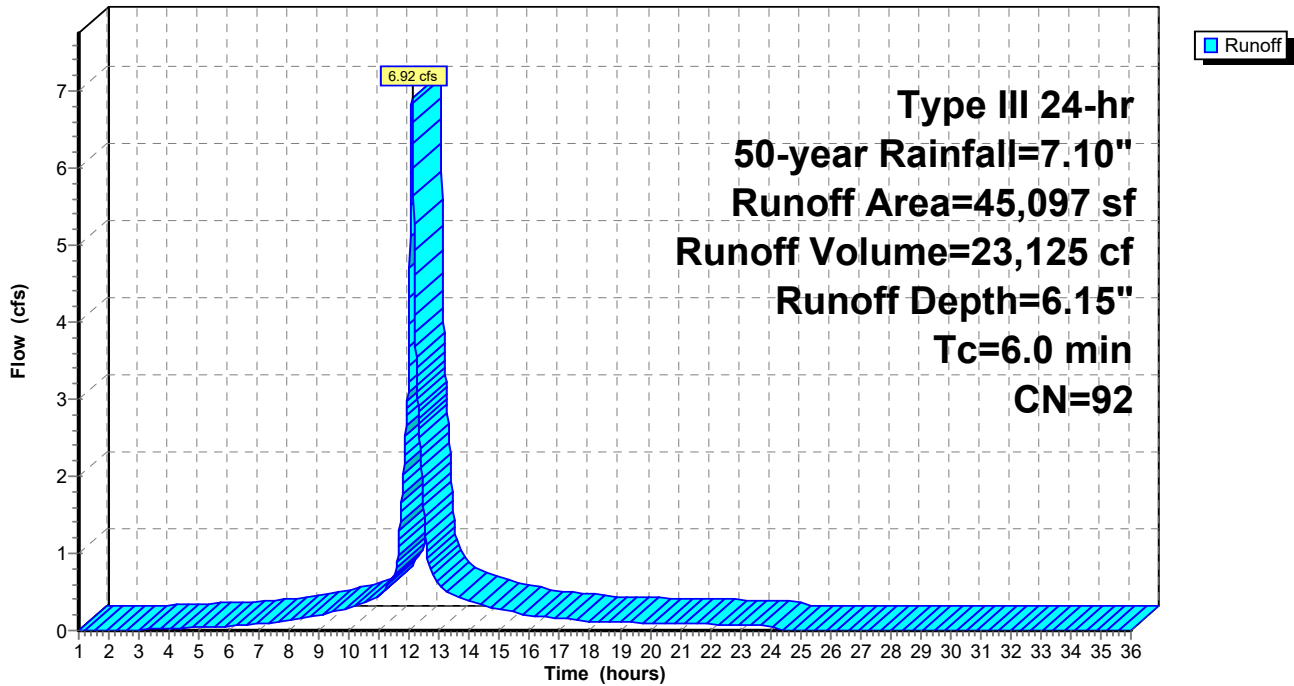

**Cole Post-Development**

Prepared by Weston & Sampson

HydroCAD® 10.10-5a s/n 00455 © 2020 HydroCAD Software Solutions LLC

Type III 24-hr 50-year Rainfall=7.10"

Printed 7/12/2021

Page 82

**Summary for Subcatchment A5: SUB-A2**

Runoff = 1.28 cfs @ 12.09 hrs, Volume= 3,961 cf, Depth= 4.13"

Runoff by SCS TR-20 method, UH=SCS, Weighted-CN, Time Span= 1.00-36.00 hrs, dt= 0.01 hrs  
Type III 24-hr 50-year Rainfall=7.10"

	Area (sf)	CN	Description
*	5,725	98	Paved Impervious, HSG A
*	1,096	98	Paved Impervious, HSG B
	4,689	39	>75% Grass cover, Good, HSG A
	11,510	74	Weighted Average
	4,689		40.74% Pervious Area
	6,821		59.26% Impervious Area

Tc (min)	Length (feet)	Slope (ft/ft)	Velocity (ft/sec)	Capacity (cfs)	Description
6.0					Direct Entry,

**Subcatchment A5: SUB-A2**

Hydrograph

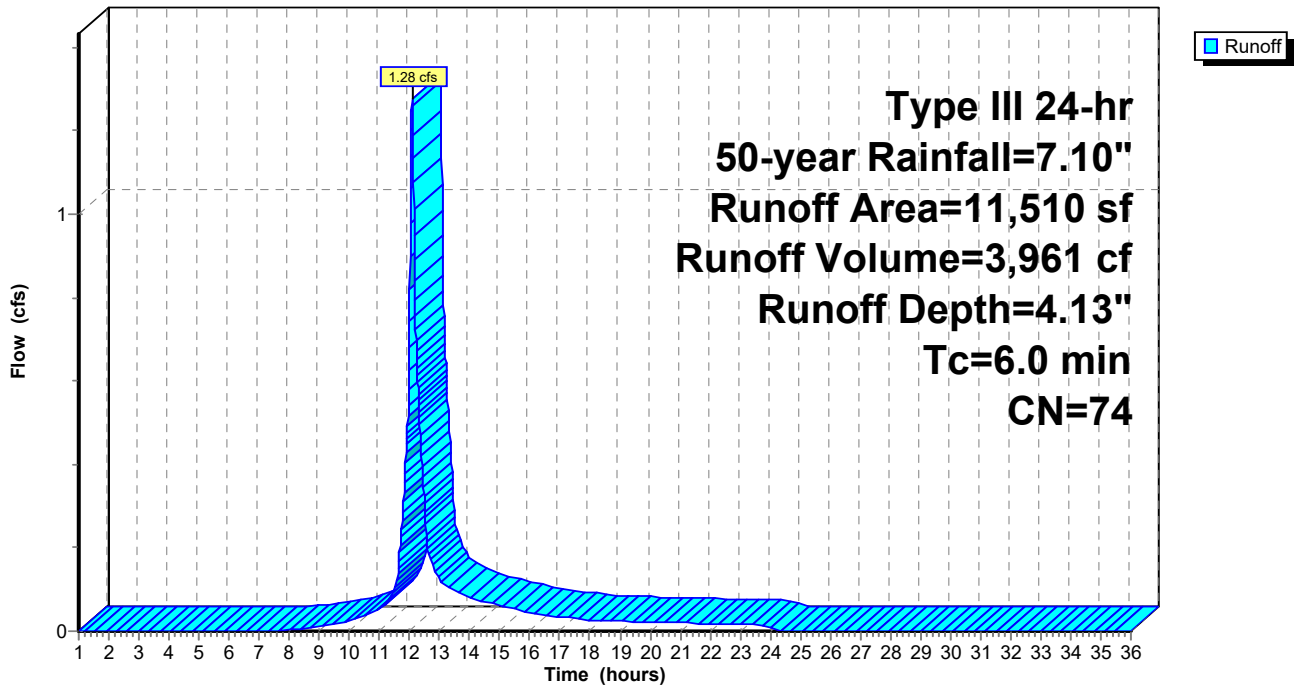

**Cole Post-Development**

Prepared by Weston & Sampson

HydroCAD® 10.10-5a s/n 00455 © 2020 HydroCAD Software Solutions LLC

Type III 24-hr 50-year Rainfall=7.10"

Printed 7/12/2021

Page 83

**Summary for Subcatchment A6: SUB-A4**

Runoff = 2.30 cfs @ 12.18 hrs, Volume= 9,251 cf, Depth= 2.48"

Runoff by SCS TR-20 method, UH=SCS, Weighted-CN, Time Span= 1.00-36.00 hrs, dt= 0.01 hrs  
Type III 24-hr 50-year Rainfall=7.10"

Area (sf)	CN	Description
* 3,625	98	Paved Impervious, HSG A
* 8,132	98	Paved Impervious, HSG B
13,635	30	Woods, Good, HSG A
13,102	55	Woods, Good, HSG B
2,357	39	>75% Grass cover, Good, HSG A
3,960	61	>75% Grass cover, Good, HSG B
44,811	58	Weighted Average
33,054		73.76% Pervious Area
11,757		26.24% Impervious Area

Tc (min)	Length (feet)	Slope (ft/ft)	Velocity (ft/sec)	Capacity (cfs)	Description
7.8	50	0.0600	0.11		<b>Sheet Flow,</b> Woods: Light underbrush n= 0.400 P2= 3.30"
2.5	120	0.0250	0.79		<b>Shallow Concentrated Flow,</b> Woodland Kv= 5.0 fps
2.4	293	0.0100	2.03		<b>Shallow Concentrated Flow,</b> Paved Kv= 20.3 fps
12.7	463	Total			

**Subcatchment A6: SUB-A4**

Hydrograph

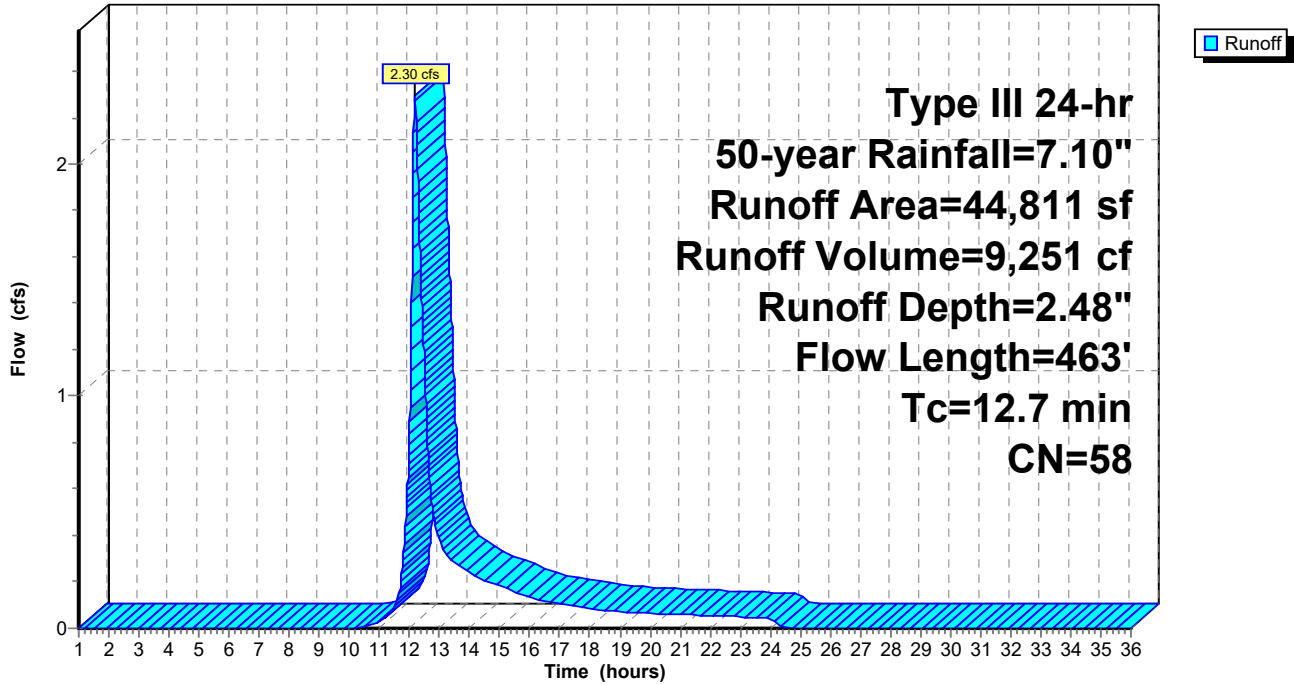



**Cole Post-Development**

Prepared by Weston & Sampson

HydroCAD® 10.10-5a s/n 00455 © 2020 HydroCAD Software Solutions LLC

Type III 24-hr 50-year Rainfall=7.10"

Printed 7/12/2021

Page 85

**Summary for Subcatchment A7: SUB-A7**

Runoff = 2.18 cfs @ 12.09 hrs, Volume= 6,927 cf, Depth= 2.67"

Runoff by SCS TR-20 method, UH=SCS, Weighted-CN, Time Span= 1.00-36.00 hrs, dt= 0.01 hrs  
Type III 24-hr 50-year Rainfall=7.10"

	Area (sf)	CN	Description
*	3,420	98	Paved Impervious, HSG B
	523	39	>75% Grass cover, Good, HSG A
	16,801	61	>75% Grass cover, Good, HSG B
	3,334	30	Woods, Good, HSG A
	6,999	55	Woods, Good, HSG B
	31,077	60	Weighted Average
	27,657		89.00% Pervious Area
	3,420		11.00% Impervious Area

Tc (min)	Length (feet)	Slope (ft/ft)	Velocity (ft/sec)	Capacity (cfs)	Description
6.0					Direct Entry,

**Subcatchment A7: SUB-A7**

Hydrograph

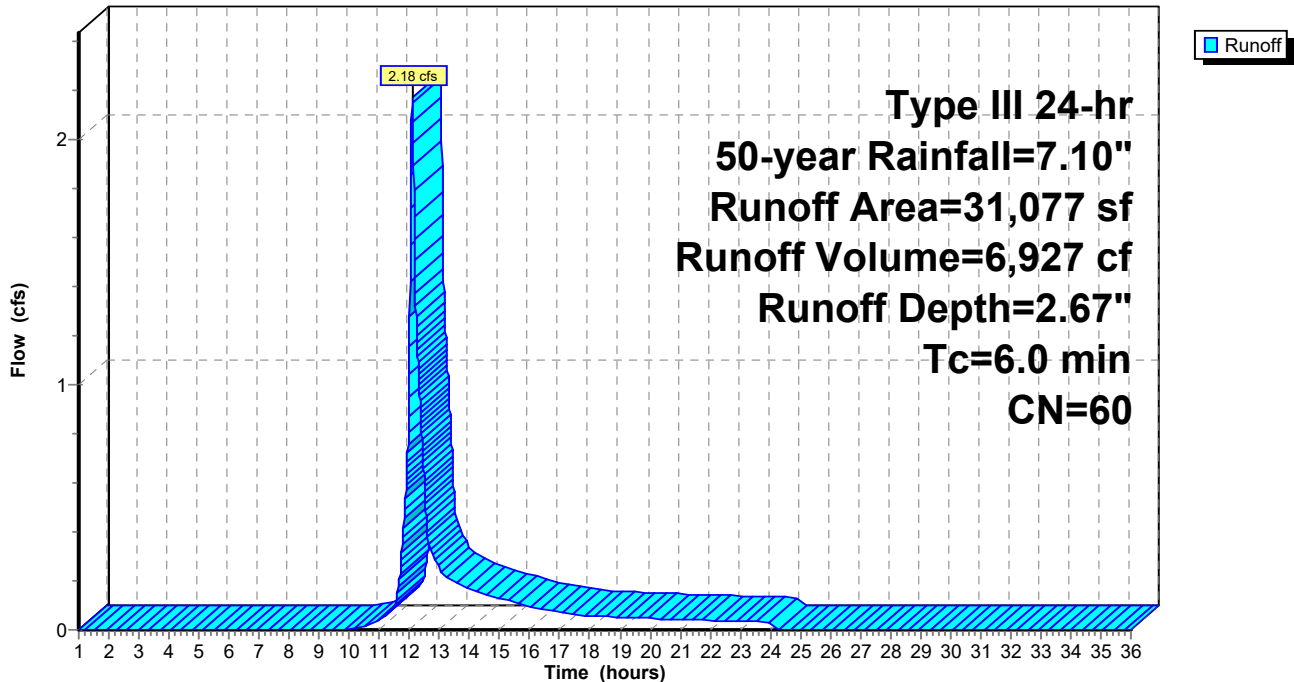

**Cole Post-Development**

Prepared by Weston & Sampson

HydroCAD® 10.10-5a s/n 00455 © 2020 HydroCAD Software Solutions LLC

Type III 24-hr 50-year Rainfall=7.10"

Printed 7/12/2021

Page 86

**Summary for Subcatchment A8: SUB-A8**

Runoff = 4.05 cfs @ 12.11 hrs, Volume= 13,212 cf, Depth= 3.49"

Runoff by SCS TR-20 method, UH=SCS, Weighted-CN, Time Span= 1.00-36.00 hrs, dt= 0.01 hrs  
Type III 24-hr 50-year Rainfall=7.10"

Area (sf)	CN	Description
* 9,176	98	Paved Impervious, HSG A
* 1,528	98	Paved Impervious, HSG B
3,894	98	Roofs, HSG A
8,917	98	Roofs, HSG B
12,216	39	>75% Grass cover, Good, HSG A
9,682	30	Woods, Good, HSG A
45,413	68	Weighted Average
21,898		48.22% Pervious Area
23,515		51.78% Impervious Area

Tc (min)	Length (feet)	Slope (ft/ft)	Velocity (ft/sec)	Capacity (cfs)	Description
6.4	50	0.1000	0.13		<b>Sheet Flow,</b> Woods: Light underbrush n= 0.400 P2= 3.30"
0.7	52	0.0570	1.19		<b>Shallow Concentrated Flow,</b> Woodland Kv= 5.0 fps
0.3	34	0.0580	1.69		<b>Shallow Concentrated Flow,</b> Short Grass Pasture Kv= 7.0 fps
7.4	136	Total			

**Cole Post-Development**

Prepared by Weston & Sampson

HydroCAD® 10.10-5a s/n 00455 © 2020 HydroCAD Software Solutions LLC

Type III 24-hr 50-year Rainfall=7.10"

Printed 7/12/2021

Page 87

**Subcatchment A8: SUB-A8**

Hydrograph

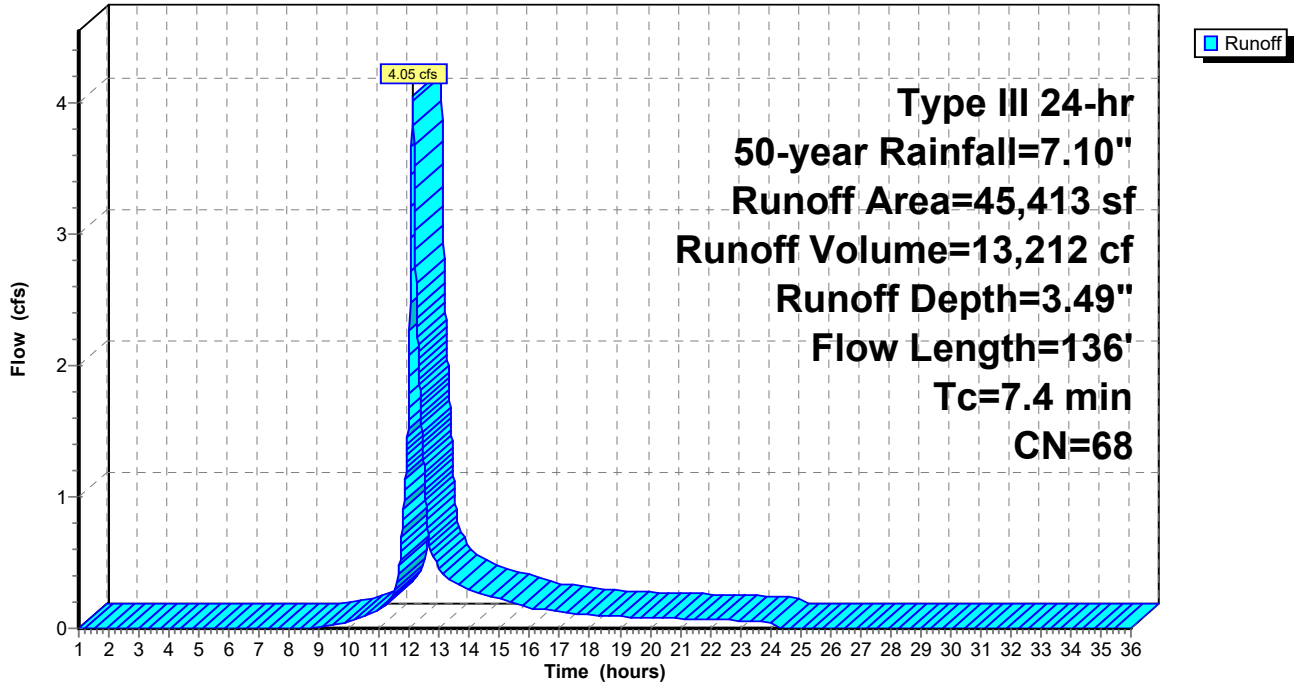

**Cole Post-Development**

Prepared by Weston & Sampson

HydroCAD® 10.10-5a s/n 00455 © 2020 HydroCAD Software Solutions LLC

Type III 24-hr 50-year Rainfall=7.10"

Printed 7/12/2021

Page 88

**Summary for Subcatchment B1: SUB-B1**

Runoff = 0.41 cfs @ 12.09 hrs, Volume= 1,317 cf, Depth= 2.67"

Runoff by SCS TR-20 method, UH=SCS, Weighted-CN, Time Span= 1.00-36.00 hrs, dt= 0.01 hrs  
Type III 24-hr 50-year Rainfall=7.10"

Area (sf)	CN	Description
5,112	61	>75% Grass cover, Good, HSG B
795	55	Woods, Good, HSG B
5,907	60	Weighted Average
5,907		100.00% Pervious Area

Tc (min)	Length (feet)	Slope (ft/ft)	Velocity (ft/sec)	Capacity (cfs)	Description
6.0					Direct Entry,

**Subcatchment B1: SUB-B1**

Hydrograph

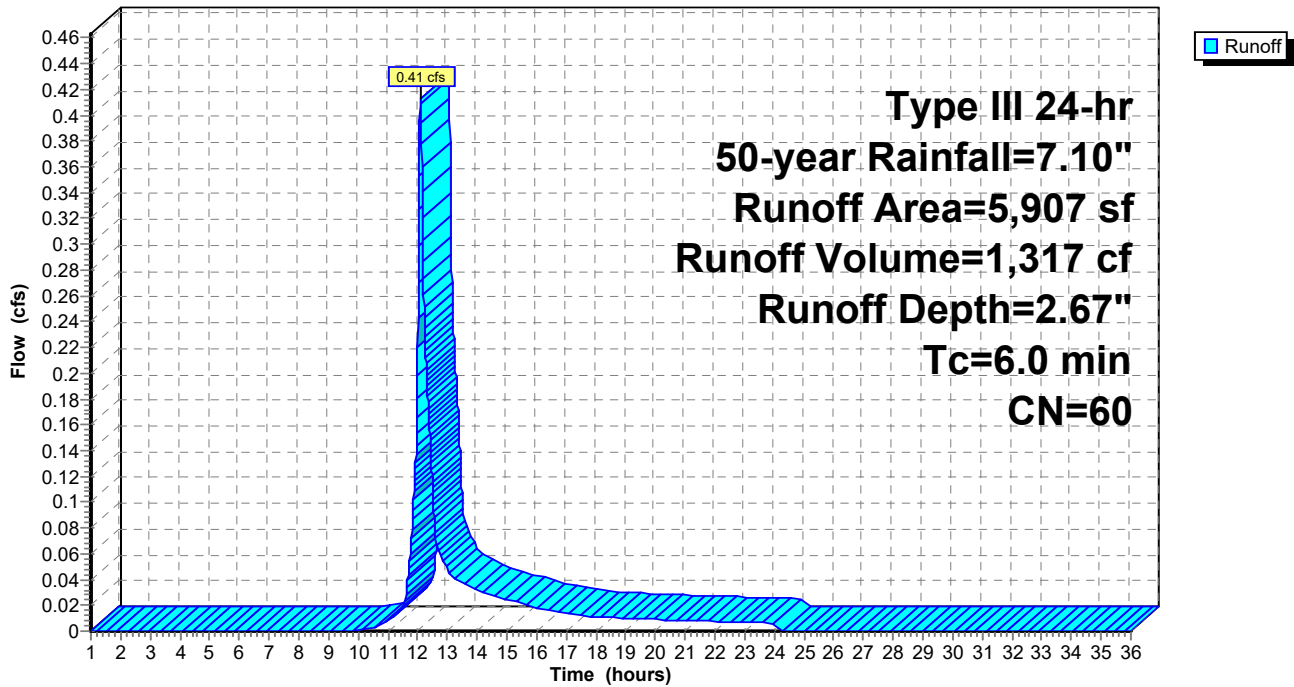

# Cole Post-Development

Prepared by Weston & Sampson

HydroCAD® 10.10-5a s/n 00455 © 2020 HydroCAD Software Solutions LLC

Type III 24-hr 50-year Rainfall=7.10"

Printed 7/12/2021

Page 89

## Summary for Pond A: POI-A

Inflow Area = 296,839 sf, 54.99% Impervious, Inflow Depth = 3.63" for 50-year event  
Inflow = 22.52 cfs @ 12.10 hrs, Volume= 89,745 cf  
Primary = 22.52 cfs @ 12.10 hrs, Volume= 89,745 cf, Atten= 0%, Lag= 0.0 min

Routing by Dyn-Stor-Ind method, Time Span= 1.00-36.00 hrs, dt= 0.01 hrs

### Pond A: POI-A

Hydrograph

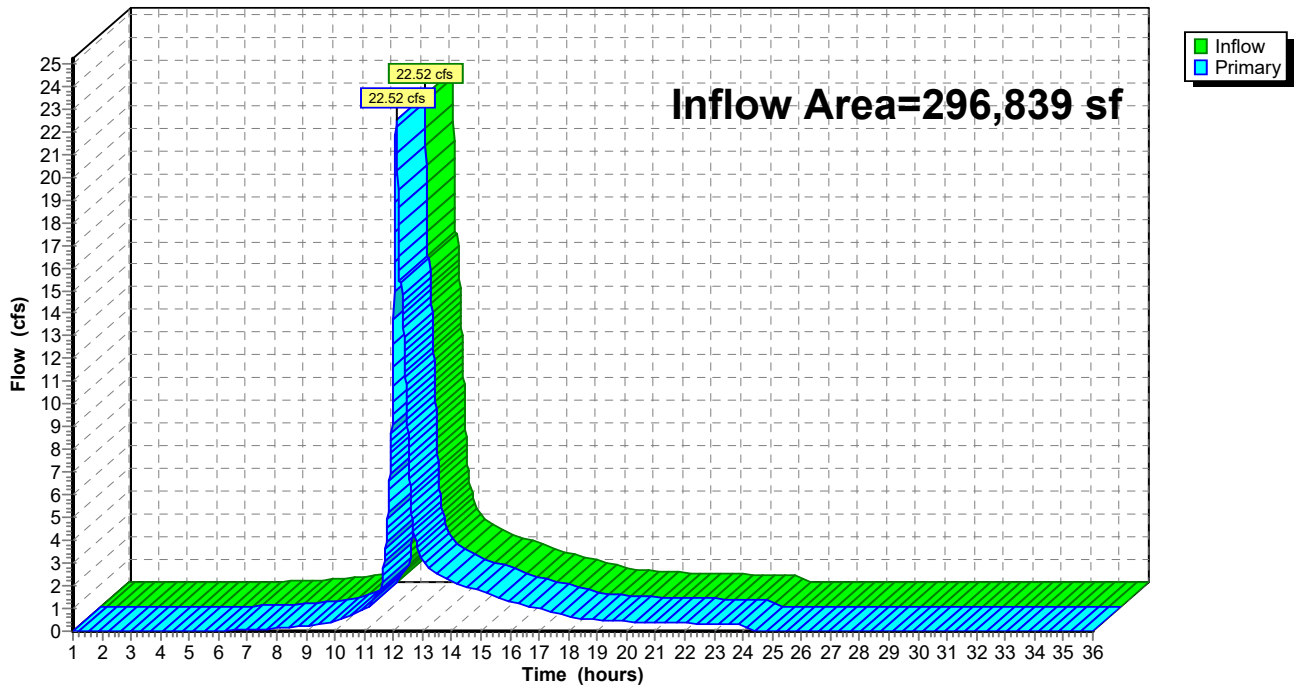

**Cole Post-Development**

Prepared by Weston & Sampson

HydroCAD® 10.10-5a s/n 00455 © 2020 HydroCAD Software Solutions LLC

Type III 24-hr 50-year Rainfall=7.10"

Printed 7/12/2021

Page 90

**Summary for Pond B: POI-B**

Inflow Area = 5,907 sf, 0.00% Impervious, Inflow Depth = 2.67" for 50-year event  
Inflow = 0.41 cfs @ 12.09 hrs, Volume= 1,317 cf  
Primary = 0.41 cfs @ 12.09 hrs, Volume= 1,317 cf, Atten= 0%, Lag= 0.0 min

Routing by Dyn-Stor-Ind method, Time Span= 1.00-36.00 hrs, dt= 0.01 hrs

**Pond B: POI-B**

Hydrograph

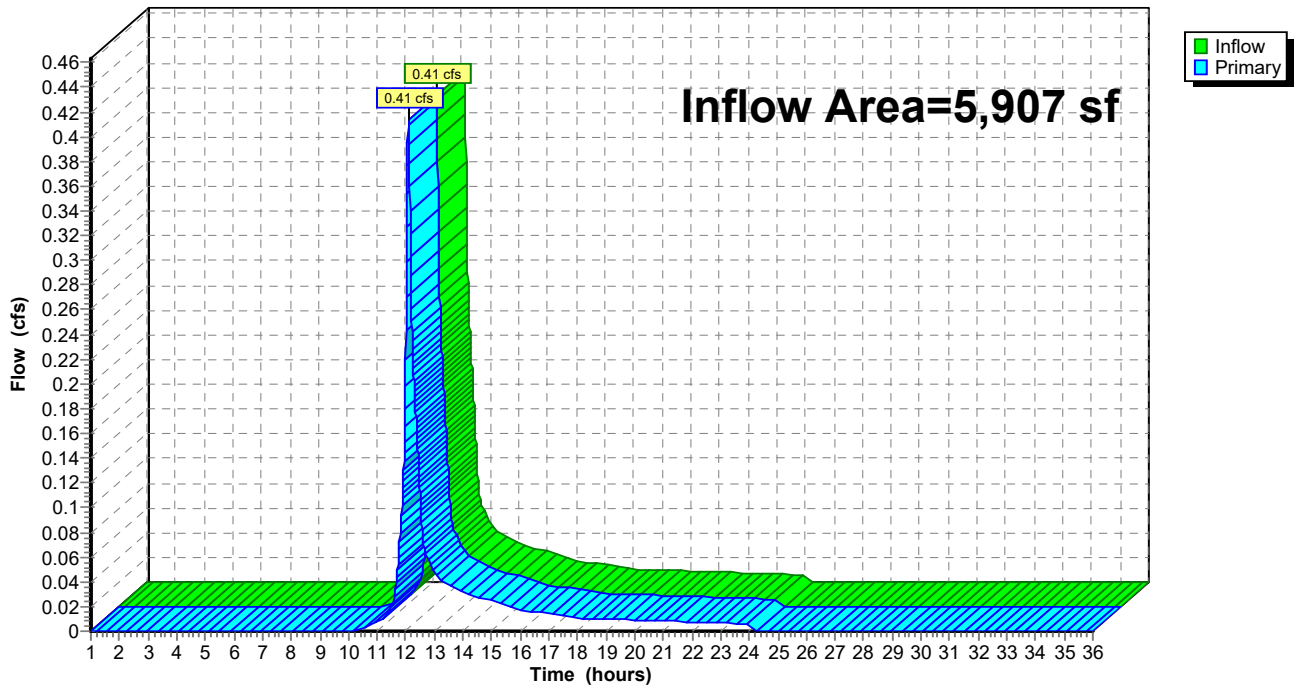

**Cole Post-Development**

Prepared by Weston & Sampson

HydroCAD® 10.10-5a s/n 00455 © 2020 HydroCAD Software Solutions LLC

Type III 24-hr 50-year Rainfall=7.10"

Printed 7/12/2021

Page 91

**Summary for Pond BR-1: BR-1**

Inflow Area = 16,500 sf, 77.45% Impervious, Inflow Depth = 5.46" for 50-year event  
 Inflow = 2.34 cfs @ 12.09 hrs, Volume= 7,510 cf  
 Outflow = 2.33 cfs @ 12.09 hrs, Volume= 6,700 cf, Atten= 1%, Lag= 0.5 min  
 Primary = 1.11 cfs @ 12.06 hrs, Volume= 6,105 cf  
 Secondary = 1.25 cfs @ 12.10 hrs, Volume= 595 cf

Routing by Dyn-Stor-Ind method, Time Span= 1.00-36.00 hrs, dt= 0.01 hrs  
 Peak Elev= 101.35' @ 12.10 hrs Surf.Area= 479 sf Storage= 1,023 cf

Plug-Flow detention time= 81.3 min calculated for 6,700 cf (89% of inflow)  
 Center-of-Mass det. time= 30.0 min ( 821.8 - 791.8 )

Volume	Invert	Avail.Storage	Storage Description	
#1	96.74'	1,245 cf	<b>Custom Stage Data (Prismatic)</b> Listed below (Recalc)	
Elevation (feet)	Surf.Area (sq-ft)	Voids (%)	Inc.Store (cubic-feet)	Cum.Store (cubic-feet)
96.74	641	0.0	0	0
96.75	641	40.0	3	3
97.24	641	40.0	126	128
97.25	641	30.0	2	130
100.24	641	30.0	575	705
100.25	641	40.0	3	708
100.49	641	40.0	62	769
100.50	88	100.0	4	773
101.00	335	100.0	106	879
101.75	641	100.0	366	1,245

Device	Routing	Invert	Outlet Devices
#1	Device 2	100.75'	<b>24.0" Horiz. Orifice/Grate</b> C= 0.600 Limited to weir flow at low heads
#2	Primary	94.49'	<b>12.0" Round Culvert</b> L= 62.8' CPP, projecting, no headwall, Ke= 0.900 Inlet / Outlet Invert= 94.49' / 94.18' S= 0.0049 '/' Cc= 0.900 n= 0.130, Flow Area= 0.79 sf
#3	Secondary	101.25'	<b>15.0' long x 10.0' breadth Broad-Crested Rectangular Weir</b> Head (feet) 0.20 0.40 0.60 0.80 1.00 1.20 1.40 1.60 Coef. (English) 2.49 2.56 2.70 2.69 2.68 2.69 2.67 2.64

**Primary OutFlow** Max=1.10 cfs @ 12.06 hrs HW=101.32' TW=95.27' (Dynamic Tailwater)  
 ↑2=Culvert (Outlet Controls 1.10 cfs @ 1.40 fps)  
 ↑1=Orifice/Grate (Passes 1.10 cfs of 8.77 cfs potential flow)

**Secondary OutFlow** Max=1.25 cfs @ 12.10 hrs HW=101.35' TW=95.71' (Dynamic Tailwater)  
 ↑3=Broad-Crested Rectangular Weir (Weir Controls 1.25 cfs @ 0.80 fps)

# Cole Post-Development

Prepared by Weston & Sampson

HydroCAD® 10.10-5a s/n 00455 © 2020 HydroCAD Software Solutions LLC

Type III 24-hr 50-year Rainfall=7.10"

Printed 7/12/2021

Page 92

## Pond BR-1: BR-1

Hydrograph

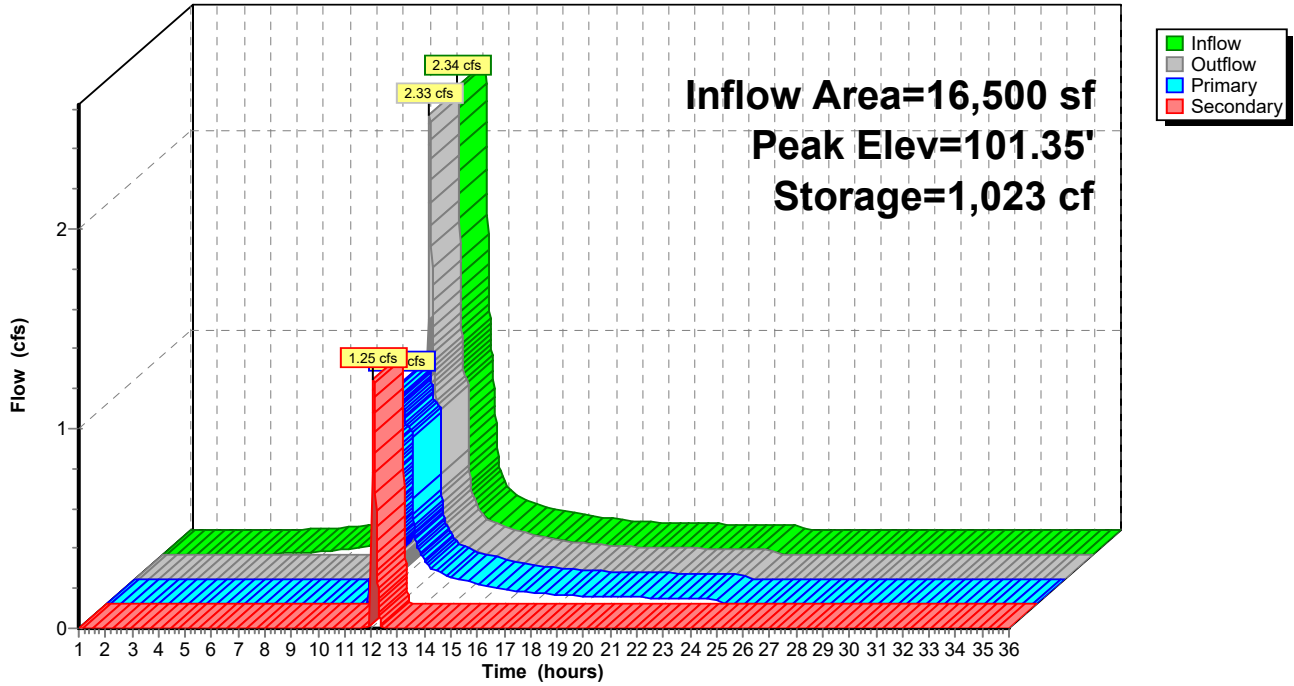



# Cole Post-Development

Prepared by Weston & Sampson

HydroCAD® 10.10-5a s/n 00455 © 2020 HydroCAD Software Solutions LLC

Type III 24-hr 50-year Rainfall=7.10"

Printed 7/12/2021

Page 93

## Summary for Pond DS-1: DS-1

Inflow Area = 35,193 sf, 61.85% Impervious, Inflow Depth = 4.46" for 50-year event  
 Inflow = 3.81 cfs @ 12.12 hrs, Volume= 13,068 cf  
 Outflow = 3.79 cfs @ 12.13 hrs, Volume= 13,067 cf, Atten= 1%, Lag= 0.6 min  
 Primary = 3.79 cfs @ 12.13 hrs, Volume= 13,067 cf

Routing by Dyn-Stor-Ind method, Time Span= 1.00-36.00 hrs, dt= 0.01 hrs  
 Peak Elev= 90.37' @ 12.13 hrs Surf.Area= 658 sf Storage= 916 cf

Plug-Flow detention time= 17.5 min calculated for 13,063 cf (100% of inflow)  
 Center-of-Mass det. time= 17.6 min ( 834.8 - 817.2 )

Volume	Invert	Avail.Storage	Storage Description
#1A	88.25'	627 cf	<b>20.50'W x 32.10'L x 3.50'H Field A</b> 2,303 cf Overall - 735 cf Embedded = 1,568 cf x 40.0% Voids
#2A	88.75'	735 cf	<b>ADS_StormTech SC-740 +Cap</b> x 16 Inside #1 Effective Size= 44.6"W x 30.0"H => 6.45 sf x 7.12'L = 45.9 cf Overall Size= 51.0"W x 30.0"H x 7.56'L with 0.44' Overlap 16 Chambers in 4 Rows
		1,362 cf	Total Available Storage

Storage Group A created with Chamber Wizard

Device	Routing	Invert	Outlet Devices
#1	Primary	88.25'	<b>24.0" Round Culvert</b> L= 26.9' CPP, projecting, no headwall, Ke= 0.900 Inlet / Outlet Invert= 88.25' / 88.12' S= 0.0048 '/' Cc= 0.900 n= 0.013 Corrugated PE, smooth interior, Flow Area= 3.14 sf
#2	Device 1	89.95'	<b>4.0' long Sharp-Crested Rectangular Weir</b> 2 End Contraction(s)
#3	Device 1	88.25'	<b>3.0" Vert. Orifice/Grate</b> C= 0.600 Limited to weir flow at low heads

**Primary OutFlow** Max=3.78 cfs @ 12.13 hrs HW=90.37' TW=0.00' (Dynamic Tailwater)

- ↑ **1=Culvert** (Passes 3.78 cfs of 11.86 cfs potential flow)
- ↑ **2=Sharp-Crested Rectangular Weir** (Weir Controls 3.45 cfs @ 2.11 fps)
- ↑ **3=Orifice/Grate** (Orifice Controls 0.33 cfs @ 6.80 fps)

**Cole Post-Development**

Prepared by Weston & Sampson

HydroCAD® 10.10-5a s/n 00455 © 2020 HydroCAD Software Solutions LLC

Type III 24-hr 50-year Rainfall=7.10"

Printed 7/12/2021

Page 94

**Pond DS-1: DS-1 - Chamber Wizard Field A**

**Chamber Model = ADS\_StormTechSC-740 +Cap (ADS StormTech®SC-740 with cap length)**

Effective Size= 44.6"W x 30.0"H => 6.45 sf x 7.12'L = 45.9 cf

Overall Size= 51.0"W x 30.0"H x 7.56'L with 0.44' Overlap

51.0" Wide + 6.0" Spacing = 57.0" C-C Row Spacing

4 Chambers/Row x 7.12' Long +0.81' Cap Length x 2 = 30.10' Row Length +12.0" End Stone x 2 = 32.10' Base Length

4 Rows x 51.0" Wide + 6.0" Spacing x 3 + 12.0" Side Stone x 2 = 20.50' Base Width

6.0" Stone Base + 30.0" Chamber Height + 6.0" Stone Cover = 3.50' Field Height

16 Chambers x 45.9 cf = 735.0 cf Chamber Storage

2,302.9 cf Field - 735.0 cf Chambers = 1,567.9 cf Stone x 40.0% Voids = 627.2 cf Stone Storage

Chamber Storage + Stone Storage = 1,362.2 cf = 0.031 af

Overall Storage Efficiency = 59.2%

Overall System Size = 32.10' x 20.50' x 3.50'

16 Chambers

85.3 cy Field

58.1 cy Stone

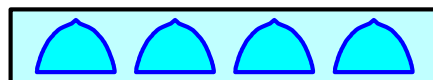
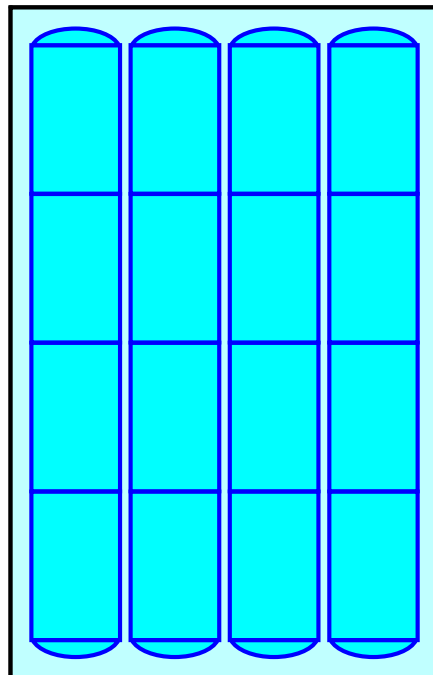

**Cole Post-Development**

Prepared by Weston & Sampson

HydroCAD® 10.10-5a s/n 00455 © 2020 HydroCAD Software Solutions LLC

Type III 24-hr 50-year Rainfall=7.10"

Printed 7/12/2021

Page 95

**Pond DS-1: DS-1**

Hydrograph

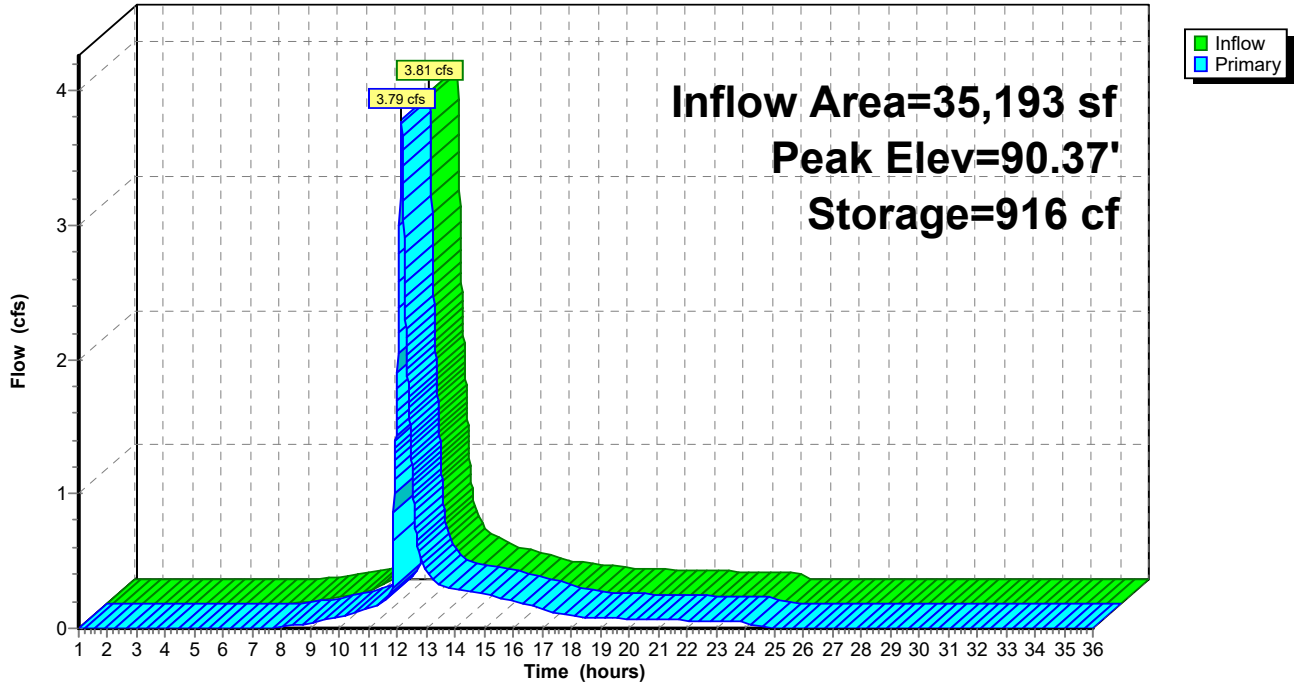

# Cole Post-Development

Prepared by Weston & Sampson

HydroCAD® 10.10-5a s/n 00455 © 2020 HydroCAD Software Solutions LLC

Type III 24-hr 50-year Rainfall=7.10"

Printed 7/12/2021

Page 96

## Summary for Pond IS-1: IS-1

Inflow Area = 61,597 sf, 85.38% Impervious, Inflow Depth = 5.81" for 50-year event  
Inflow = 9.24 cfs @ 12.09 hrs, Volume= 29,825 cf  
Outflow = 3.61 cfs @ 12.31 hrs, Volume= 29,825 cf, Atten= 61%, Lag= 13.7 min  
Discarded = 0.28 cfs @ 12.31 hrs, Volume= 16,466 cf  
Primary = 3.33 cfs @ 12.31 hrs, Volume= 13,360 cf

Routing by Dyn-Stor-Ind method, Time Span= 1.00-36.00 hrs, dt= 0.01 hrs  
Peak Elev= 97.35' @ 12.31 hrs Surf.Area= 3,603 sf Storage= 11,276 cf

Plug-Flow detention time= 152.8 min calculated for 29,817 cf (100% of inflow)  
Center-of-Mass det. time= 152.8 min ( 936.3 - 783.4 )

Volume	Invert	Avail.Storage	Storage Description
#1A	92.50'	5,063 cf	<b>29.92'W x 120.42'L x 5.50'H Field A</b> 19,814 cf Overall - 7,156 cf Embedded = 12,658 cf x 40.0% Voids
#2A	93.25'	7,156 cf	<b>ADS_StormTech MC-3500 d +Capx 64</b> Inside #1 Effective Size= 70.4"W x 45.0"H => 15.33 sf x 7.17'L = 110.0 cf Overall Size= 77.0"W x 45.0"H x 7.50'L with 0.33' Overlap 64 Chambers in 4 Rows Cap Storage= +14.9 cf x 2 x 4 rows = 119.2 cf
		12,219 cf	Total Available Storage

Storage Group A created with Chamber Wizard

Device	Routing	Invert	Outlet Devices
#1	Discarded	92.50'	<b>2.410 in/hr Exfiltration over Wetted area</b> Phase-In= 0.01'
#2	Primary	92.00'	<b>12.0" Round Culvert</b> L= 91.3' CPP, projecting, no headwall, Ke= 0.900 Inlet / Outlet Invert= 92.00' / 91.09' S= 0.0100 '/' Cc= 0.900 n= 0.013 Corrugated PE, smooth interior, Flow Area= 0.79 sf
#3	Device 2	97.00'	<b>4.0' long Sharp-Crested Rectangular Weir</b> 2 End Contraction(s)
#4	Device 2	94.20'	<b>4.0" Vert. Orifice/Grate</b> C= 0.600 Limited to weir flow at low heads

**Discarded OutFlow** Max=0.28 cfs @ 12.31 hrs HW=97.34' (Free Discharge)

↑ **1=Exfiltration** (Exfiltration Controls 0.28 cfs)

**Primary OutFlow** Max=3.33 cfs @ 12.31 hrs HW=97.34' TW=0.00' (Dynamic Tailwater)

↑ **2=Culvert** (Passes 3.33 cfs of 6.57 cfs potential flow)

↑ **3=Sharp-Crested Rectangular Weir** (Weir Controls 2.60 cfs @ 1.92 fps)

↑ **4=Orifice/Grate** (Orifice Controls 0.73 cfs @ 8.31 fps)

**Cole Post-Development**

Prepared by Weston & Sampson

HydroCAD® 10.10-5a s/n 00455 © 2020 HydroCAD Software Solutions LLC

Type III 24-hr 50-year Rainfall=7.10"

Printed 7/12/2021

Page 97

**Pond IS-1: IS-1 - Chamber Wizard Field A**

**Chamber Model = ADS\_StormTechMC-3500 d +Cap (ADS StormTech®MC-3500 d rev 03/14 with Cap volume)**

Effective Size= 70.4"W x 45.0"H => 15.33 sf x 7.17'L = 110.0 cf

Overall Size= 77.0"W x 45.0"H x 7.50'L with 0.33' Overlap

Cap Storage= +14.9 cf x 2 x 4 rows = 119.2 cf

77.0" Wide + 9.0" Spacing = 86.0" C-C Row Spacing

16 Chambers/Row x 7.17' Long +1.85' Cap Length x 2 = 118.42' Row Length +12.0" End Stone x 2 = 120.42' Base Length

4 Rows x 77.0" Wide + 9.0" Spacing x 3 + 12.0" Side Stone x 2 = 29.92' Base Width

9.0" Stone Base + 45.0" Chamber Height + 12.0" Stone Cover = 5.50' Field Height

64 Chambers x 110.0 cf + 14.9 cf Cap Volume x 2 x 4 Rows = 7,156.1 cf Chamber Storage

19,814.1 cf Field - 7,156.1 cf Chambers = 12,658.0 cf Stone x 40.0% Voids = 5,063.2 cf Stone Storage

Chamber Storage + Stone Storage = 12,219.3 cf = 0.281 af

Overall Storage Efficiency = 61.7%

Overall System Size = 120.42' x 29.92' x 5.50'

64 Chambers

733.9 cy Field

468.8 cy Stone

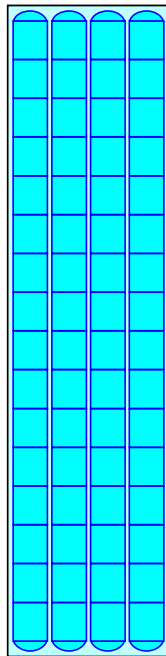

# Cole Post-Development

Prepared by Weston & Sampson

HydroCAD® 10.10-5a s/n 00455 © 2020 HydroCAD Software Solutions LLC

Type III 24-hr 50-year Rainfall=7.10"

Printed 7/12/2021

Page 98

## Pond IS-1: IS-1

Hydrograph

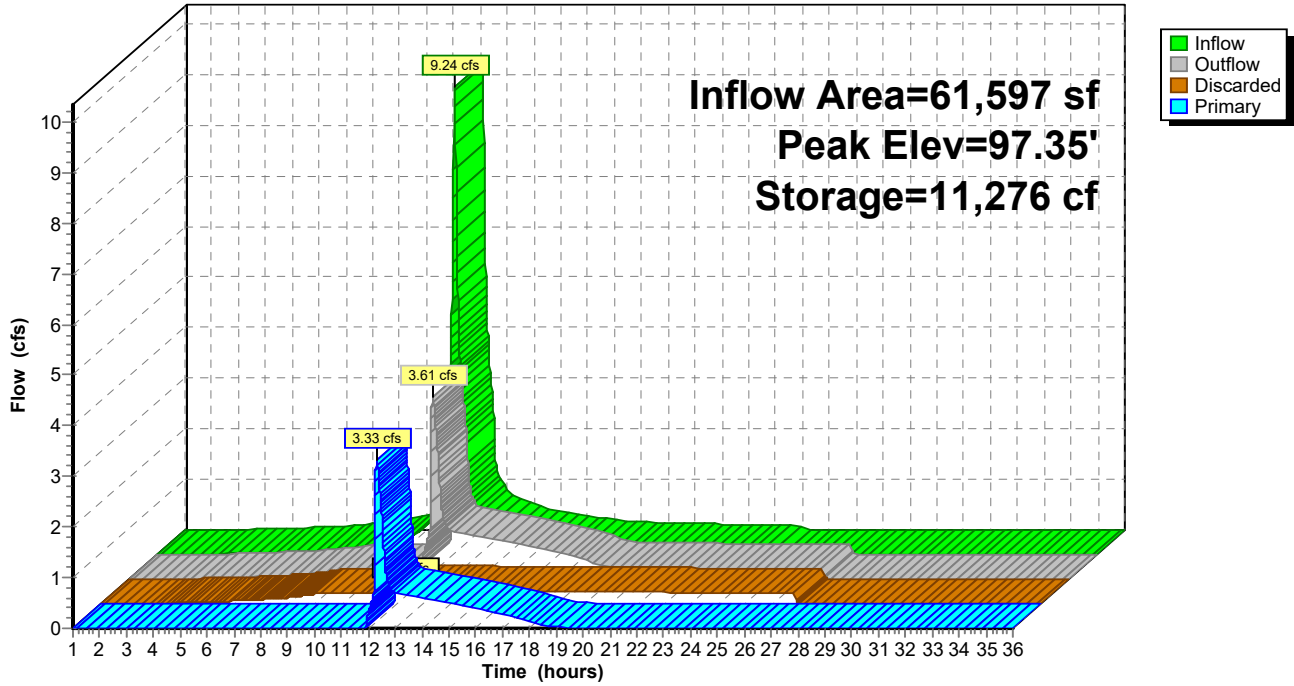

**Cole Post-Development**

Type III 24-hr 100-year Rainfall=8.30"

Prepared by Weston &amp; Sampson

Printed 7/12/2021

HydroCAD® 10.10-5a s/n 00455 © 2020 HydroCAD Software Solutions LLC

Page 99

Time span=1.00-36.00 hrs, dt=0.01 hrs, 3501 points  
 Runoff by SCS TR-20 method, UH=SCS, Weighted-CN  
 Reach routing by Dyn-Stor-Ind method - Pond routing by Dyn-Stor-Ind method

**SubcatchmentA1: SUB-A1** Runoff Area=67,238 sf 64.49% Impervious Runoff Depth=6.50"  
 Tc=6.0 min CN=85 Runoff=11.32 cfs 36,437 cf

**SubcatchmentA2: SUB-A2** Runoff Area=35,193 sf 61.85% Impervious Runoff Depth=5.55"  
 Flow Length=160' Tc=8.9 min CN=77 Runoff=4.72 cfs 16,277 cf

**SubcatchmentA3: SUB-A3** Runoff Area=16,500 sf 77.45% Impervious Runoff Depth=6.62"  
 Tc=6.0 min CN=86 Runoff=2.81 cfs 9,106 cf

**SubcatchmentA4: SUB-A4** Runoff Area=45,097 sf 88.28% Impervious Runoff Depth=7.34"  
 Tc=6.0 min CN=92 Runoff=8.18 cfs 27,587 cf

**SubcatchmentA5: SUB-A2** Runoff Area=11,510 sf 59.26% Impervious Runoff Depth=5.19"  
 Tc=6.0 min CN=74 Runoff=1.60 cfs 4,983 cf

**SubcatchmentA6: SUB-A4** Runoff Area=44,811 sf 26.24% Impervious Runoff Depth=3.33"  
 Flow Length=463' Tc=12.7 min CN=58 Runoff=3.16 cfs 12,439 cf

**SubcatchmentA7: SUB-A7** Runoff Area=31,077 sf 11.00% Impervious Runoff Depth=3.56"  
 Tc=6.0 min CN=60 Runoff=2.94 cfs 9,219 cf

**SubcatchmentA8: SUB-A8** Runoff Area=45,413 sf 51.78% Impervious Runoff Depth=4.49"  
 Flow Length=136' Tc=7.4 min CN=68 Runoff=5.23 cfs 16,986 cf

**SubcatchmentB1: SUB-B1** Runoff Area=5,907 sf 0.00% Impervious Runoff Depth=3.56"  
 Tc=6.0 min CN=60 Runoff=0.56 cfs 1,752 cf

**Pond A: POI-A** Inflow=31.24 cfs 114,672 cf  
 Primary=31.24 cfs 114,672 cf

**Pond B: POI-B** Inflow=0.56 cfs 1,752 cf  
 Primary=0.56 cfs 1,752 cf

**Pond BR-1: BR-1** Peak Elev=101.38' Storage=1,037 cf Inflow=2.81 cfs 9,106 cf  
 Primary=1.08 cfs 7,176 cf Secondary=1.80 cfs 1,120 cf Outflow=2.79 cfs 8,296 cf

**Pond DS-1: DS-1** Peak Elev=90.44' Storage=946 cf Inflow=4.72 cfs 16,277 cf  
 Outflow=4.70 cfs 16,277 cf

**Pond IS-1: IS-1** Peak Elev=97.63' Storage=11,693 cf Inflow=10.96 cfs 35,882 cf  
 Discarded=0.29 cfs 17,552 cf Primary=6.77 cfs 18,330 cf Outflow=7.05 cfs 35,882 cf

**Total Runoff Area = 302,746 sf Runoff Volume = 134,788 cf Average Runoff Depth = 5.34"**  
**46.08% Pervious = 139,512 sf 53.92% Impervious = 163,234 sf**

**Cole Post-Development**

Prepared by Weston & Sampson

HydroCAD® 10.10-5a s/n 00455 © 2020 HydroCAD Software Solutions LLC

Type III 24-hr 100-year Rainfall=8.30"

Printed 7/12/2021

Page 100

**Summary for Subcatchment A1: SUB-A1**

Runoff = 11.32 cfs @ 12.08 hrs, Volume= 36,437 cf, Depth= 6.50"

Runoff by SCS TR-20 method, UH=SCS, Weighted-CN, Time Span= 1.00-36.00 hrs, dt= 0.01 hrs  
Type III 24-hr 100-year Rainfall=8.30"

	Area (sf)	CN	Description
*	27,200	98	Paved Impervious, HSG B
	16,163	98	Roofs, HSG B
	23,006	61	>75% Grass cover, Good, HSG B
	869	55	Woods, Good, HSG B
	67,238	85	Weighted Average
	23,875		35.51% Pervious Area
	43,363		64.49% Impervious Area

Tc (min)	Length (feet)	Slope (ft/ft)	Velocity (ft/sec)	Capacity (cfs)	Description
6.0					Direct Entry,

**Subcatchment A1: SUB-A1**

Hydrograph

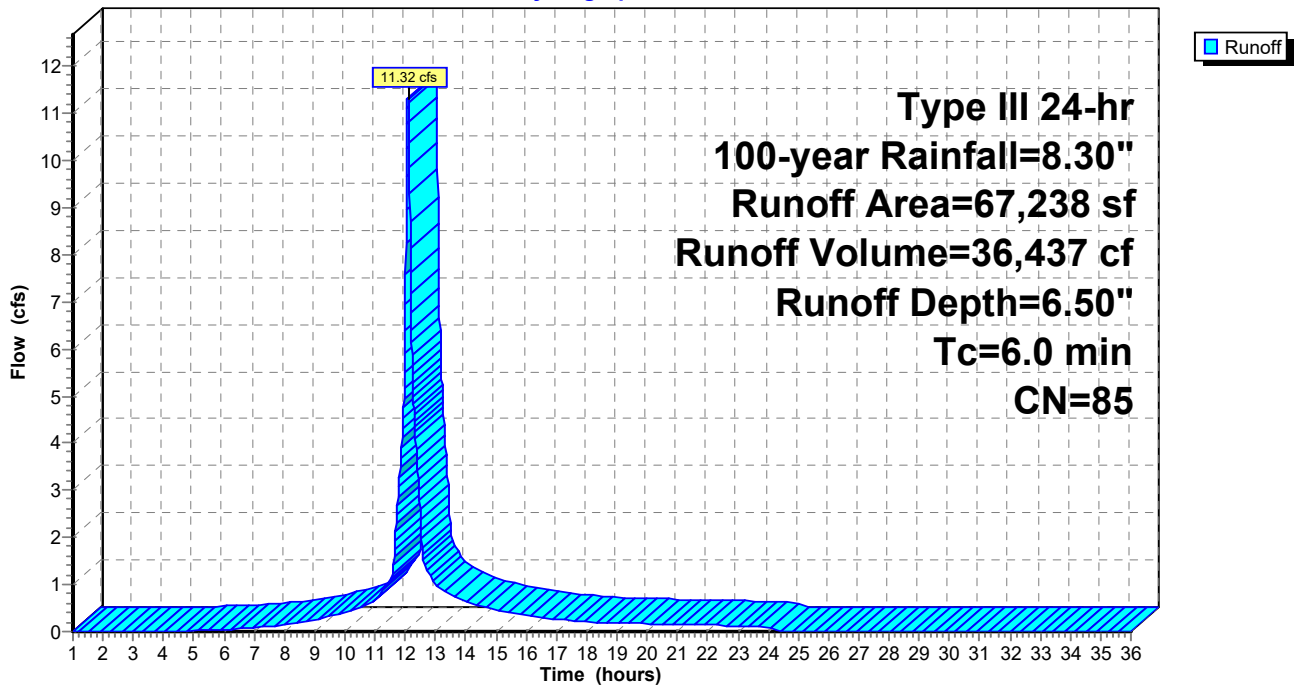



**Cole Post-Development**

Prepared by Weston & Sampson

HydroCAD® 10.10-5a s/n 00455 © 2020 HydroCAD Software Solutions LLC

Type III 24-hr 100-year Rainfall=8.30"

Printed 7/12/2021

Page 101

**Summary for Subcatchment A2: SUB-A2**

Runoff = 4.72 cfs @ 12.12 hrs, Volume= 16,277 cf, Depth= 5.55"

Runoff by SCS TR-20 method, UH=SCS, Weighted-CN, Time Span= 1.00-36.00 hrs, dt= 0.01 hrs  
Type III 24-hr 100-year Rainfall=8.30"

Area (sf)	CN	Description
* 23	98	Paved Impervious, HSG A
* 18,246	98	Paved Impervious, HSG B
3,498	98	Roofs, HSG B
1,694	39	>75% Grass cover, Good, HSG A
4,693	61	>75% Grass cover, Good, HSG B
6,952	30	Woods, Good, HSG A
87	55	Woods, Good, HSG B
35,193	77	Weighted Average
13,426		38.15% Pervious Area
21,767		61.85% Impervious Area

Tc (min)	Length (feet)	Slope (ft/ft)	Velocity (ft/sec)	Capacity (cfs)	Description
7.4	50	0.0700	0.11		<b>Sheet Flow,</b> Woods: Light underbrush n= 0.400 P2= 3.30"
0.5	33	0.0450	1.06		<b>Shallow Concentrated Flow,</b> Woodland Kv= 5.0 fps
0.9	59	0.0250	1.11		<b>Shallow Concentrated Flow,</b> Short Grass Pasture Kv= 7.0 fps
0.1	18	0.0150	2.49		<b>Shallow Concentrated Flow,</b> Paved Kv= 20.3 fps
8.9	160	Total			

**Cole Post-Development**

Prepared by Weston & Sampson

HydroCAD® 10.10-5a s/n 00455 © 2020 HydroCAD Software Solutions LLC

Type III 24-hr 100-year Rainfall=8.30"

Printed 7/12/2021

Page 102

**Subcatchment A2: SUB-A2**

Hydrograph

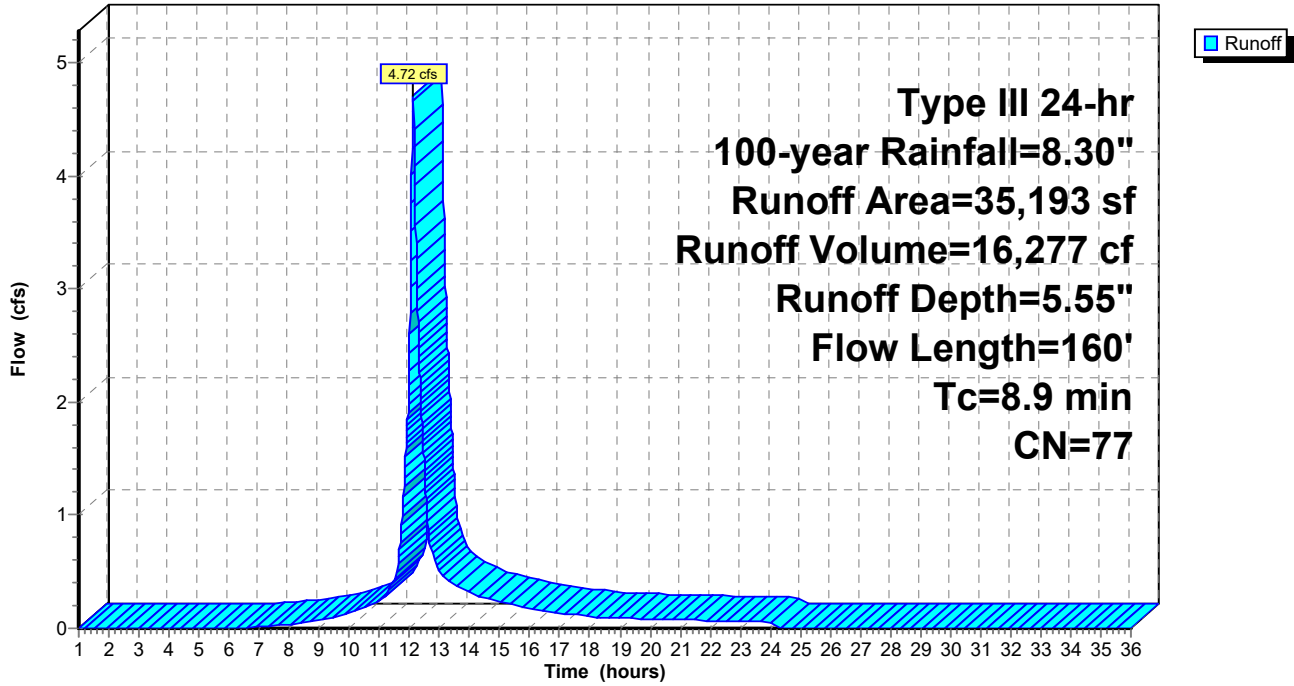

**Cole Post-Development**

Prepared by Weston & Sampson

HydroCAD® 10.10-5a s/n 00455 © 2020 HydroCAD Software Solutions LLC

Type III 24-hr 100-year Rainfall=8.30"

Printed 7/12/2021

Page 103

**Summary for Subcatchment A3: SUB-A3**

Runoff = 2.81 cfs @ 12.08 hrs, Volume= 9,106 cf, Depth= 6.62"

Runoff by SCS TR-20 method, UH=SCS, Weighted-CN, Time Span= 1.00-36.00 hrs, dt= 0.01 hrs  
Type III 24-hr 100-year Rainfall=8.30"

	Area (sf)	CN	Description
*	4,196	98	Paved Impervious, HSG A
*	1,717	98	Paved Impervious, HSG B
	6,866	98	Roofs, HSG B
	2,808	39	>75% Grass cover, Good, HSG A
	913	61	>75% Grass cover, Good, HSG B
	16,500	86	Weighted Average
	3,721		22.55% Pervious Area
	12,779		77.45% Impervious Area

Tc (min)	Length (feet)	Slope (ft/ft)	Velocity (ft/sec)	Capacity (cfs)	Description
6.0					Direct Entry,

**Subcatchment A3: SUB-A3**

Hydrograph

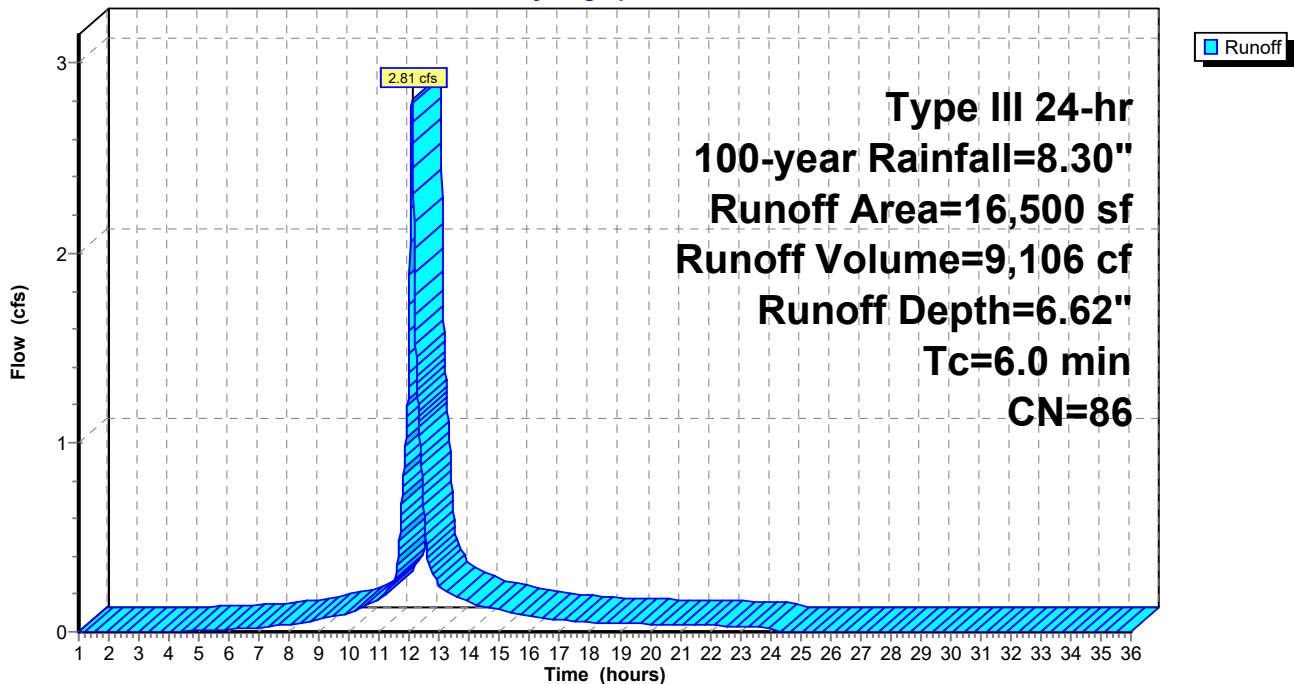

**Cole Post-Development**

Prepared by Weston & Sampson

HydroCAD® 10.10-5a s/n 00455 © 2020 HydroCAD Software Solutions LLC

Type III 24-hr 100-year Rainfall=8.30"

Printed 7/12/2021

Page 104

**Summary for Subcatchment A4: SUB-A4**

Runoff = 8.18 cfs @ 12.08 hrs, Volume= 27,587 cf, Depth= 7.34"

Runoff by SCS TR-20 method, UH=SCS, Weighted-CN, Time Span= 1.00-36.00 hrs, dt= 0.01 hrs  
Type III 24-hr 100-year Rainfall=8.30"

	Area (sf)	CN	Description
*	28,479	98	Paved Impervious, HSG A
*	4,701	98	Paved Impervious, HSG B
	3,540	98	Roofs, HSG A
	3,092	98	Roofs, HSG B
	3,675	39	>75% Grass cover, Good, HSG A
	1,610	61	>75% Grass cover, Good, HSG B
	45,097	92	Weighted Average
	5,285		11.72% Pervious Area
	39,812		88.28% Impervious Area

Tc (min)	Length (feet)	Slope (ft/ft)	Velocity (ft/sec)	Capacity (cfs)	Description
6.0					Direct Entry,

**Subcatchment A4: SUB-A4**

Hydrograph

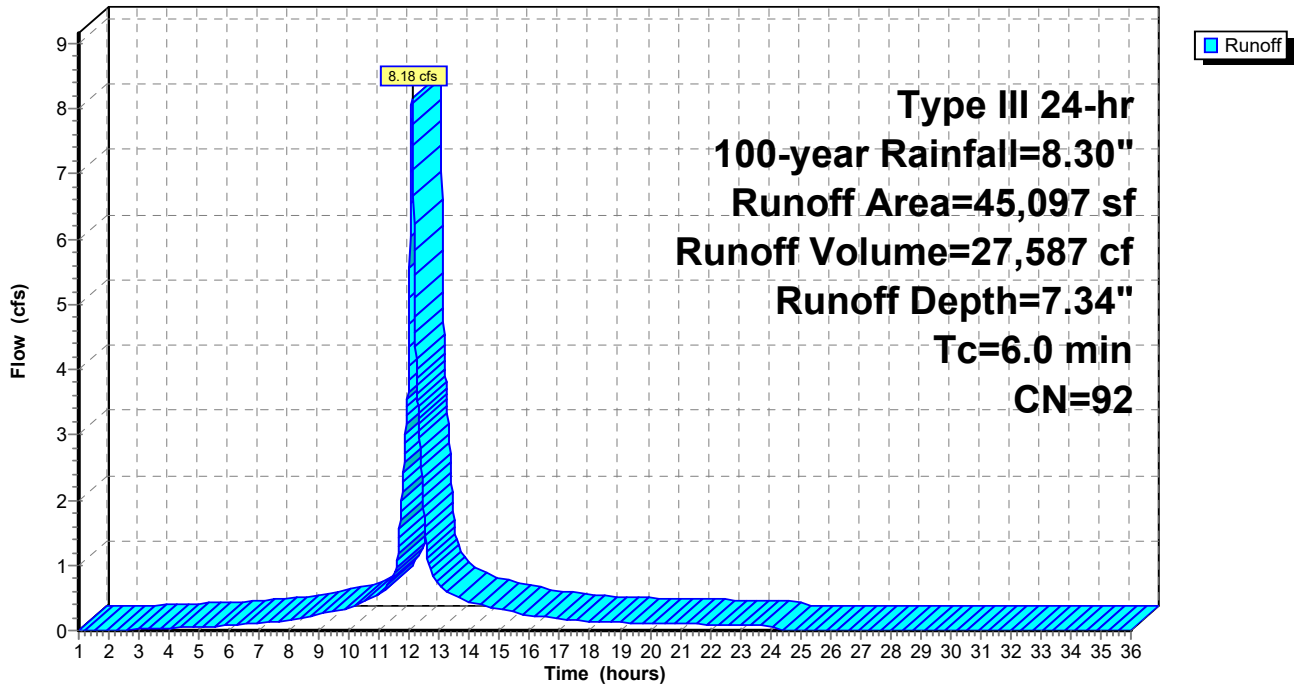

**Cole Post-Development**

Prepared by Weston & Sampson

HydroCAD® 10.10-5a s/n 00455 © 2020 HydroCAD Software Solutions LLC

Type III 24-hr 100-year Rainfall=8.30"

Printed 7/12/2021

Page 105

**Summary for Subcatchment A5: SUB-A2**

Runoff = 1.60 cfs @ 12.09 hrs, Volume= 4,983 cf, Depth= 5.19"

Runoff by SCS TR-20 method, UH=SCS, Weighted-CN, Time Span= 1.00-36.00 hrs, dt= 0.01 hrs  
Type III 24-hr 100-year Rainfall=8.30"

	Area (sf)	CN	Description
*	5,725	98	Paved Impervious, HSG A
*	1,096	98	Paved Impervious, HSG B
	4,689	39	>75% Grass cover, Good, HSG A
	11,510	74	Weighted Average
	4,689		40.74% Pervious Area
	6,821		59.26% Impervious Area

Tc (min)	Length (feet)	Slope (ft/ft)	Velocity (ft/sec)	Capacity (cfs)	Description
6.0					Direct Entry,

**Subcatchment A5: SUB-A2**

Hydrograph

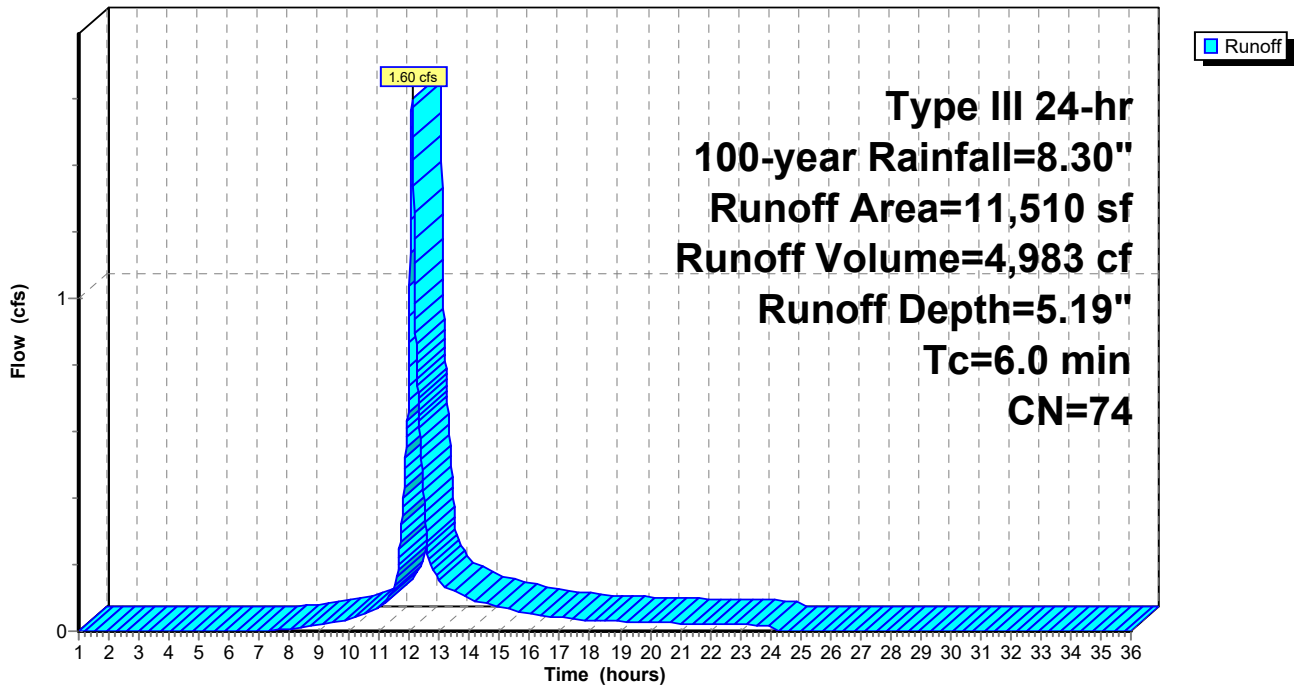

**Cole Post-Development**

Prepared by Weston & Sampson

HydroCAD® 10.10-5a s/n 00455 © 2020 HydroCAD Software Solutions LLC

Type III 24-hr 100-year Rainfall=8.30"

Printed 7/12/2021

Page 106

**Summary for Subcatchment A6: SUB-A4**

Runoff = 3.16 cfs @ 12.18 hrs, Volume= 12,439 cf, Depth= 3.33"

Runoff by SCS TR-20 method, UH=SCS, Weighted-CN, Time Span= 1.00-36.00 hrs, dt= 0.01 hrs  
Type III 24-hr 100-year Rainfall=8.30"

Area (sf)	CN	Description
* 3,625	98	Paved Impervious, HSG A
* 8,132	98	Paved Impervious, HSG B
13,635	30	Woods, Good, HSG A
13,102	55	Woods, Good, HSG B
2,357	39	>75% Grass cover, Good, HSG A
3,960	61	>75% Grass cover, Good, HSG B
44,811	58	Weighted Average
33,054		73.76% Pervious Area
11,757		26.24% Impervious Area

Tc (min)	Length (feet)	Slope (ft/ft)	Velocity (ft/sec)	Capacity (cfs)	Description
7.8	50	0.0600	0.11		<b>Sheet Flow,</b> Woods: Light underbrush n= 0.400 P2= 3.30"
2.5	120	0.0250	0.79		<b>Shallow Concentrated Flow,</b> Woodland Kv= 5.0 fps
2.4	293	0.0100	2.03		<b>Shallow Concentrated Flow,</b> Paved Kv= 20.3 fps
12.7	463	Total			

**Subcatchment A6: SUB-A4**

Hydrograph

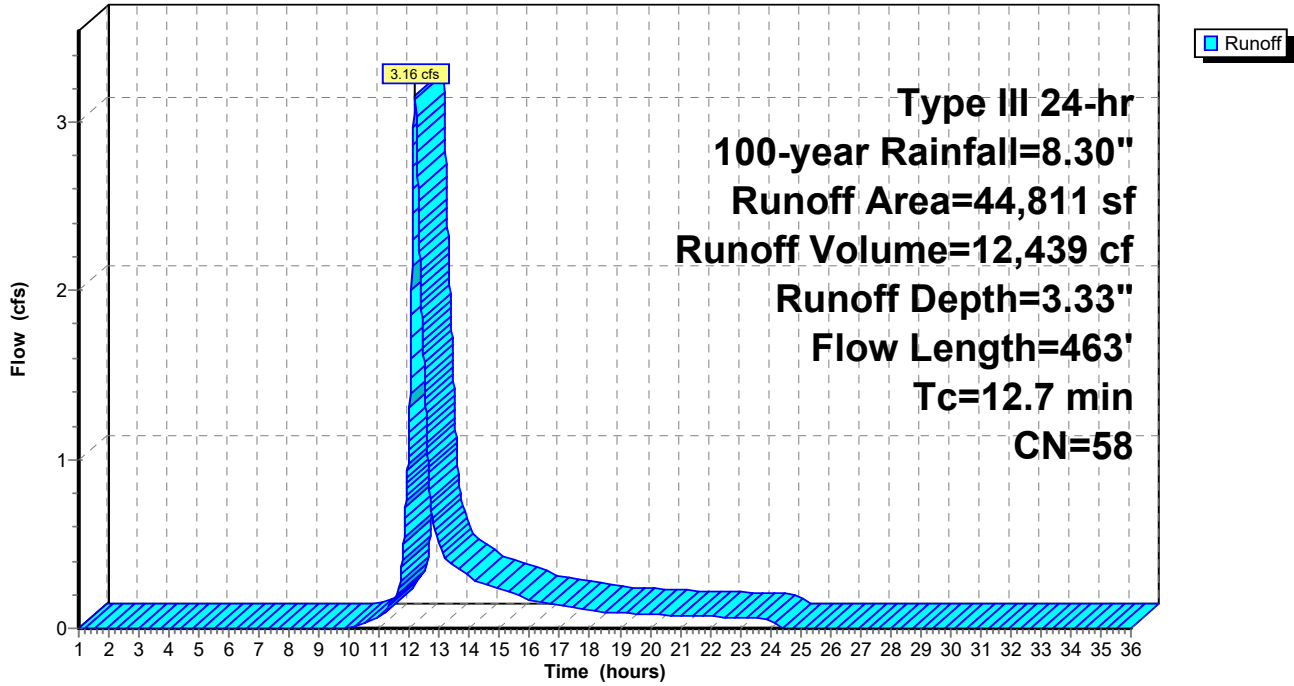

**Cole Post-Development**

Prepared by Weston & Sampson

HydroCAD® 10.10-5a s/n 00455 © 2020 HydroCAD Software Solutions LLC

Type III 24-hr 100-year Rainfall=8.30"

Printed 7/12/2021

Page 108

**Summary for Subcatchment A7: SUB-A7**

Runoff = 2.94 cfs @ 12.09 hrs, Volume= 9,219 cf, Depth= 3.56"

Runoff by SCS TR-20 method, UH=SCS, Weighted-CN, Time Span= 1.00-36.00 hrs, dt= 0.01 hrs  
Type III 24-hr 100-year Rainfall=8.30"

Area (sf)	CN	Description
* 3,420	98	Paved Impervious, HSG B
523	39	>75% Grass cover, Good, HSG A
16,801	61	>75% Grass cover, Good, HSG B
3,334	30	Woods, Good, HSG A
6,999	55	Woods, Good, HSG B
31,077	60	Weighted Average
27,657		89.00% Pervious Area
3,420		11.00% Impervious Area

Tc (min)	Length (feet)	Slope (ft/ft)	Velocity (ft/sec)	Capacity (cfs)	Description
6.0					Direct Entry,

**Subcatchment A7: SUB-A7**

Hydrograph

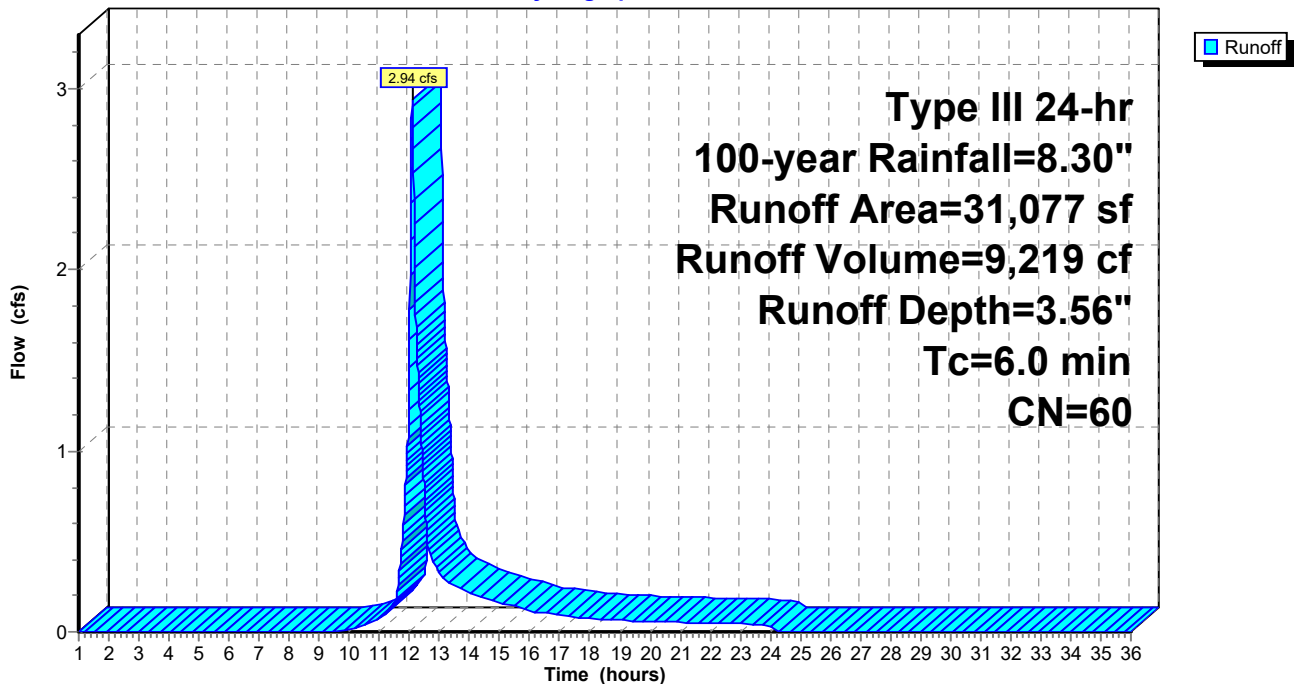



**Cole Post-Development**

Prepared by Weston & Sampson

HydroCAD® 10.10-5a s/n 00455 © 2020 HydroCAD Software Solutions LLC

Type III 24-hr 100-year Rainfall=8.30"

Printed 7/12/2021

Page 109

**Summary for Subcatchment A8: SUB-A8**

Runoff = 5.23 cfs @ 12.11 hrs, Volume= 16,986 cf, Depth= 4.49"

Runoff by SCS TR-20 method, UH=SCS, Weighted-CN, Time Span= 1.00-36.00 hrs, dt= 0.01 hrs  
Type III 24-hr 100-year Rainfall=8.30"

Area (sf)	CN	Description
* 9,176	98	Paved Impervious, HSG A
* 1,528	98	Paved Impervious, HSG B
3,894	98	Roofs, HSG A
8,917	98	Roofs, HSG B
12,216	39	>75% Grass cover, Good, HSG A
9,682	30	Woods, Good, HSG A
45,413	68	Weighted Average
21,898		48.22% Pervious Area
23,515		51.78% Impervious Area

Tc (min)	Length (feet)	Slope (ft/ft)	Velocity (ft/sec)	Capacity (cfs)	Description
6.4	50	0.1000	0.13		<b>Sheet Flow,</b> Woods: Light underbrush n= 0.400 P2= 3.30"
0.7	52	0.0570	1.19		<b>Shallow Concentrated Flow,</b> Woodland Kv= 5.0 fps
0.3	34	0.0580	1.69		<b>Shallow Concentrated Flow,</b> Short Grass Pasture Kv= 7.0 fps
7.4	136	Total			

**Cole Post-Development**

Prepared by Weston & Sampson

HydroCAD® 10.10-5a s/n 00455 © 2020 HydroCAD Software Solutions LLC

Type III 24-hr 100-year Rainfall=8.30"

Printed 7/12/2021

Page 110

**Subcatchment A8: SUB-A8**

Hydrograph

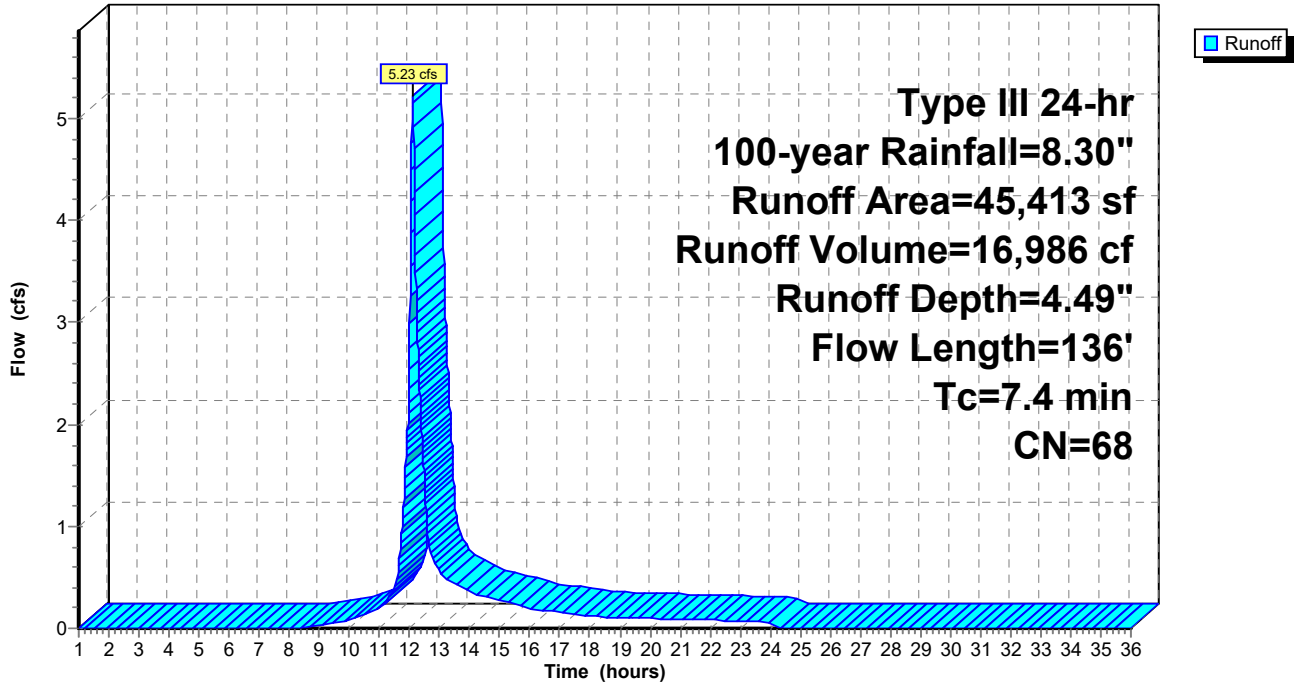

# Cole Post-Development

Prepared by Weston & Sampson

HydroCAD® 10.10-5a s/n 00455 © 2020 HydroCAD Software Solutions LLC

Type III 24-hr 100-year Rainfall=8.30"

Printed 7/12/2021

Page 111

## Summary for Subcatchment B1: SUB-B1

Runoff = 0.56 cfs @ 12.09 hrs, Volume= 1,752 cf, Depth= 3.56"

Runoff by SCS TR-20 method, UH=SCS, Weighted-CN, Time Span= 1.00-36.00 hrs, dt= 0.01 hrs  
Type III 24-hr 100-year Rainfall=8.30"

Area (sf)	CN	Description
5,112	61	>75% Grass cover, Good, HSG B
795	55	Woods, Good, HSG B
5,907	60	Weighted Average
5,907		100.00% Pervious Area

Tc (min)	Length (feet)	Slope (ft/ft)	Velocity (ft/sec)	Capacity (cfs)	Description
6.0					Direct Entry,

## Subcatchment B1: SUB-B1

Hydrograph

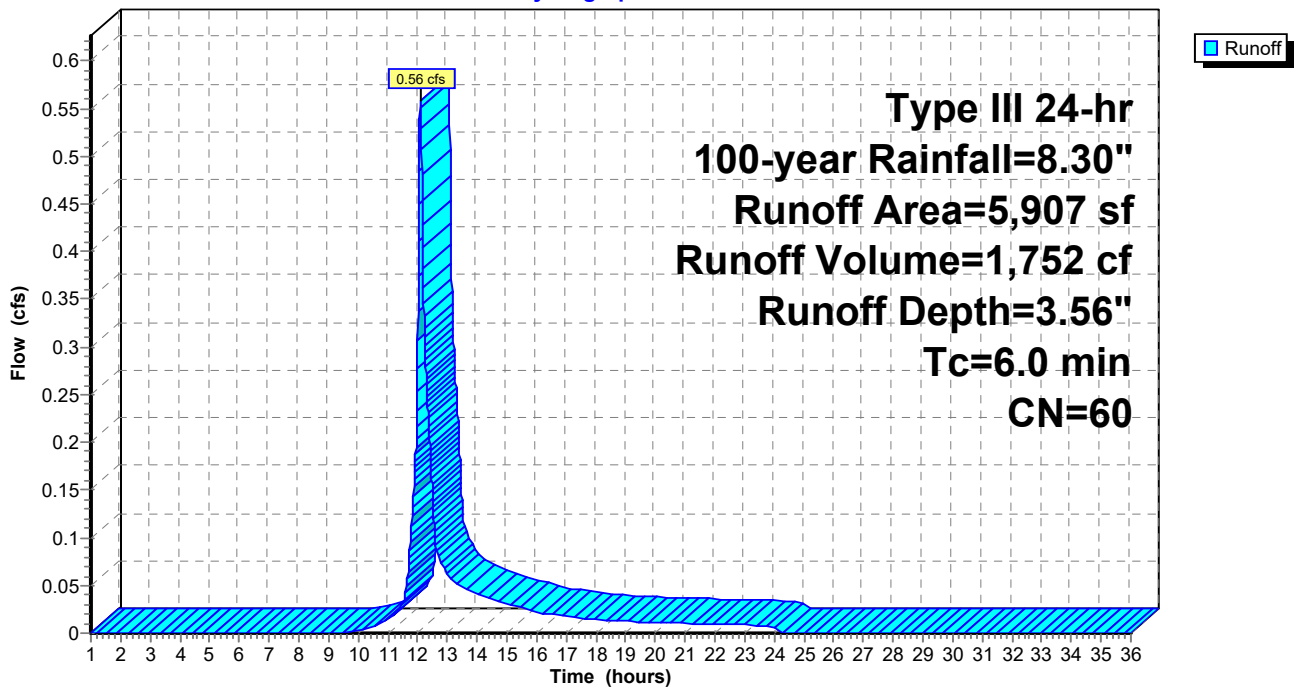

# Cole Post-Development

Prepared by Weston & Sampson

HydroCAD® 10.10-5a s/n 00455 © 2020 HydroCAD Software Solutions LLC

Type III 24-hr 100-year Rainfall=8.30"

Printed 7/12/2021

Page 112

## Summary for Pond A: POI-A

Inflow Area = 296,839 sf, 54.99% Impervious, Inflow Depth = 4.64" for 100-year event  
Inflow = 31.24 cfs @ 12.14 hrs, Volume= 114,672 cf  
Primary = 31.24 cfs @ 12.14 hrs, Volume= 114,672 cf, Atten= 0%, Lag= 0.0 min

Routing by Dyn-Stor-Ind method, Time Span= 1.00-36.00 hrs, dt= 0.01 hrs

### Pond A: POI-A

Hydrograph

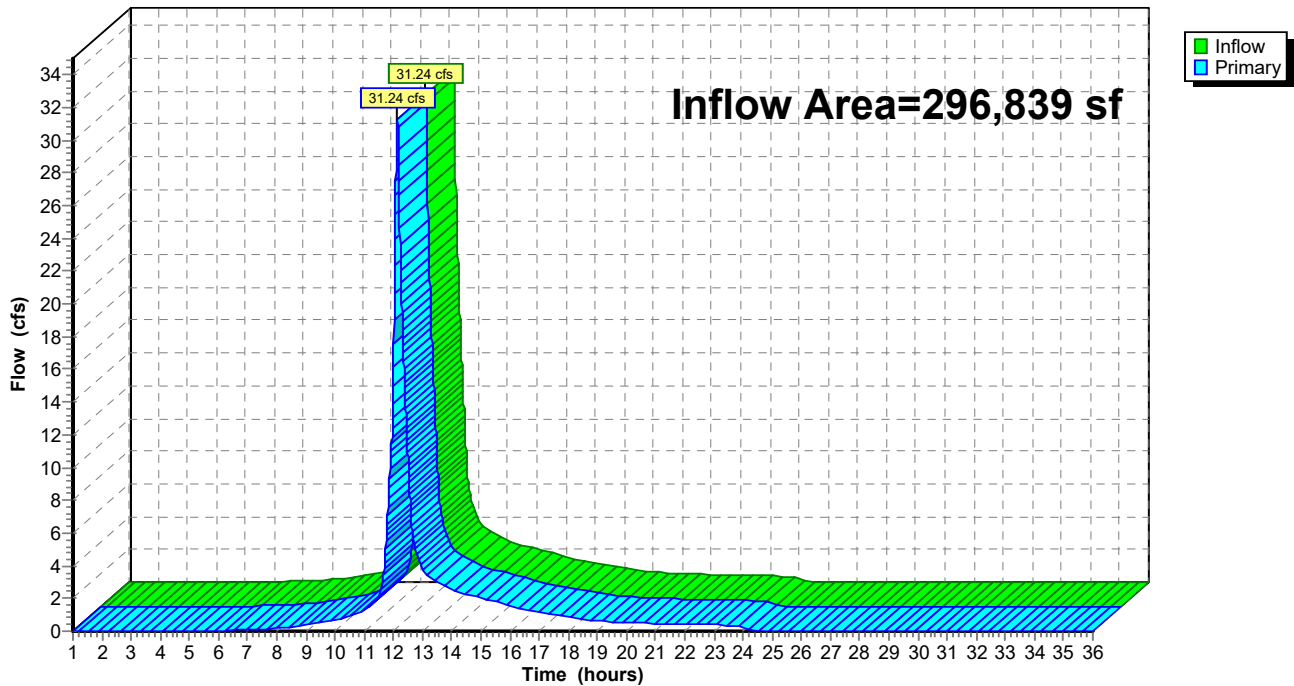

# Cole Post-Development

Prepared by Weston & Sampson

HydroCAD® 10.10-5a s/n 00455 © 2020 HydroCAD Software Solutions LLC

Type III 24-hr 100-year Rainfall=8.30"

Printed 7/12/2021

Page 113

## Summary for Pond B: POI-B

Inflow Area = 5,907 sf, 0.00% Impervious, Inflow Depth = 3.56" for 100-year event  
Inflow = 0.56 cfs @ 12.09 hrs, Volume= 1,752 cf  
Primary = 0.56 cfs @ 12.09 hrs, Volume= 1,752 cf, Atten= 0%, Lag= 0.0 min

Routing by Dyn-Stor-Ind method, Time Span= 1.00-36.00 hrs, dt= 0.01 hrs

### Pond B: POI-B

Hydrograph

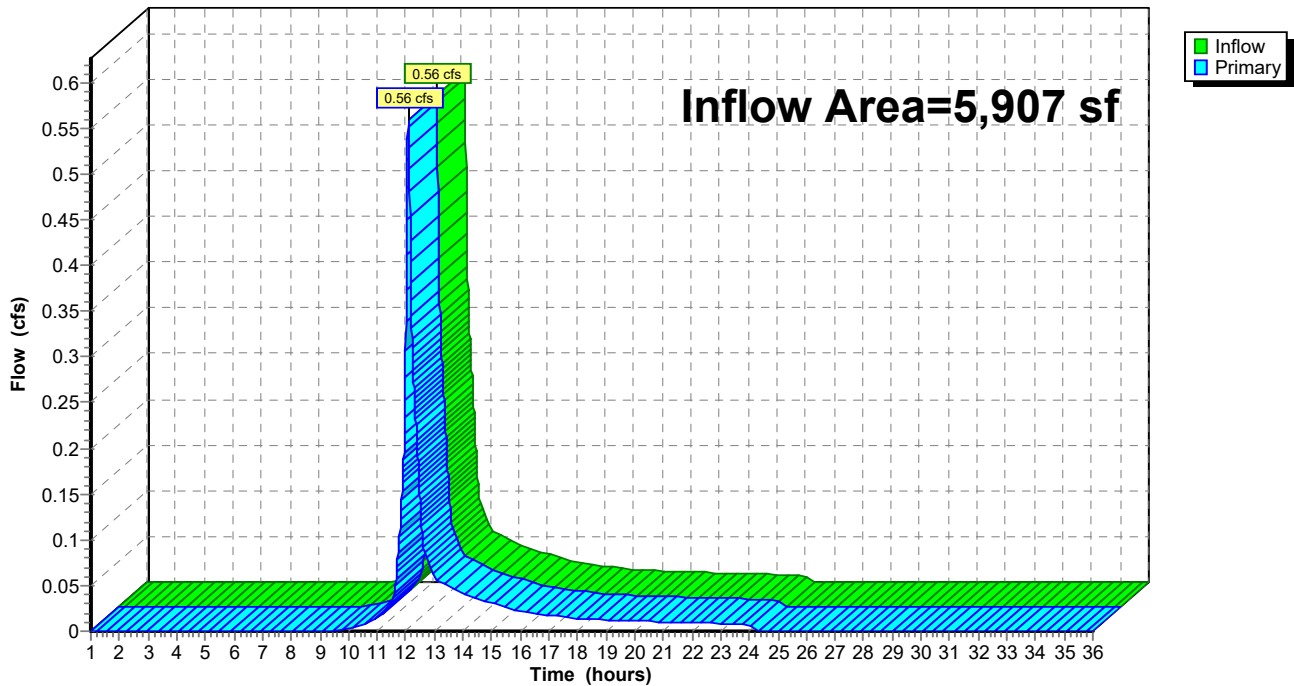

**Cole Post-Development**

Type III 24-hr 100-year Rainfall=8.30"

Prepared by Weston & Sampson

Printed 7/12/2021

HydroCAD® 10.10-5a s/n 00455 © 2020 HydroCAD Software Solutions LLC

Page 114

**Summary for Pond BR-1: BR-1**

Inflow Area = 16,500 sf, 77.45% Impervious, Inflow Depth = 6.62" for 100-year event  
 Inflow = 2.81 cfs @ 12.08 hrs, Volume= 9,106 cf  
 Outflow = 2.79 cfs @ 12.09 hrs, Volume= 8,296 cf, Atten= 1%, Lag= 0.4 min  
 Primary = 1.08 cfs @ 11.97 hrs, Volume= 7,176 cf  
 Secondary = 1.80 cfs @ 12.10 hrs, Volume= 1,120 cf

Routing by Dyn-Stor-Ind method, Time Span= 1.00-36.00 hrs, dt= 0.01 hrs  
 Peak Elev= 101.38' @ 12.10 hrs Surf.Area= 491 sf Storage= 1,037 cf

Plug-Flow detention time= 72.2 min calculated for 8,293 cf (91% of inflow)  
 Center-of-Mass det. time= 27.6 min ( 814.2 - 786.6 )

Volume	Invert	Avail.Storage	Storage Description	
#1	96.74'	1,245 cf	<b>Custom Stage Data (Prismatic)</b> Listed below (Recalc)	
Elevation (feet)	Surf.Area (sq-ft)	Voids (%)	Inc.Store (cubic-feet)	Cum.Store (cubic-feet)
96.74	641	0.0	0	0
96.75	641	40.0	3	3
97.24	641	40.0	126	128
97.25	641	30.0	2	130
100.24	641	30.0	575	705
100.25	641	40.0	3	708
100.49	641	40.0	62	769
100.50	88	100.0	4	773
101.00	335	100.0	106	879
101.75	641	100.0	366	1,245

Device	Routing	Invert	Outlet Devices
#1	Device 2	100.75'	<b>24.0" Horiz. Orifice/Grate</b> C= 0.600 Limited to weir flow at low heads
#2	Primary	94.49'	<b>12.0" Round Culvert</b> L= 62.8' CPP, projecting, no headwall, Ke= 0.900 Inlet / Outlet Invert= 94.49' / 94.18' S= 0.0049 '/' Cc= 0.900 n= 0.130, Flow Area= 0.79 sf
#3	Secondary	101.25'	<b>15.0' long x 10.0' breadth Broad-Crested Rectangular Weir</b> Head (feet) 0.20 0.40 0.60 0.80 1.00 1.20 1.40 1.60 Coef. (English) 2.49 2.56 2.70 2.69 2.68 2.69 2.67 2.64

**Primary OutFlow** Max=1.07 cfs @ 11.97 hrs HW=100.99' TW=95.24' (Dynamic Tailwater)

↑ **2=Culvert** (Outlet Controls 1.07 cfs @ 1.36 fps)

↑ **1=Orifice/Grate** (Passes 1.07 cfs of 2.40 cfs potential flow)

**Secondary OutFlow** Max=1.80 cfs @ 12.10 hrs HW=101.38' TW=96.72' (Dynamic Tailwater)

↑ **3=Broad-Crested Rectangular Weir** (Weir Controls 1.80 cfs @ 0.91 fps)

# Cole Post-Development

Prepared by Weston & Sampson

HydroCAD® 10.10-5a s/n 00455 © 2020 HydroCAD Software Solutions LLC

Type III 24-hr 100-year Rainfall=8.30"

Printed 7/12/2021

Page 115

## Pond BR-1: BR-1

Hydrograph

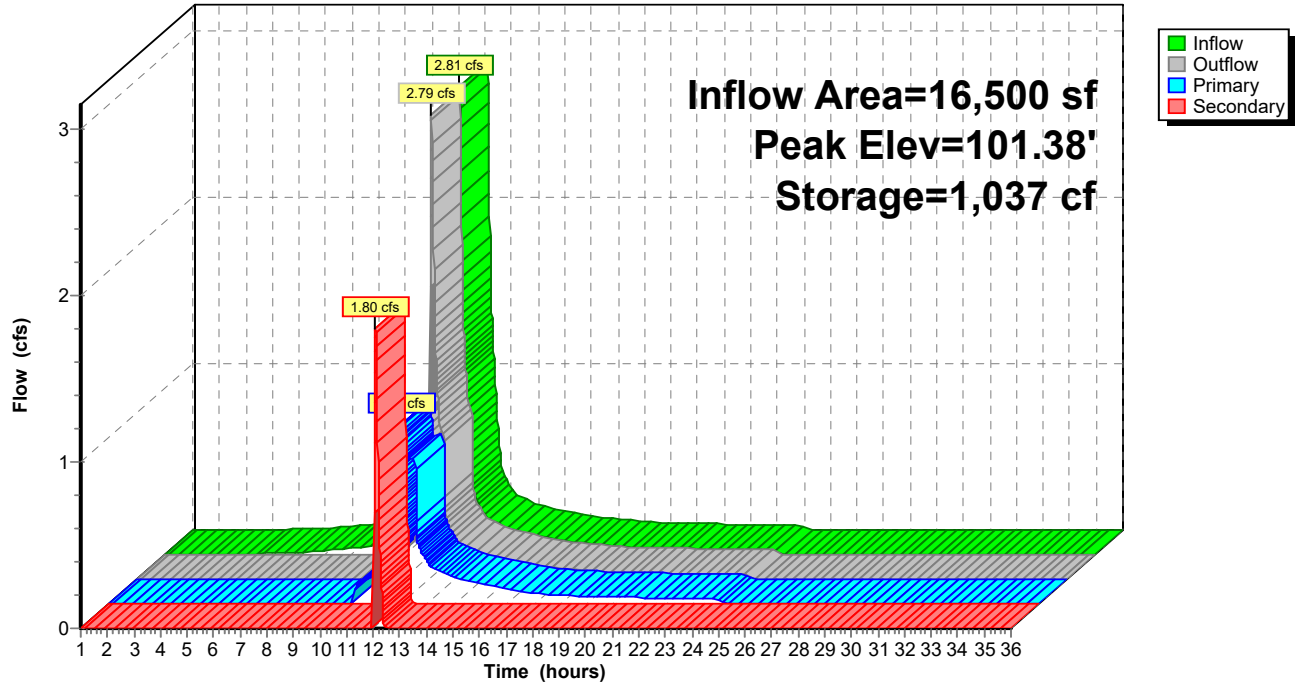

# Cole Post-Development

Prepared by Weston & Sampson

HydroCAD® 10.10-5a s/n 00455 © 2020 HydroCAD Software Solutions LLC

Type III 24-hr 100-year Rainfall=8.30"

Printed 7/12/2021

Page 116

## Summary for Pond DS-1: DS-1

Inflow Area = 35,193 sf, 61.85% Impervious, Inflow Depth = 5.55" for 100-year event  
 Inflow = 4.72 cfs @ 12.12 hrs, Volume= 16,277 cf  
 Outflow = 4.70 cfs @ 12.13 hrs, Volume= 16,277 cf, Atten= 0%, Lag= 0.5 min  
 Primary = 4.70 cfs @ 12.13 hrs, Volume= 16,277 cf

Routing by Dyn-Stor-Ind method, Time Span= 1.00-36.00 hrs, dt= 0.01 hrs  
 Peak Elev= 90.44' @ 12.13 hrs Surf.Area= 658 sf Storage= 946 cf

Plug-Flow detention time= 16.9 min calculated for 16,277 cf (100% of inflow)  
 Center-of-Mass det. time= 16.8 min ( 827.8 - 811.0 )

Volume	Invert	Avail.Storage	Storage Description
#1A	88.25'	627 cf	<b>20.50'W x 32.10'L x 3.50'H Field A</b> 2,303 cf Overall - 735 cf Embedded = 1,568 cf x 40.0% Voids
#2A	88.75'	735 cf	<b>ADS_StormTech SC-740 +Cap</b> x 16 Inside #1 Effective Size= 44.6"W x 30.0"H => 6.45 sf x 7.12'L = 45.9 cf Overall Size= 51.0"W x 30.0"H x 7.56'L with 0.44' Overlap 16 Chambers in 4 Rows
		1,362 cf	Total Available Storage

Storage Group A created with Chamber Wizard

Device	Routing	Invert	Outlet Devices
#1	Primary	88.25'	<b>24.0" Round Culvert</b> L= 26.9' CPP, projecting, no headwall, Ke= 0.900 Inlet / Outlet Invert= 88.25' / 88.12' S= 0.0048 '/' Cc= 0.900 n= 0.013 Corrugated PE, smooth interior, Flow Area= 3.14 sf
#2	Device 1	89.95'	<b>4.0' long Sharp-Crested Rectangular Weir</b> 2 End Contraction(s)
#3	Device 1	88.25'	<b>3.0" Vert. Orifice/Grate</b> C= 0.600 Limited to weir flow at low heads

**Primary OutFlow** Max=4.69 cfs @ 12.13 hrs HW=90.44' TW=0.00' (Dynamic Tailwater)

- ↑ **1=Culvert** (Passes 4.69 cfs of 12.40 cfs potential flow)
- ↑ **2=Sharp-Crested Rectangular Weir** (Weir Controls 4.36 cfs @ 2.29 fps)
- ↑ **3=Orifice/Grate** (Orifice Controls 0.34 cfs @ 6.92 fps)



**Cole Post-Development**

Prepared by Weston & Sampson

HydroCAD® 10.10-5a s/n 00455 © 2020 HydroCAD Software Solutions LLC

Type III 24-hr 100-year Rainfall=8.30"

Printed 7/12/2021

Page 117

**Pond DS-1: DS-1 - Chamber Wizard Field A**

**Chamber Model = ADS\_StormTechSC-740 +Cap (ADS StormTech®SC-740 with cap length)**

Effective Size= 44.6"W x 30.0"H => 6.45 sf x 7.12'L = 45.9 cf

Overall Size= 51.0"W x 30.0"H x 7.56'L with 0.44' Overlap

51.0" Wide + 6.0" Spacing = 57.0" C-C Row Spacing

4 Chambers/Row x 7.12' Long +0.81' Cap Length x 2 = 30.10' Row Length +12.0" End Stone x 2 = 32.10' Base Length

4 Rows x 51.0" Wide + 6.0" Spacing x 3 + 12.0" Side Stone x 2 = 20.50' Base Width

6.0" Stone Base + 30.0" Chamber Height + 6.0" Stone Cover = 3.50' Field Height

16 Chambers x 45.9 cf = 735.0 cf Chamber Storage

2,302.9 cf Field - 735.0 cf Chambers = 1,567.9 cf Stone x 40.0% Voids = 627.2 cf Stone Storage

Chamber Storage + Stone Storage = 1,362.2 cf = 0.031 af

Overall Storage Efficiency = 59.2%

Overall System Size = 32.10' x 20.50' x 3.50'

16 Chambers

85.3 cy Field

58.1 cy Stone

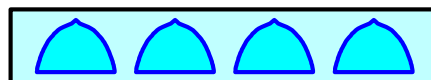
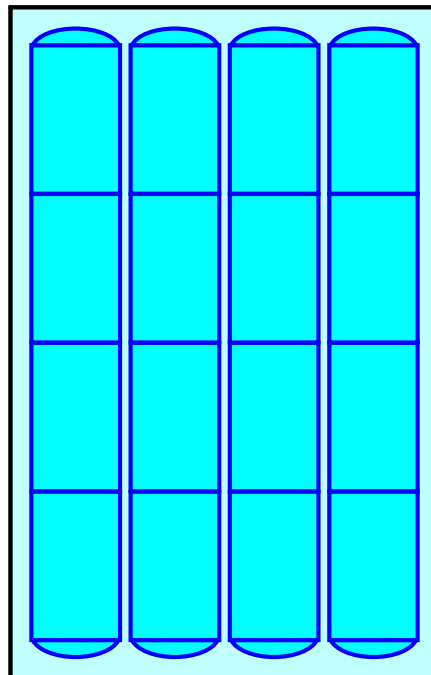

**Cole Post-Development**

Prepared by Weston & Sampson

HydroCAD® 10.10-5a s/n 00455 © 2020 HydroCAD Software Solutions LLC

Type III 24-hr 100-year Rainfall=8.30"

Printed 7/12/2021

Page 118

**Pond DS-1: DS-1**

Hydrograph

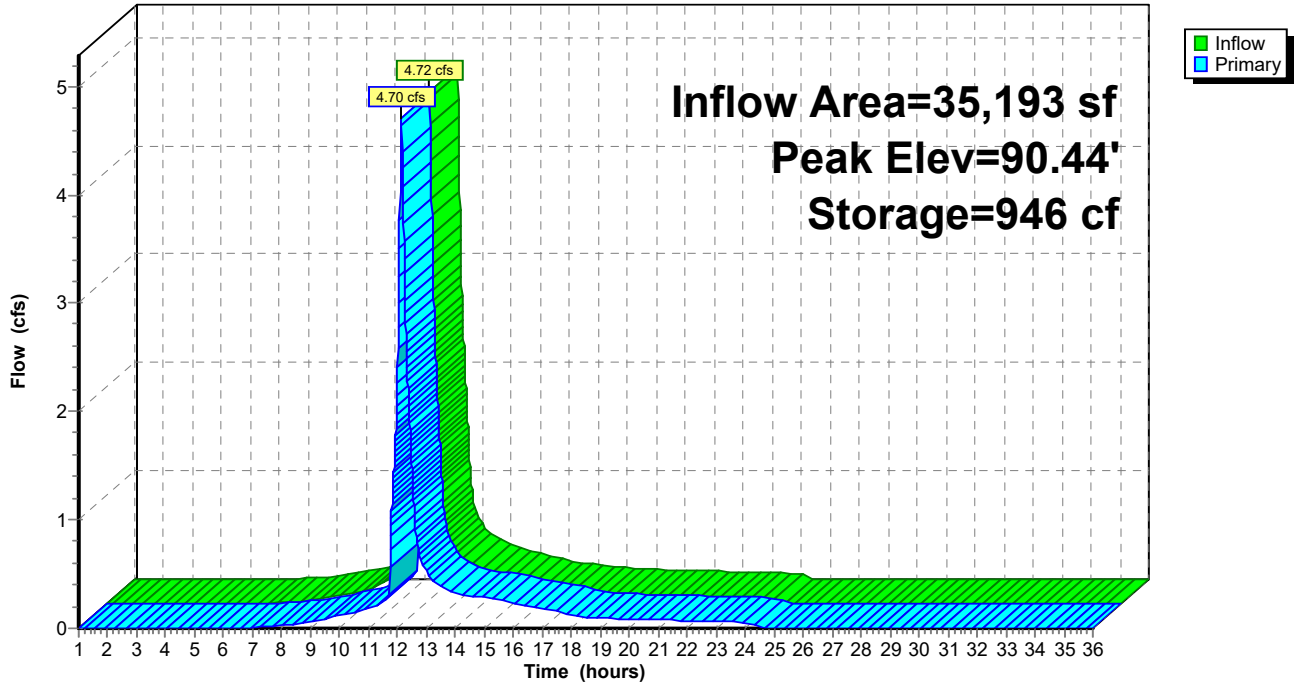

# Cole Post-Development

Prepared by Weston & Sampson

HydroCAD® 10.10-5a s/n 00455 © 2020 HydroCAD Software Solutions LLC

Type III 24-hr 100-year Rainfall=8.30"

Printed 7/12/2021

Page 119

## Summary for Pond IS-1: IS-1

Inflow Area = 61,597 sf, 85.38% Impervious, Inflow Depth = 6.99" for 100-year event  
 Inflow = 10.96 cfs @ 12.09 hrs, Volume= 35,882 cf  
 Outflow = 7.05 cfs @ 12.18 hrs, Volume= 35,882 cf, Atten= 36%, Lag= 5.6 min  
 Discarded = 0.29 cfs @ 12.18 hrs, Volume= 17,552 cf  
 Primary = 6.77 cfs @ 12.18 hrs, Volume= 18,330 cf

Routing by Dyn-Stor-Ind method, Time Span= 1.00-36.00 hrs, dt= 0.01 hrs  
 Peak Elev= 97.63' @ 12.18 hrs Surf.Area= 3,603 sf Storage= 11,693 cf

Plug-Flow detention time= 140.4 min calculated for 35,882 cf (100% of inflow)  
 Center-of-Mass det. time= 140.4 min ( 919.2 - 778.8 )

Volume	Invert	Avail.Storage	Storage Description
#1A	92.50'	5,063 cf	<b>29.92'W x 120.42'L x 5.50'H Field A</b> 19,814 cf Overall - 7,156 cf Embedded = 12,658 cf x 40.0% Voids
#2A	93.25'	7,156 cf	<b>ADS_StormTech MC-3500 d +Capx 64</b> Inside #1 Effective Size= 70.4"W x 45.0"H => 15.33 sf x 7.17'L = 110.0 cf Overall Size= 77.0"W x 45.0"H x 7.50'L with 0.33' Overlap 64 Chambers in 4 Rows Cap Storage= +14.9 cf x 2 x 4 rows = 119.2 cf
		12,219 cf	Total Available Storage

Storage Group A created with Chamber Wizard

Device	Routing	Invert	Outlet Devices
#1	Discarded	92.50'	<b>2.410 in/hr Exfiltration over Wetted area</b> Phase-In= 0.01'
#2	Primary	92.00'	<b>12.0" Round Culvert</b> L= 91.3' CPP, projecting, no headwall, Ke= 0.900 Inlet / Outlet Invert= 92.00' / 91.09' S= 0.0100 '/' Cc= 0.900 n= 0.013 Corrugated PE, smooth interior, Flow Area= 0.79 sf
#3	Device 2	97.00'	<b>4.0' long Sharp-Crested Rectangular Weir</b> 2 End Contraction(s)
#4	Device 2	94.20'	<b>4.0" Vert. Orifice/Grate</b> C= 0.600 Limited to weir flow at low heads

**Discarded OutFlow** Max=0.29 cfs @ 12.18 hrs HW=97.63' (Free Discharge)

↑ **1=Exfiltration** (Exfiltration Controls 0.29 cfs)

**Primary OutFlow** Max=6.76 cfs @ 12.18 hrs HW=97.63' TW=0.00' (Dynamic Tailwater)

↑ **2=Culvert** (Inlet Controls 6.76 cfs @ 8.61 fps)

↑ **3=Sharp-Crested Rectangular Weir** (Passes < 6.39 cfs potential flow)

↑ **4=Orifice/Grate** (Passes < 0.76 cfs potential flow)

**Cole Post-Development**

Prepared by Weston & Sampson

HydroCAD® 10.10-5a s/n 00455 © 2020 HydroCAD Software Solutions LLC

Type III 24-hr 100-year Rainfall=8.30"

Printed 7/12/2021

Page 120

**Pond IS-1: IS-1 - Chamber Wizard Field A**

**Chamber Model = ADS\_StormTechMC-3500 d +Cap (ADS StormTech®MC-3500 d rev 03/14 with Cap volume)**

Effective Size= 70.4"W x 45.0"H => 15.33 sf x 7.17'L = 110.0 cf

Overall Size= 77.0"W x 45.0"H x 7.50'L with 0.33' Overlap

Cap Storage= +14.9 cf x 2 x 4 rows = 119.2 cf

77.0" Wide + 9.0" Spacing = 86.0" C-C Row Spacing

16 Chambers/Row x 7.17' Long +1.85' Cap Length x 2 = 118.42' Row Length +12.0" End Stone x 2 = 120.42' Base Length

4 Rows x 77.0" Wide + 9.0" Spacing x 3 + 12.0" Side Stone x 2 = 29.92' Base Width

9.0" Stone Base + 45.0" Chamber Height + 12.0" Stone Cover = 5.50' Field Height

64 Chambers x 110.0 cf + 14.9 cf Cap Volume x 2 x 4 Rows = 7,156.1 cf Chamber Storage

19,814.1 cf Field - 7,156.1 cf Chambers = 12,658.0 cf Stone x 40.0% Voids = 5,063.2 cf Stone Storage

Chamber Storage + Stone Storage = 12,219.3 cf = 0.281 af

Overall Storage Efficiency = 61.7%

Overall System Size = 120.42' x 29.92' x 5.50'

64 Chambers

733.9 cy Field

468.8 cy Stone

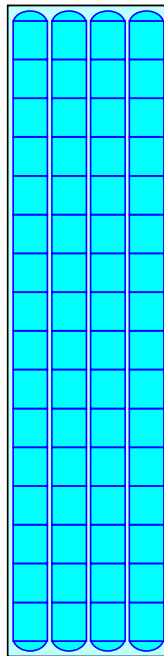

# Cole Post-Development

Prepared by Weston & Sampson

HydroCAD® 10.10-5a s/n 00455 © 2020 HydroCAD Software Solutions LLC

Type III 24-hr 100-year Rainfall=8.30"

Printed 7/12/2021

Page 121

## Pond IS-1: IS-1

Hydrograph

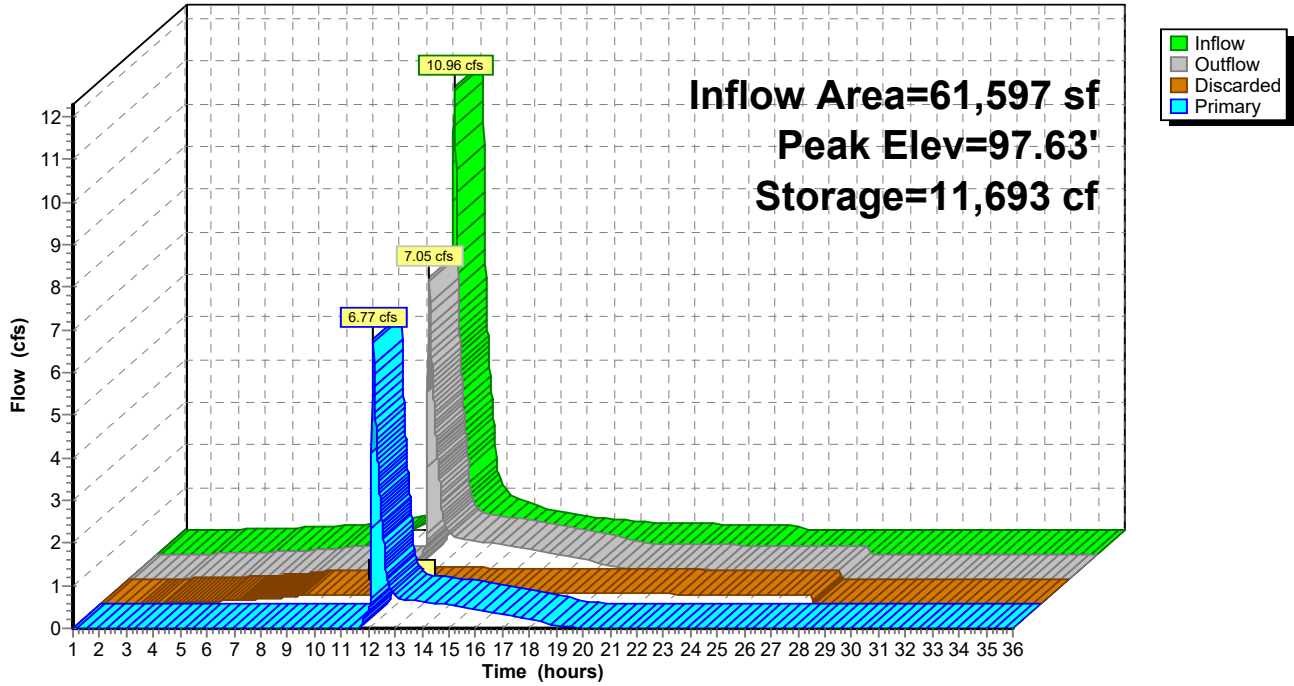

## **Attachment E - Calculations**

**INSTRUCTIONS:**

1. In BMP Column, click on Blue Cell to Activate Drop Down Menu
2. Select BMP from Drop Down Menu
3. After BMP is selected, TSS Removal and other Columns are automatically completed.

Version 1, Automated: Mar. 4, 2008

Location:

	B	C	D	E	F
	BMP <sup>1</sup>	TSS Removal Rate <sup>1</sup>	Starting TSS Load*	Amount Removed (C*D)	Remaining Load (D-E)
<b>TSS Removal Calculation Worksheet</b>	Deep Sump and Hooded Catch Basin	0.25	1.00	0.25	0.75
		0.00	0.75	0.00	0.75
		0.00	0.75	0.00	0.75
		0.00	0.75	0.00	0.75
		0.00	0.75	0.00	0.75

**Total TSS Removal =**

**Separate Form Needs to be Completed for Each Outlet or BMP Train**

Project:   
 Prepared By:   
 Date:

\*Equals remaining load from previous BMP (E) which enters the BMP

**INSTRUCTIONS:**

1. In BMP Column, click on Blue Cell to Activate Drop Down Menu
2. Select BMP from Drop Down Menu
3. After BMP is selected, TSS Removal and other Columns are automatically completed.

Version 1, Automated: Mar. 4, 2008

Location:

	B	C	D	E	F
	BMP <sup>1</sup>	TSS Removal Rate <sup>1</sup>	Starting TSS Load*	Amount Removed (C*D)	Remaining Load (D-E)
<b>TSS Removal Calculation Worksheet</b>	Deep Sump and Hooded Catch Basin	0.25	1.00	0.25	0.75
	Subsurface Infiltration Structure	0.80	0.75	0.60	0.15
		0.00	0.15	0.00	0.15
		0.00	0.15	0.00	0.15
		0.00	0.15	0.00	0.15

**Total TSS Removal =**

**Separate Form Needs to be Completed for Each Outlet or BMP Train**

Project:   
 Prepared By:   
 Date:

\*Equals remaining load from previous BMP (E) which enters the BMP



**INSTRUCTIONS:**

1. In BMP Column, click on Blue Cell to Activate Drop Down Menu
2. Select BMP from Drop Down Menu
3. After BMP is selected, TSS Removal and other Columns are automatically completed.

Version 1, Automated: Mar. 4, 2008

Location:

**TSS Removal Calculation Worksheet**

B	C	D	E	F
BMP <sup>1</sup>	TSS Removal Rate <sup>1</sup>	Starting TSS Load*	Amount Removed (C*D)	Remaining Load (D-E)
Deep Sump and Hooded Catch Basin	0.25	1.00	0.25	0.75
Bioretention Area	0.90	0.75	0.68	0.08
Subsurface Infiltration Structure	0.80	0.08	0.06	0.02
	0.00	0.02	0.00	0.02
	0.00	0.02	0.00	0.02

**Total TSS Removal =**

**Separate Form Needs to be Completed for Each Outlet or BMP Train**

Project:   
 Prepared By:   
 Date:

\*Equals remaining load from previous BMP (E) which enters the BMP

**INSTRUCTIONS:**

1. In BMP Column, click on Blue Cell to Activate Drop Down Menu
2. Select BMP from Drop Down Menu
3. After BMP is selected, TSS Removal and other Columns are automatically completed.

Version 1, Automated: Mar. 4, 2008

Location:

	B	C	D	E	F
	BMP <sup>1</sup>	TSS Removal Rate <sup>1</sup>	Starting TSS Load*	Amount Removed (C*D)	Remaining Load (D-E)
<b>TSS Removal Calculation Worksheet</b>	Deep Sump and Hooded Catch Basin	0.25	1.00	0.25	0.75
	Subsurface Infiltration Structure	0.80	0.75	0.60	0.15
		0.00	0.15	0.00	0.15
		0.00	0.15	0.00	0.15
		0.00	0.15	0.00	0.15

**Total TSS Removal =**

**Separate Form Needs to be Completed for Each Outlet or BMP Train**

Project:   
 Prepared By:   
 Date:

\*Equals remaining load from previous BMP (E) which enters the BMP

**INSTRUCTIONS:**

1. In BMP Column, click on Blue Cell to Activate Drop Down Menu
2. Select BMP from Drop Down Menu
3. After BMP is selected, TSS Removal and other Columns are automatically completed.

Version 1, Automated: Mar. 4, 2008

Location:

	B	C	D	E	F
	BMP <sup>1</sup>	TSS Removal Rate <sup>1</sup>	Starting TSS Load*	Amount Removed (C*D)	Remaining Load (D-E)
<b>TSS Removal Calculation Worksheet</b>	Deep Sump and Hooded Catch Basin	0.25	1.00	0.25	0.75
		0.00	0.75	0.00	0.75
		0.00	0.75	0.00	0.75
		0.00	0.75	0.00	0.75
		0.00	0.75	0.00	0.75

**Total TSS Removal =**

**Separate Form Needs to be Completed for Each Outlet or BMP Train**

Project:   
 Prepared By:   
 Date:

\*Equals remaining load from previous BMP (E) which enters the BMP

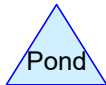
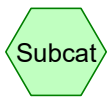
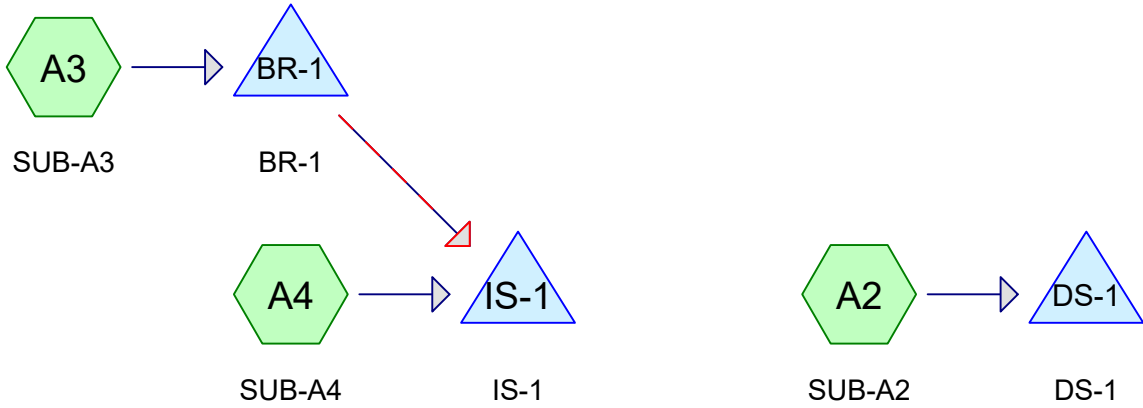

# HydroCAD-Isolator Sizing

Prepared by Weston & Sampson

HydroCAD® 10.10-5a s/n 00455 © 2020 HydroCAD Software Solutions LLC

Type III 24-hr 1" Rainfall=1.00"

Printed 7/12/2021

Page 2

## Summary for Subcatchment A2: SUB-A2

Runoff = 0.49 cfs @ 12.12 hrs, Volume= 1,753 cf, Depth= 0.50"

Runoff by SCS TR-20 method, UH=SCS, Weighted-Q, Time Span= 0.00-72.00 hrs, dt= 0.01 hrs  
Type III 24-hr 1" Rainfall=1.00"

Area (sf)	CN	Description
* 594	98	Paved Impervious, HSG A
* 19,475	98	Paved Impervious, HSG B
6,526	98	Roofs, HSG B
3,099	39	>75% Grass cover, Good, HSG A
4,693	61	>75% Grass cover, Good, HSG B
7,641	30	Woods, Good, HSG A
87	55	Woods, Good, HSG B
42,115		Weighted Average
15,520		36.85% Pervious Area
26,595		63.15% Impervious Area

Tc (min)	Length (feet)	Slope (ft/ft)	Velocity (ft/sec)	Capacity (cfs)	Description
7.4	50	0.0700	0.11		<b>Sheet Flow,</b> Woods: Light underbrush n= 0.400 P2= 3.24"
0.5	33	0.0450	1.06		<b>Shallow Concentrated Flow,</b> Woodland Kv= 5.0 fps
0.9	59	0.0250	1.11		<b>Shallow Concentrated Flow,</b> Short Grass Pasture Kv= 7.0 fps
0.1	18	0.0150	2.49		<b>Shallow Concentrated Flow,</b> Paved Kv= 20.3 fps
8.9	160	Total			

# HydroCAD-Isolator Sizing

Prepared by Weston & Sampson

HydroCAD® 10.10-5a s/n 00455 © 2020 HydroCAD Software Solutions LLC

Type III 24-hr 1" Rainfall=1.00"

Printed 7/12/2021

Page 3

## Subcatchment A2: SUB-A2

Hydrograph

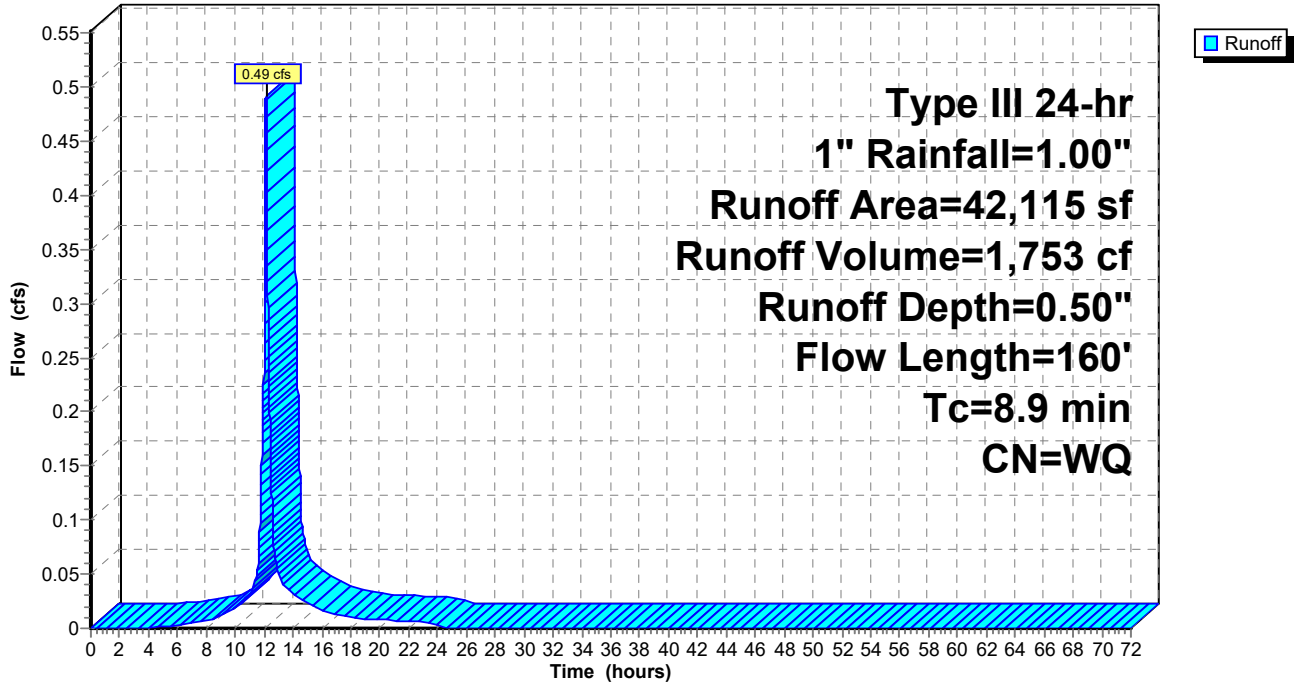

# HydroCAD-Isolator Sizing

Prepared by Weston & Sampson

HydroCAD® 10.10-5a s/n 00455 © 2020 HydroCAD Software Solutions LLC

Type III 24-hr 1" Rainfall=1.00"

Printed 7/12/2021

Page 4

## Summary for Subcatchment A3: SUB-A3

Runoff = 0.26 cfs @ 12.08 hrs, Volume= 842 cf, Depth= 0.61"

Runoff by SCS TR-20 method, UH=SCS, Weighted-Q, Time Span= 0.00-72.00 hrs, dt= 0.01 hrs  
Type III 24-hr 1" Rainfall=1.00"

	Area (sf)	CN	Description
*	4,196	98	Paved Impervious, HSG A
*	1,717	98	Paved Impervious, HSG B
	6,866	98	Roofs, HSG B
	2,808	39	>75% Grass cover, Good, HSG A
	913	61	>75% Grass cover, Good, HSG B
	16,500		Weighted Average
	3,721		22.55% Pervious Area
	12,779		77.45% Impervious Area

Tc (min)	Length (feet)	Slope (ft/ft)	Velocity (ft/sec)	Capacity (cfs)	Description
6.0					Direct Entry,

## Subcatchment A3: SUB-A3

Hydrograph

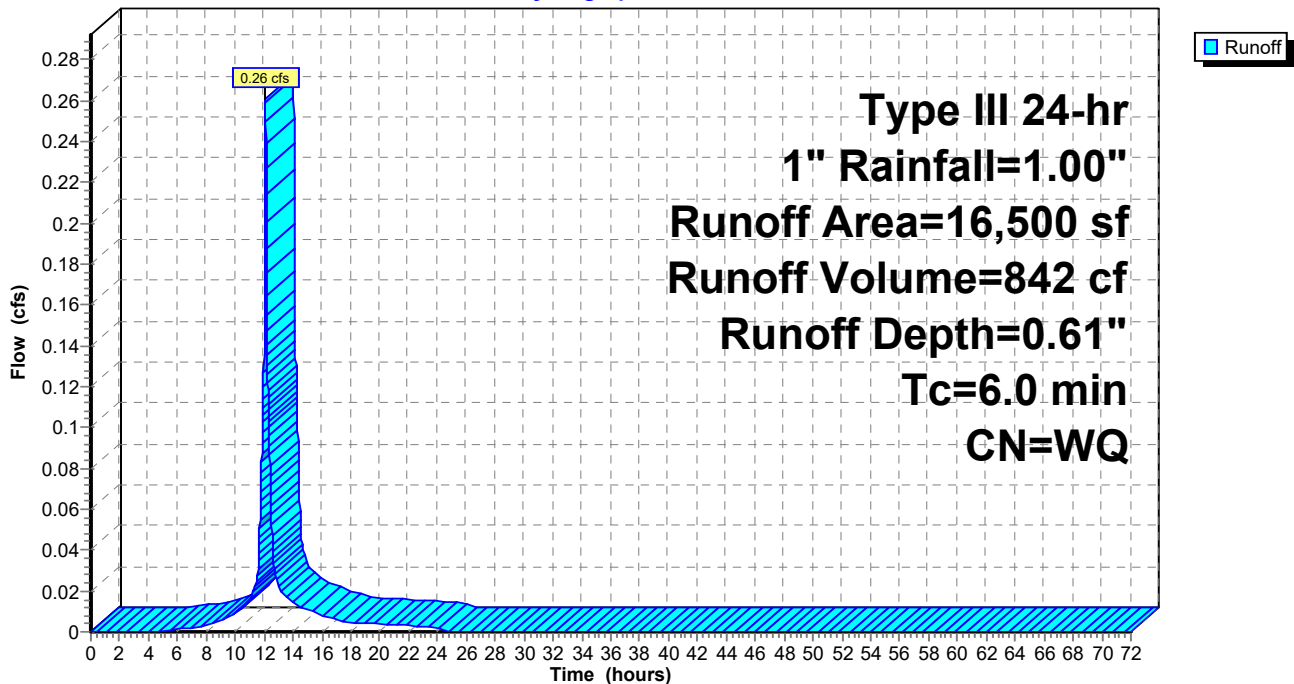

# HydroCAD-Isolator Sizing

Prepared by Weston & Sampson

HydroCAD® 10.10-5a s/n 00455 © 2020 HydroCAD Software Solutions LLC

Type III 24-hr 1" Rainfall=1.00"

Printed 7/12/2021

Page 5

## Summary for Subcatchment A4: SUB-A4

Runoff = 0.66 cfs @ 12.08 hrs, Volume= 2,115 cf, Depth= 0.70"

Runoff by SCS TR-20 method, UH=SCS, Weighted-Q, Time Span= 0.00-72.00 hrs, dt= 0.01 hrs  
Type III 24-hr 1" Rainfall=1.00"

	Area (sf)	CN	Description
*	26,170	98	Paved Impervious, HSG A
*	2,118	98	Paved Impervious, HSG B
	2,557	98	Roofs, HSG A
	1,248	98	Roofs, HSG B
	2,569	39	>75% Grass cover, Good, HSG A
	1,695	61	>75% Grass cover, Good, HSG B
36,357			Weighted Average
4,264			11.73% Pervious Area
32,093			88.27% Impervious Area

Tc (min)	Length (feet)	Slope (ft/ft)	Velocity (ft/sec)	Capacity (cfs)	Description
6.0					Direct Entry,

## Subcatchment A4: SUB-A4

Hydrograph

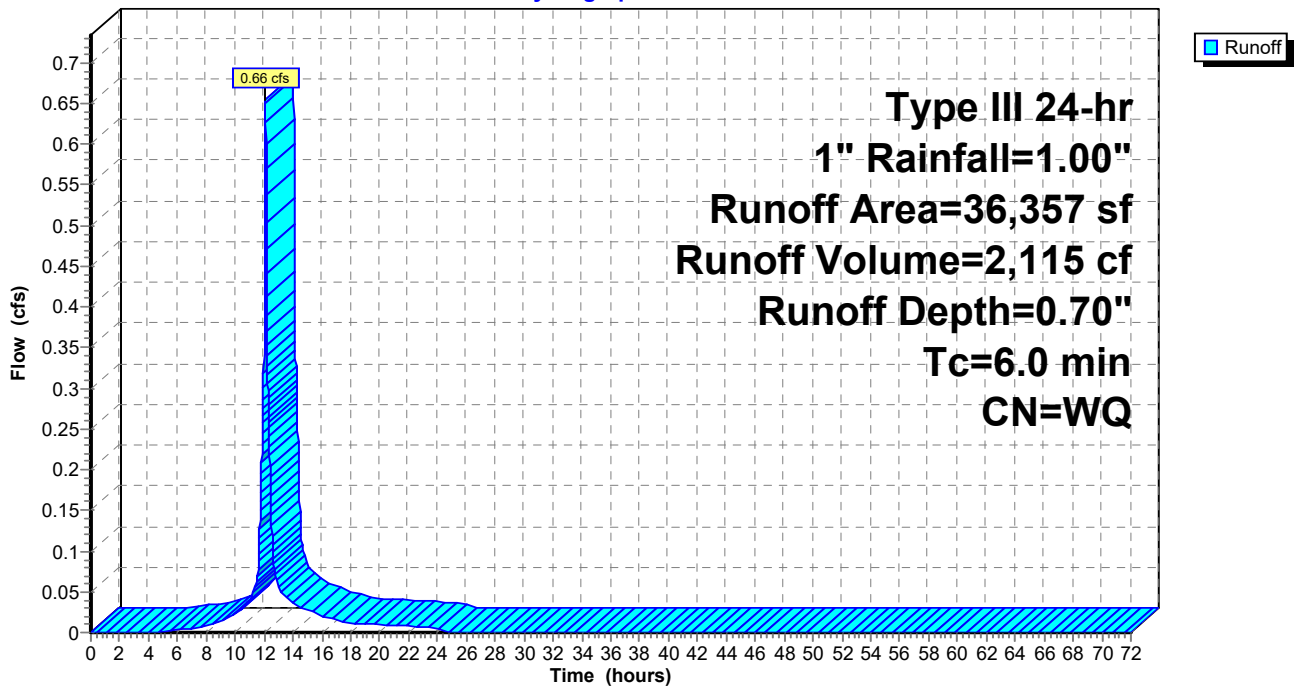



# HydroCAD-Isolator Sizing

Prepared by Weston & Sampson

HydroCAD® 10.10-5a s/n 00455 © 2020 HydroCAD Software Solutions LLC

Type III 24-hr 1" Rainfall=1.00"

Printed 7/12/2021

Page 6

## Summary for Pond BR-1: BR-1

Inflow Area = 16,500 sf, 77.45% Impervious, Inflow Depth = 0.61" for 1" event  
 Inflow = 0.26 cfs @ 12.08 hrs, Volume= 842 cf  
 Outflow = 0.00 cfs @ 21.28 hrs, Volume= 32 cf, Atten= 99%, Lag= 551.7 min  
 Primary = 0.00 cfs @ 21.28 hrs, Volume= 32 cf  
 Secondary = 0.00 cfs @ 0.00 hrs, Volume= 0 cf

Routing by Dyn-Stor-Ind method, Time Span= 0.00-72.00 hrs, dt= 0.01 hrs  
 Peak Elev= 100.75' @ 21.28 hrs Surf.Area= 213 sf Storage= 811 cf

Plug-Flow detention time= 906.4 min calculated for 32 cf (4% of inflow)  
 Center-of-Mass det. time= 564.9 min ( 1,352.8 - 787.9 )

Volume	Invert	Avail.Storage	Storage Description	
#1	96.74'	1,245 cf	<b>Custom Stage Data (Prismatic)</b> Listed below (Recalc)	
Elevation (feet)	Surf.Area (sq-ft)	Voids (%)	Inc.Store (cubic-feet)	Cum.Store (cubic-feet)
96.74	641	0.0	0	0
96.75	641	40.0	3	3
97.24	641	40.0	126	128
97.25	641	30.0	2	130
100.24	641	30.0	575	705
100.25	641	40.0	3	708
100.49	641	40.0	62	769
100.50	88	100.0	4	773
101.00	335	100.0	106	879
101.75	641	100.0	366	1,245

Device	Routing	Invert	Outlet Devices
#1	Device 2	100.75'	<b>24.0" Horiz. Orifice/Grate</b> C= 0.600 Limited to weir flow at low heads
#2	Primary	94.49'	<b>12.0" Round Culvert</b> L= 62.8' CPP, projecting, no headwall, Ke= 0.900 Inlet / Outlet Invert= 94.49' / 94.18' S= 0.0049 '/' Cc= 0.900 n= 0.130, Flow Area= 0.79 sf
#3	Secondary	101.25'	<b>15.0' long x 10.0' breadth Broad-Crested Rectangular Weir</b> Head (feet) 0.20 0.40 0.60 0.80 1.00 1.20 1.40 1.60 Coef. (English) 2.49 2.56 2.70 2.69 2.68 2.69 2.67 2.64

**Primary OutFlow** Max=0.00 cfs @ 21.28 hrs HW=100.75' TW=92.75' (Dynamic Tailwater)

↑ **2=Culvert** (Passes 0.00 cfs of 1.05 cfs potential flow)

↑ **1=Orifice/Grate** (Weir Controls 0.00 cfs @ 0.18 fps)

**Secondary OutFlow** Max=0.00 cfs @ 0.00 hrs HW=96.74' TW=92.75' (Dynamic Tailwater)

↑ **3=Broad-Crested Rectangular Weir** ( Controls 0.00 cfs)

# HydroCAD-Isolator Sizing

Prepared by Weston & Sampson

HydroCAD® 10.10-5a s/n 00455 © 2020 HydroCAD Software Solutions LLC

Type III 24-hr 1" Rainfall=1.00"

Printed 7/12/2021

Page 7

## Pond BR-1: BR-1

Hydrograph

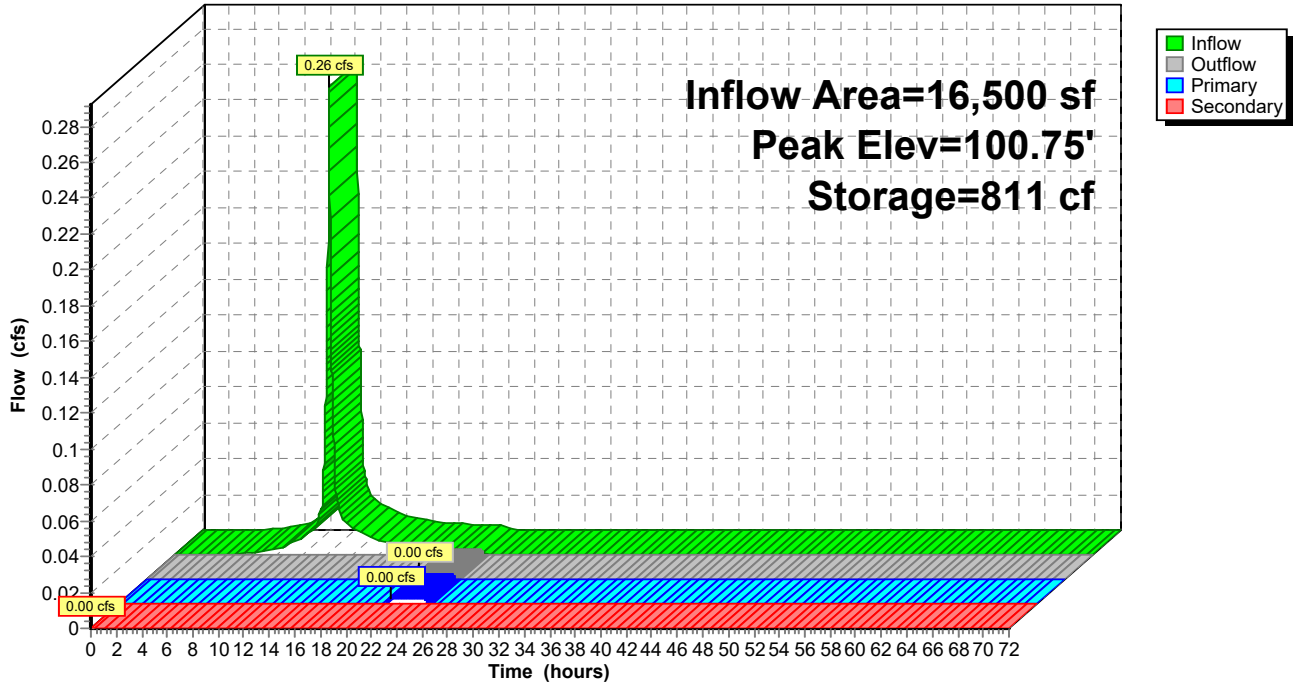

# HydroCAD-Isolator Sizing

Prepared by Weston & Sampson

HydroCAD® 10.10-5a s/n 00455 © 2020 HydroCAD Software Solutions LLC

Type III 24-hr 1" Rainfall=1.00"

Printed 7/12/2021

Page 8

## Summary for Pond DS-1: DS-1

Inflow Area = 42,115 sf, 63.15% Impervious, Inflow Depth = 0.50" for 1" event  
Inflow = 0.49 cfs @ 12.12 hrs, Volume= 1,753 cf  
Outflow = 0.23 cfs @ 12.34 hrs, Volume= 1,753 cf, Atten= 54%, Lag= 13.2 min  
Primary = 0.23 cfs @ 12.34 hrs, Volume= 1,753 cf  
Secondary = 0.00 cfs @ 0.00 hrs, Volume= 0 cf

Routing by Dyn-Stor-Ind method, Time Span= 0.00-72.00 hrs, dt= 0.01 hrs  
Peak Elev= 89.30' @ 12.34 hrs Surf.Area= 397 sf Storage= 228 cf

Plug-Flow detention time= (not calculated: outflow precedes inflow)  
Center-of-Mass det. time= 4.8 min ( 795.4 - 790.6 )

Volume	Invert	Avail.Storage	Storage Description
#1	88.75'	735 cf	<b>ADS_StormTech SC-740 +Cap x 16</b> Effective Size= 44.6"W x 30.0"H => 6.45 sf x 7.12'L = 45.9 cf Overall Size= 51.0"W x 30.0"H x 7.56'L with 0.44' Overlap

Device	Routing	Invert	Outlet Devices
#1	Primary	88.25'	<b>3.0" Vert. Orifice/Grate</b> C= 0.600 Limited to weir flow at low heads
#2	Device 1	88.75'	<b>0.20 cfs Exfiltration X 16.00 at all elevations</b> Phase-In= 0.01'
#3	Secondary	89.95'	<b>12.0" Round Culvert</b> L= 15.2' CPP, projecting, no headwall, Ke= 0.900 Inlet / Outlet Invert= 89.95' / 89.95' S= 0.0000 '/ Cc= 0.900 n= 0.013 Corrugated PE, smooth interior, Flow Area= 0.79 sf

**Primary OutFlow** Max=0.23 cfs @ 12.34 hrs HW=89.30' (Free Discharge)

↑1=**Orifice/Grate** (Orifice Controls 0.23 cfs @ 4.64 fps)

↑2=**Exfiltration** (Passes 0.23 cfs of 3.20 cfs potential flow)

**Secondary OutFlow** Max=0.00 cfs @ 0.00 hrs HW=88.75' (Free Discharge)

↑3=**Culvert** ( Controls 0.00 cfs)

# HydroCAD-Isolator Sizing

Prepared by Weston & Sampson

HydroCAD® 10.10-5a s/n 00455 © 2020 HydroCAD Software Solutions LLC

Type III 24-hr 1" Rainfall=1.00"

Printed 7/12/2021

Page 9

## Pond DS-1: DS-1

Hydrograph

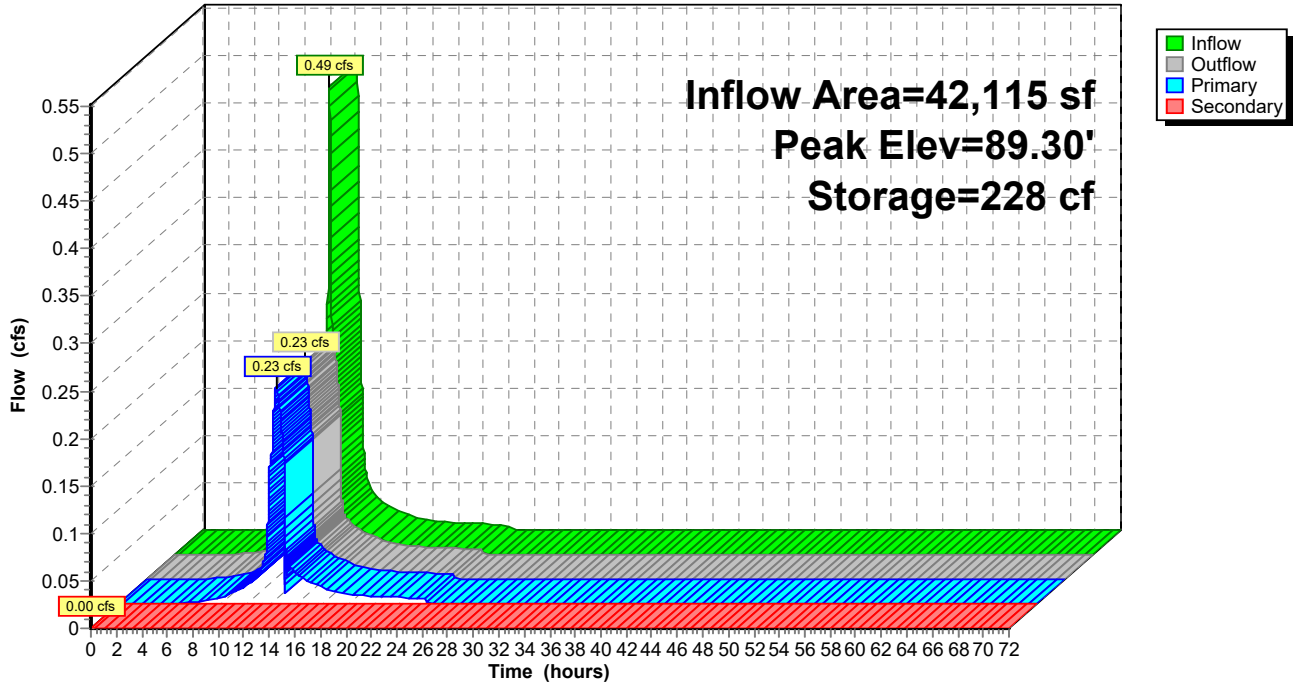

# HydroCAD-Isolator Sizing

Prepared by Weston & Sampson

HydroCAD® 10.10-5a s/n 00455 © 2020 HydroCAD Software Solutions LLC

Type III 24-hr 1" Rainfall=1.00"

Printed 7/12/2021

Page 10

## Summary for Pond IS-1: IS-1

Inflow Area = 52,857 sf, 84.89% Impervious, Inflow Depth = 0.49" for 1" event  
Inflow = 0.66 cfs @ 12.08 hrs, Volume= 2,147 cf  
Outflow = 0.66 cfs @ 12.08 hrs, Volume= 2,147 cf, Atten= 0%, Lag= 0.0 min  
Primary = 0.66 cfs @ 12.08 hrs, Volume= 2,147 cf  
Secondary = 0.00 cfs @ 0.00 hrs, Volume= 0 cf

Routing by Dyn-Stor-Ind method, Time Span= 0.00-72.00 hrs, dt= 0.01 hrs

Peak Elev= 92.75' @ 0.00 hrs Surf.Area= 685 sf Storage= 0 cf

Plug-Flow detention time= (not calculated: outflow precedes inflow)

Center-of-Mass det. time= 0.0 min ( 796.3 - 796.3 )

Volume	Invert	Avail.Storage	Storage Description
#1	92.75'	1,789 cf	<b>ADS_StormTech MC-3500 d +Cap x 16</b> Effective Size= 70.4"W x 45.0"H => 15.33 sf x 7.17'L = 110.0 cf Overall Size= 77.0"W x 45.0"H x 7.50'L with 0.33' Overlap Cap Storage= +14.9 cf x 2 x 1 rows = 29.8 cf

Device	Routing	Invert	Outlet Devices
#1	Primary	92.75'	<b>0.30 cfs Exfiltration X 16.00 at all elevations</b> Phase-In= 0.01'
#2	Secondary	93.50'	<b>12.0" Round Culvert</b> L= 24.5' CPP, projecting, no headwall, Ke= 0.900 Inlet / Outlet Invert= 93.50' / 93.50' S= 0.0000 '/ Cc= 0.900 n= 0.013 Corrugated PE, smooth interior, Flow Area= 0.79 sf

**Primary OutFlow** Max=0.00 cfs @ 12.08 hrs HW=92.75' (Free Discharge)

↳ **1=Exfiltration** (Passes 0.00 cfs of 4.80 cfs potential flow)

**Secondary OutFlow** Max=0.00 cfs @ 0.00 hrs HW=92.75' (Free Discharge)

↳ **2=Culvert** ( Controls 0.00 cfs)

# HydroCAD-Isolator Sizing

Prepared by Weston & Sampson

HydroCAD® 10.10-5a s/n 00455 © 2020 HydroCAD Software Solutions LLC

Type III 24-hr 1" Rainfall=1.00"

Printed 7/12/2021

Page 11

## Pond IS-1: IS-1

Hydrograph

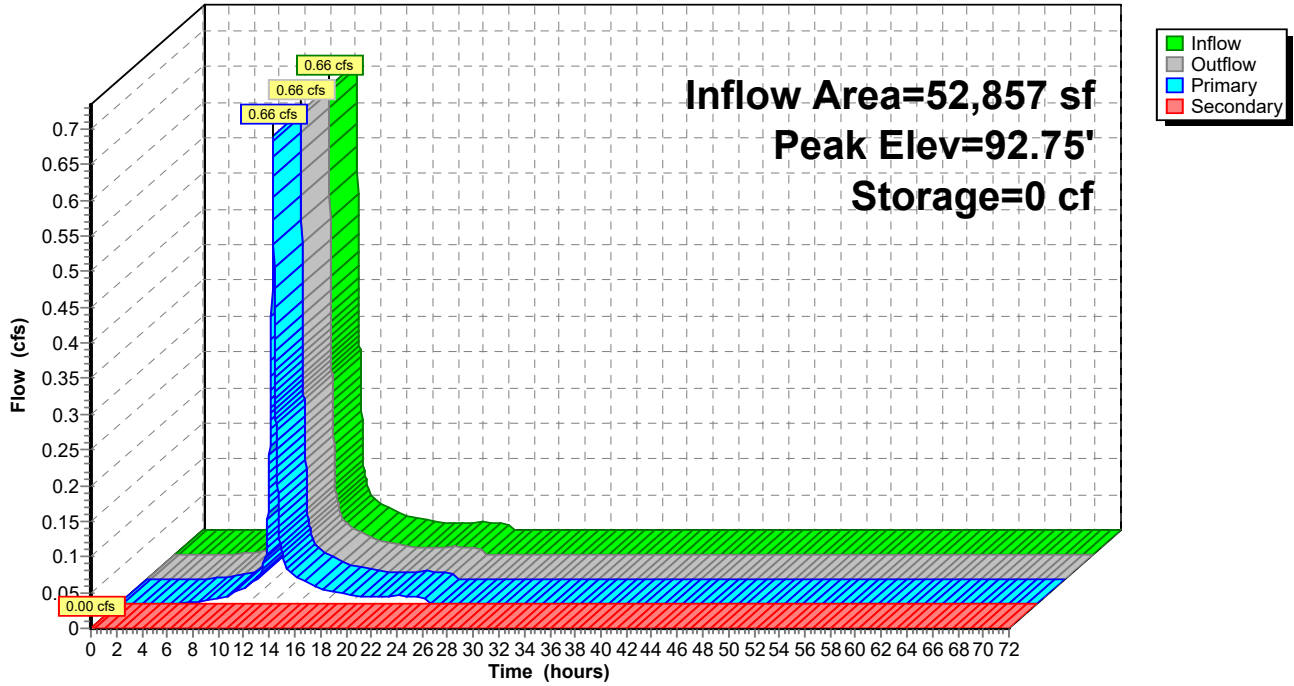



PAUL R. LEPAGE  
GOVERNOR

STATE OF MAINE  
DEPARTMENT OF  
ENVIRONMENTAL PROTECTION



PAUL MERCER  
COMMISSIONER

July 29, 2016

StormTech, A Division of ADS, Inc.  
70 Inwood Road, Suite 3  
Rocky Hill, CT 06067  
ATTN: David Mailhot P.E.

Dear Mr. Mailhot,

This letter replaces the letter dated March 22, 2016. It includes a slight modification in section 1 to clarify sizing requirements.

The Stormtech Isolator Row was approved by the Department of Environmental Protection (Department) in September 2009 for use as a pre-treatment row before a subsurface underdrained filter system as described in Chapter 7.3 of Volume III of the Maine Stormwater Management Best Management Practice Manual. The sizing, installation, and maintenance criteria provided in this letter replace the ones given in Chapter 7.3 of Volume III of the Maine Stormwater Management BMP Manual. The Department still authorizes the use of the StormTech Isolator Row as a pre-treatment row meeting the requirements of the General Standards (Section 4.C.) of the Stormwater Management Rules (Chapter 500) provided the system is sized, installed, and maintained in accordance with the following provisions:

1. The number of chambers within the Isolator Row pre-treatment structure must treat, without overflowing, the one-year 24-hour peak flow from the structure's drainage area. To determine the number of chambers, the one-year peak flow rate must be divided by the specific flow rate of the chamber. The acceptable flow rate for each of the Isolator Row chamber sizes are as follow:

Chamber size	Flow Rate
SC-310	0.1 cfs
SC-740 or DC-780	0.2 cfs
MC-3500	0.3 cfs

Additional pre-treatment rows may be added based on site conditions and chamber bed layout provided each row is provided with access manhole and control structures.

2. The Isolator Row must be part of a stormwater management system that conforms to all the requirements of Chapter 7.3 of the Stormwater Management Manual and be fitted with an overflow that bypasses the pretreatment Isolator Row only when the one-year 24-hour peak flow is exceeded, and discharges to a stable outlet or is directed to a detention system/structure that will provide necessary flood storage.
3. The Isolator Row shall be underlain with a bottom surface consisting of two layers of ADS 315 woven geotextile or equivalent; and be covered with one layer of ADS 601T non-woven geotextile or equivalent.
4. The Isolator Row does not provide for the removal of hydrocarbons and should be preceded by a device or practice that will serve this function if the area draining to the Isolator Row is

AUGUSTA  
17 STATE HOUSE STATION  
AUGUSTA, MAINE 04333-0017  
(207) 287-7688 FAX: (207) 287-7826

BANGOR  
106 HOGAN ROAD, SUITE 6  
BANGOR, MAINE 04401  
(207) 941-4570 FAX: (207) 941-4584

PORTLAND  
312 CANCO ROAD  
PORTLAND, MAINE 04103  
(207) 822-6300 FAX: (207) 822-6303

PRESQUE ISLE  
1235 CENTRAL DRIVE, SKYWAY PARK  
PRESQUE ISLE, MAINE 04769  
(207) 764-0477 FAX: (207) 760-3143

web site: [www.maine.gov/dep](http://www.maine.gov/dep)

a likely source of hydrocarbons (i.e. parking lots, roads, drive-through commercial enterprises).

5. The Isolator Row must include an access at both ends for the removal of accumulated sediment and debris.
6. The first year of system maintenance must be provided by the manufacturer to ensure that the system is operating according to the established specifications.
7. Prior to construction, a five-year binding inspection and maintenance contract must be provided for review and approval by the Department, and must be renewed before contract expiration. The contract will be with a professional with knowledge of erosion and stormwater control, including a detailed working knowledge of the proposed system.
8. The overall stormwater management design must meet all Department criteria and sizing specifications and will be reviewed and approved by the Department prior to use.
9. Each project must be reviewed and approved by the manufacturer for proposed use, layout and sizing of the pre-treatment row and for conformance with their design specifications.
10. The pre-treatment row must be installed under the manufacturer's representative supervision.
11. This approval is conditional to on-the-ground experience confirming that the StormTech Isolator Row system's pollutant removal efficiency is appropriate. The "permit shield" provision (Section 14) of the Chapter 500 rules will apply, and the Department will not require the replacement of the system if, with proper maintenance, pollutant removals do not satisfy the General Standard Best Management Practices.

We look forward to working with you as these stormwater management structures are installed on new projects. Questions concerning this decision should be directed to Marianne Hubert at (207) 215-6485 or Jeff Dennis at (207) 215-6376.

Sincerely,

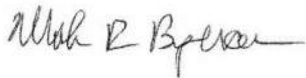

Mark Bergeron, P.E.  
Director  
Bureau of Land Resources

Cc: Don Witherill, Maine DEP  
Gregg Novick, Stormwater Compliance LLC  
John Whitehouse, Advanced Drainage Systems, Inc.



# StormTech and Stormwater Quality

StormTech's patented Isolator™ Row is a row of chambers wrapped in a geotextile which filters the stormwater trapping pollutants in the row. The Isolator Row provides a way to inspect and maintain the system.

## Isolator Row Detail

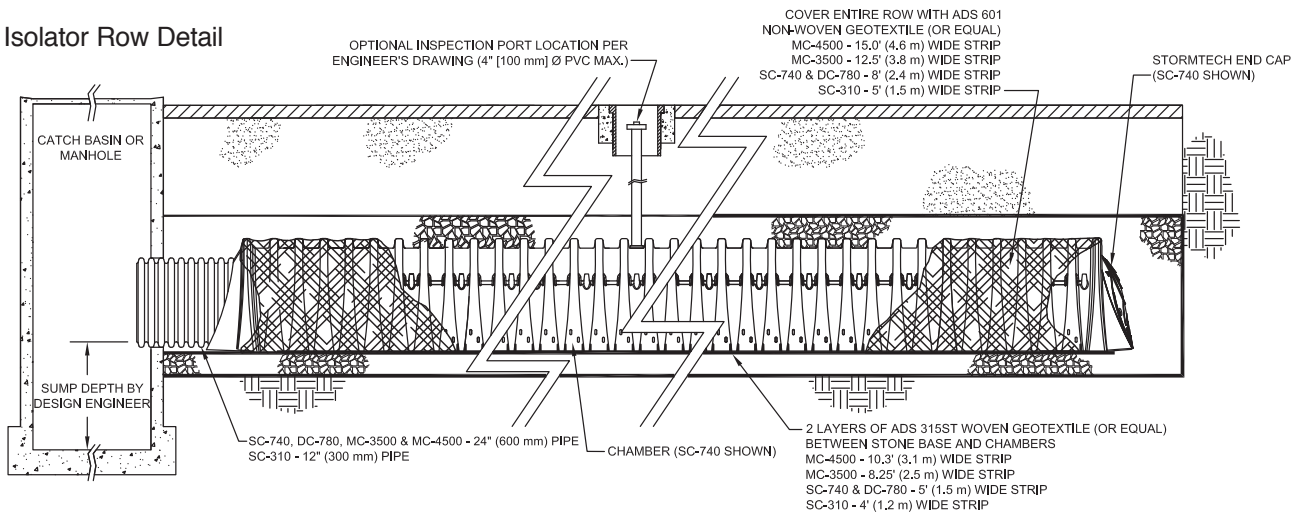

**Note:** For many applications, the non-woven geotextile over the DC-780, MC-3500 and MC-4500 Isolator Row chambers can be eliminated or substituted with the AASHTO Class 1 woven geotextile. Contact your StormTech representative for assistance.

## Isolator Row Field Verification Testing at the University of New Hampshire Stormwater Center

- Field testing (TARP tier II protocol) of the Isolator Row has been ongoing since December 2006.
- Removal efficiencies for TSS have improved as the filter cake has built up on the bottom fabric of the Isolator Row.
- Current data shows a TSS removal efficiency which exceeds 80%.

### Removal Efficiency Results:

- Total Suspended Solids = 80%
- Phosphorous = 49%
- Total Petroleum Hydrocarbons = 90%
- Zinc = 53%

This system achieves a removal efficiency of 80% for TSS which meets most municipal recommended levels for water quality treatment.



### Inspection and Maintenance

The Isolator Row can be inspected through the upstream manhole or optional inspection port.

Maintenance is easily accomplished with the JetVac process.

The frequency of inspection and maintenance varies by location. Contact StormTech for assistance with inspection and maintenance scheduling.



**Technical Memo**

Pages: 3

To: Ed Pisowicz

From: Ken Sanok, P.E.

Cc: Engineering Department, Technical Services,  
 StormTech Regional Product Managers

Date: 03/5/2010

**Subject: Design Guidance for the Isolator Row Weir**

**Isolator Row**

The Isolator Row is typically designed to treat the "first flush" and offers the versatility to be sized on a volume basis or flow rate basis. While the "first flush" will have the highest TSS, nutrient and hydrocarbon loading the unique design of the Isolator Row system continues to filter throughout the entire storm event. An upstream manhole/diversion structure not only provides access to the Isolator Row but typically includes a high flow weir such that the stormwater flow rates or volumes that exceed the capacity of the Isolator Row chambers overtop the weir and discharge through a manifold to the remainder of the chamber bed. There are several methods to divert the "first flush" into the Isolator Row (weirs, varying pipe inverts, etc.). This memo addresses the design of a weir for the Isolator Row diversion structure.

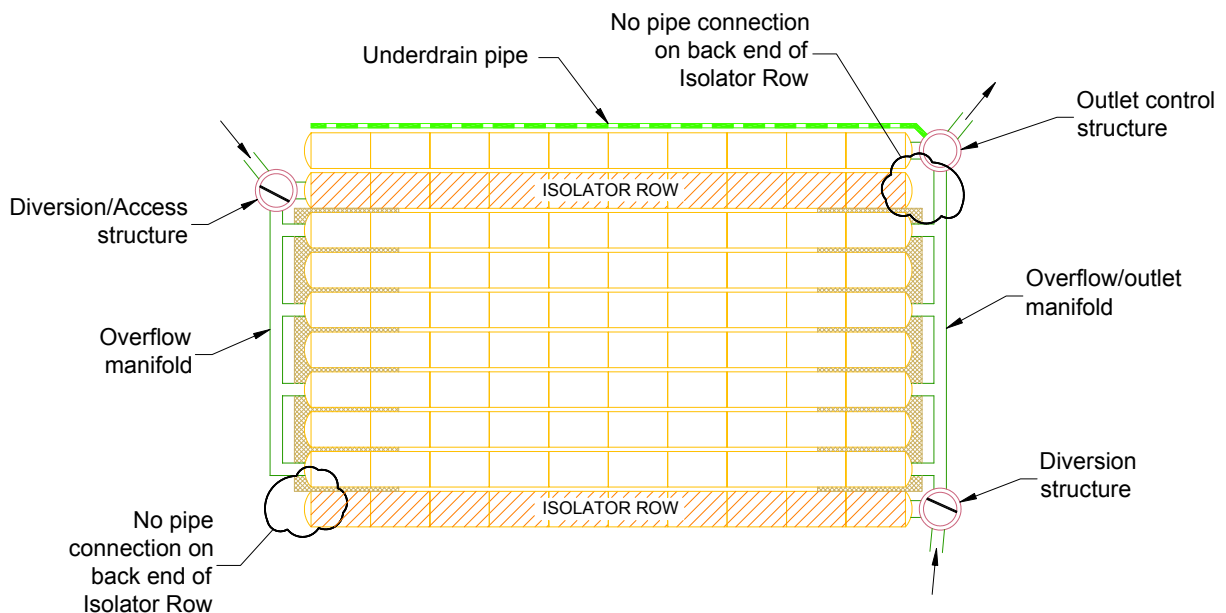

Figure 1 Typical StormTech Chamber Layout with Isolator Row

## Structure Placement

The diversion/access structure must be placed directly in front of the Isolator Row and must be connected by a 24" pipe to the SC-740, DC-780 and MC-3500 chambers and a 12" pipe to the SC-310 chamber. The structure will typically have a weir installed and a minimum size of 48 inches is recommended to allow access to the Isolator Row. The design engineer may select a smaller size structure for shallow systems with low flow rates. The actual size of the structure will vary based on the weir design, pipe sizes, pipe angles and design flow rate.

## Diversion Weir

The weir is situated to divert the runoff initially into the Isolator Row. The maximum weir crest elevation is determined by subtracting the head required to pass the peak flow from the maximum allowable water surface elevation. Typically the weir crest elevation ranges from the midpoint of the chamber up to the top of the chamber (see figure 2). The design of the weir is performed in several steps. The desired sized structure is drawn on the engineer's plans with the pipe connections. A weir is drawn in and the length is determined. The design engineer then determines the allowable water surface elevation over the weir crest in the structure (typically it is set at the same elevation as the top of the stone above the chambers). The weir crest elevation is then estimated. Start by assuming the elevation of the weir crest is at the same elevation as the top of the chambers. Thus the approach head (H) is the distance from the weir crest to the allowable water surface elevation.

The equation of a sharp crested weir can be written as follows <sup>[1]</sup>:

$$Q = C \sqrt{2g} LH^{3/2}$$

$$C = 0.40 + 0.05 \frac{H}{P}$$

Q = flow rate (cfs)

C = discharge coefficient

L = length of weir (ft)

H = approach head on the crest (ft)

P = height of crest above channel bottom (ft)

g = gravity (32.2 ft/s<sup>2</sup>)

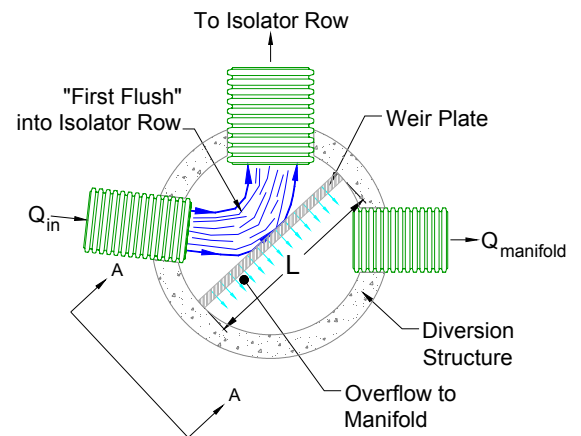

Figure 2A, Plan View of Diversion Structure

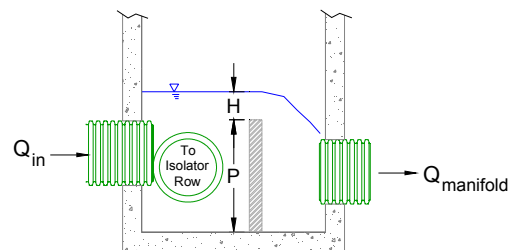

Figure 2B, Section A-A of Diversion Structure

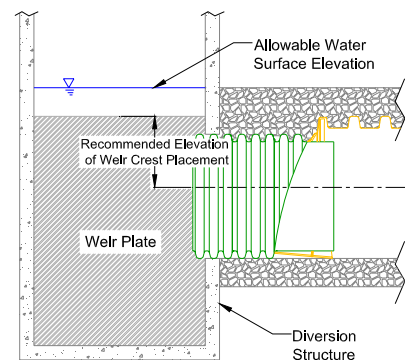

Figure 2C, Profile of Diversion Structure and Isolator Row

The flow over the weir can be calculated using these equations. This calculated flow is then compared to the design flow rate entering the structure. If this calculated flow is greater than the design flow rate then the weir is sufficient to pass the flows. If not, then the weir crest can be lowered and the calculations repeated. As mentioned previously StormTech recommends the weir crest be set between the top of the chamber and the midpoint of the chamber (see figure 2C). If the lowered crest cannot meet the design flow rate a larger structure can be analyzed which allows for a longer weir crest.

### **Other Considerations**

StormTech does not have any specifications for the material or structural design of the weir. It is the responsibility of the design engineer to ensure a material/design selected is adequate for the project design parameters. StormTech has found that aluminum weirs work well as the Isolator Row diversion weir.

Due to the confined nature of the structures it is possible that the weir will be suppressed and/or contracted. The design engineer must be aware of this and incorporate it into the design if deemed necessary.

- [1] Cassidy, J.J, Chaudhry, M.H., and Roberson, J.A., Hydraulic Engineering, 1<sup>st</sup> ed., Houghton Mifflin, Boston, 1988

Project: Harry Lee Cole School  
Location: Boxford, MA  
Client: Town of Boxford

Project Number: ENG20-0865  
Prepared By: AKG  
Date: April 7, 2021

---

---

**Standard 3: Recharge Calculations (Static Method)**

**Area 1 Infiltration Chambers (2P)**

Hydrologic Soils Group:	A	B	C	D	
Total Impervious Area (AC):	0.8313	0.3749	0.0000	0.0000	1.21
Target Factor:	0.60	0.35	0.25	0.10	
Required Recharge Volume:	1,811	476	0	0	2,287 CF

Volume Below Lowest Outlet: 3,956 CF  
Elevation of Lowest Invert: 94.20

**Determine Drawdown Time**

Saturated Hydraulic Conductivity (Rawls Rate): 2.41 IN/HR  
Bottom Area of Infiltration Basin: 3,602 SF  
Drawdown Time: 5.5 HRS

**Boxford MA - Harry Lee Cole School**  
**Water Quality Volume Calculation**  
*April 7, 2021*

Required Water Quality Storage  
 Proposed Paved Area      sf   x   1"      x   1 1/2" =      Required WQ Storage      CF

Location	Impervious Area (sqft)	Required WQ Storage (cf)	Provided WQ Storage (cf)	Description
Parking Lot A	39,093	3,258	3,956	Infiltration System (IS-1)

**Cole Post-Development**

Prepared by Weston & Sampson

HydroCAD® 10.10-5a s/n 00455 © 2020 HydroCAD Software Solutions LLC

Type III 24-hr 100-year Rainfall=8.30"

Printed 5/12/2021

**Stage-Area-Storage for Pond IS-1: IS-1 (continued)**

Elevation (feet)	Wetted (sq-ft)	Storage (cubic-feet)	Elevation (feet)	Wetted (sq-ft)	Storage (cubic-feet)
93.54	3,915	1,971	94.06	4,072	3,540
93.55	3,918	2,001	94.07	4,075	3,570
93.56	3,921	2,032	94.08	4,078	3,600
93.57	3,924	2,062	94.09	4,081	3,629
93.58	3,927	2,093	94.10	4,084	3,659
93.59	3,930	2,123	94.11	4,087	3,689
93.60	3,933	2,154	94.12	4,090	3,719
93.61	3,936	2,184	94.13	4,093	3,748
93.62	3,939	2,215	94.14	4,096	3,778
93.63	3,942	2,245	94.15	4,099	3,808
93.64	3,945	2,275	94.16	4,102	3,837
93.65	3,948	2,306	94.17	4,105	3,867
93.66	3,951	2,336	94.18	4,108	3,897
93.67	3,954	2,366	94.19	4,111	3,926
93.68	3,957	2,397	94.20	4,114	3,956
93.69	3,960	2,427	94.21	4,117	3,985
93.70	3,963	2,457	94.22	4,120	4,015
93.71	3,966	2,488	94.23	4,123	4,044
93.72	3,969	2,518	94.24	4,126	4,074
93.73	3,972	2,548	94.25	4,129	4,103
93.74	3,975	2,579	94.26	4,132	4,133
93.75	3,978	2,609	94.27	4,135	4,162
93.76	3,981	2,639	94.28	4,138	4,192
93.77	3,984	2,669	94.29	4,141	4,221
93.78	3,987	2,700	94.30	4,144	4,251
93.79	3,990	2,730	94.31	4,147	4,280
93.80	3,993	2,760	94.32	4,150	4,309
93.81	3,996	2,790	94.33	4,153	4,339
93.82	3,999	2,820	94.34	4,156	4,368
93.83	4,002	2,850	94.35	4,159	4,397
93.84	4,005	2,881	94.36	4,162	4,427
93.85	4,008	2,911	94.37	4,165	4,456
93.86	4,011	2,941	94.38	4,168	4,485
93.87	4,014	2,971	94.39	4,171	4,514
93.88	4,017	3,001	94.40	4,174	4,544
93.89	4,021	3,031	94.41	4,177	4,573
93.90	4,024	3,061	94.42	4,180	4,602
93.91	4,027	3,091	94.43	4,183	4,631
93.92	4,030	3,121	94.44	4,186	4,660
93.93	4,033	3,151	94.45	4,189	4,689
93.94	4,036	3,181	94.46	4,192	4,718
93.95	4,039	3,211	94.47	4,195	4,748
93.96	4,042	3,241	94.48	4,198	4,777
93.97	4,045	3,271	94.49	4,201	4,806
93.98	4,048	3,301	94.50	4,204	4,835
93.99	4,051	3,331	94.51	4,207	4,864
94.00	4,054	3,361	94.52	4,210	4,893
94.01	4,057	3,391	94.53	4,213	4,922
94.02	4,060	3,421	94.54	4,216	4,951
94.03	4,063	3,451	94.55	4,219	4,979
94.04	4,066	3,480	94.56	4,222	5,008
94.05	4,069	3,510	94.57	4,225	5,037

VOLUME BELOW  
LOWEST OUTLET

# Hydraflow Storm Sewers Extension for Autodesk® Civil 3D® Plan

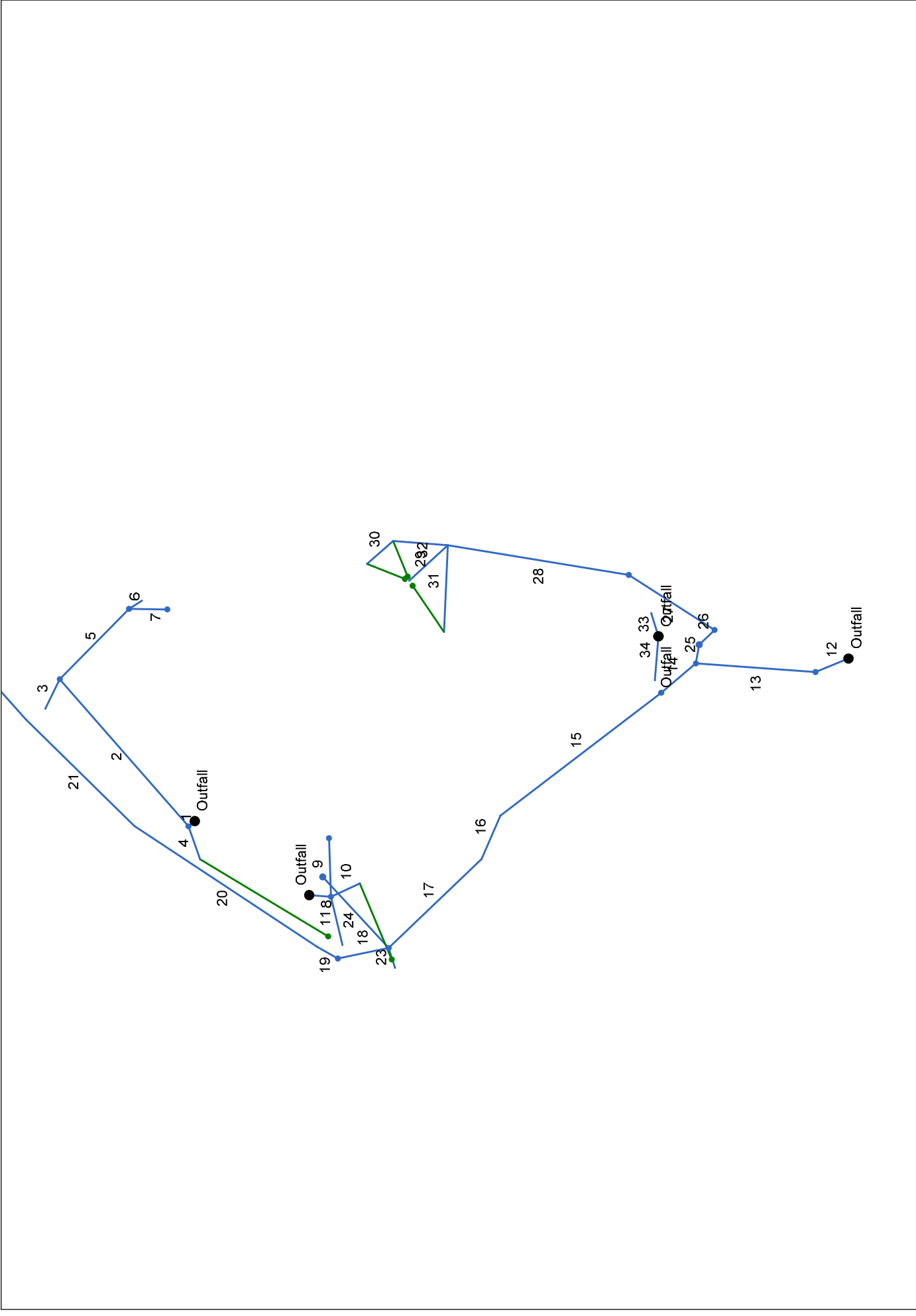

Project File: 11-5-21 Cole School.stm	Number of lines: 34	Date: 11/5/2021
---------------------------------------	---------------------	-----------------



# Structure Report

Struct No.	Structure ID	Junction Type	Rim Elev (ft)	Structure			Line Out			Line In		
				Shape	Length (ft)	Width (ft)	Size (in)	Shape	Invert (ft)	Size (in)	Shape	Invert (ft)
1	DMH-05	Manhole	100.64	Cir	4.00	4.00	18	Cir	94.04	12	Cir	94.14
2	DMH-04	Manhole	101.18	Cir	4.00	4.00	12	Cir	94.88	12	Cir	96.63
3	CB-02	Grate	101.20	Rect	0.00	4.00	12	Cir	98.00	12	Cir	97.84
4	CB-03	Grate	100.00	Rect	0.00	4.00	12	Cir	96.80	12	Cir	94.98
5	DMH-03	Manhole	99.94	Cir	4.00	4.00	12	Cir	95.35	12	Cir	96.43
6	CB-01	Grate	99.70	Rect	0.00	4.00	12	Cir	96.50	12	Cir	95.45
7	DMH-02	Manhole	100.35	Cir	4.00	4.00	12	Cir	95.59	12	Cir	95.37
8	DMH-06	Manhole	98.49	Cir	4.00	4.00	12	Cir	94.31	12	Cir	94.96
9	DMH-08	Manhole	99.34	Cir	4.00	4.00	12	Cir	96.22	12	Cir	94.41
10	CB-05	Grate	98.45	Rect	0.00	4.00	12	Cir	95.15	12	Cir	87.51
11	CB-04	Grate	97.85	Rect	0.00	4.00	12	Cir	94.65	12	Cir	88.38
12	EDMH-02	Manhole	93.00	Cir	4.00	4.00	24	Cir	87.41	24	Cir	88.16
13	EDMH-01	Manhole	94.15	Cir	4.00	4.00	24	Cir	88.06	24	Cir	88.97
14	DMH-11	Manhole	93.09	Cir	4.00	4.00	24	Cir	88.59	18	Cir	90.01
15	ECB-06	Grate	93.50	Rect	0.00	4.00	18	Cir	89.91	18	Cir	90.34
16	ECB-05	Grate	93.30	Rect	0.00	4.00	18	Cir	90.24	18	Cir	91.14
17	DMH-10	Manhole	97.32	Cir	4.00	4.00	18	Cir	90.94	18	Cir	93.10
18	DMH-09	Manhole	93.59	Cir	4.00	4.00	18	Cir	91.38	12	Cir	91.09
19	ECB-04	Grate	96.29	Rect	0.00	4.00	18	Cir	91.59	12	Cir	91.48
Project File: 11-5-21 Cole School.stm							Number of Structures: 34			Run Date: 11/5/2021		

# Structure Report

Struct No.	Structure ID	Junction Type	Rim Elev (ft)	Structure			Line Out			Line In		
				Shape	Length (ft)	Width (ft)	Size (in)	Shape	Invert (ft)	Size (in)	Shape	Invert (ft)
20	ECB-03	Grate	98.12	Rect	0.00	4.00	12	Cir	92.42	12	Cir	92.67
21	ECB-02	Grate	97.98	Rect	0.00	4.00	12	Cir	93.28	12	Cir	93.33
22	ECB-01	Grate	97.92	Rect	0.00	4.00	12	Cir	94.02			
23	CB-06	Grate	96.40	Rect	0.00	4.00	12	Cir	93.20			
24	OCS-1	Manhole	99.06	Cir	5.00	5.00	12	Cir	92.00			
25	OCS-3	Manhole	94.00	Cir	5.00	5.00	24	Cir	88.25	18	Cir	88.30
26	DMH-13	Manhole	93.54	Cir	4.00	4.00	18	Cir	88.40	18	Cir	88.45
27	DMH-12	Manhole	93.85	Cir	4.00	4.00	18	Cir	88.92	18	Cir	88.97
28	DMH-15	Manhole	94.49	Cir	0.00	0.00	18	Cir	89.80	12	Cir	90.40
29	CB-10	Grate	94.53	Rect	0.00	4.00	12	Cir	90.65	12	Cir	90.75
30	CB-09	Grate	95.13	Rect	0.00	4.00	12	Cir	90.92			
31	CB-12	Grate	95.04	Rect	0.00	4.00	12	Cir	90.82			
32	CB-11	Grate	94.75	Rect	0.00	4.00	12	Cir	90.15			
33	CB-08	Grate	92.75	Rect	0.00	4.00	12	Cir	89.55			
34	CB-07	Grate	92.80	Rect	0.00	4.00	12	Cir	89.60			

# Storm Sewer Summary Report

Line No.	Line ID	Flow rate (cfs)	Line Size (in)	Line shape	Line length (ft)	Invert EL Dn (ft)	Invert EL Up (ft)	Line Slope (%)	HGL Down (ft)	HGL Up (ft)	Minor loss (ft)	HGL Junct (ft)	Dns Line No.	Junction Type
1	P-09	2.59	18	Cir	7.748	94.00	94.04	0.516	95.43	94.65	n/a	94.65	End	Manhole
2	P-07	1.71	12	Cir	184.428	94.14	94.88	0.401	94.72	95.46	0.20	95.66	1	Manhole
3	P-05	0.59	12	Cir	31.542	97.84	98.00	0.507	98.12	98.30	n/a	98.30	2	Grate
4	P-08	0.88	12	Cir	33.660	96.63	96.80	0.505	96.98	97.17	n/a	97.17	1	Grate
5	P-04	1.12	12	Cir	92.888	94.98	95.35	0.398	95.61	95.77	n/a	95.89	2	Manhole
6	P-03	0.93	12	Cir	13.696	96.43	96.50	0.511	96.79	96.88	n/a	96.88	5	Grate
7	P-02	0.19	12	Cir	34.750	95.45	95.59	0.403	95.89	95.90	n/a	95.91	5	Manhole
8	P-10	3.40	12	Cir	19.688	94.01	94.31	1.524	95.43*	95.54*	n/a	95.78	End	Manhole
9	P-14	1.10	12	Cir	56.801	95.37	96.22	1.496	95.78	96.64	n/a	96.64	8	Manhole
10	P-12	0.81	12	Cir	29.148	94.96	95.15	0.652	95.78	95.51	n/a	95.51	8	Grate
11	P-11	1.49	12	Cir	47.970	94.41	94.65	0.500	95.78*	95.83*	n/a	95.87	8	Grate
12	P-29	23.58	24	Cir	32.661	87.25	87.41	0.490	88.71	88.87	n/a	88.87	End	Manhole
13	P-28	23.58	24	Cir	109.271	87.51	88.06	0.503	88.95	89.52	n/a	89.52	12	Manhole
14	P-27	3.86	24	Cir	42.386	88.38	88.59	0.495	89.52	89.24	n/a	89.24	13	Manhole
15	P-26	3.86	18	Cir	188.632	88.97	89.91	0.498	89.62	90.62	n/a	90.62	14	Grate
16	P-25	1.55	18	Cir	45.591	90.01	90.24	0.504	90.62	90.68	n/a	90.68	15	Grate
17	P-24	1.55	18	Cir	120.733	90.34	90.94	0.497	90.74	91.38	n/a	91.38	16	Manhole
18	P-18	0.94	18	Cir	47.432	91.14	91.38	0.506	91.45	91.71	n/a	91.71	17	Manhole
19	P-17	0.94	18	Cir	21.946	91.48	91.59	0.501	91.79	91.92	n/a	91.92	18	Grate
20	EP-03	0.67	12	Cir	203.304	91.69	92.42	0.359	92.07	92.81	n/a	92.84	19	Grate
21	EP-02	0.49	12	Cir	142.781	92.67	93.28	0.427	92.94	93.55	n/a	93.55	20	Grate
22	EP-01	0.18	12	Cir	87.875	93.33	94.02	0.785	93.55	94.18	n/a	94.18	21	Grate
23	P-16	0.19	12	Cir	20.203	93.10	93.20	0.495	93.25	93.35	n/a	93.35	17	Grate
24	P-15	0.42	12	Cir	91.344	91.09	92.00	0.996	91.38	92.27	n/a	92.27	17	Manhole

Project File: 11-5-21 Cole School.stm Run Date: 11/5/2021

Number of lines: 34

NOTES: Known Os only ; \*Surcharged (HGL above crown).

# Storm Sewer Summary Report

Line No.	Line ID	Flow rate (cfs)	Line Size (in)	Line shape	Line length (ft)	Invert EL Dn (ft)	Invert EL Up (ft)	Line Slope (%)	HGL Down (ft)	HGL Up (ft)	Minor loss (ft)	HGL Junct (ft)	Dns Line No.	Junction Type
25	P-23	19.72	24	Cir	18.473	88.16	88.25	0.487	89.52	89.54	n/a	89.54	13	Manhole
26	P-22	12.31	18	Cir	20.003	88.30	88.40	0.500	89.54	89.31	n/a	89.31	25	Manhole
27	P-21	6.24	18	Cir	94.515	88.45	88.92	0.497	89.32	89.83	n/a	89.83	26	Manhole
28	P-34	6.24	18	Cir	166.974	88.97	89.80	0.497	89.84	90.71	n/a	90.71	27	Manhole
29	P-31	3.12	12	Cir	49.932	90.40	90.65	0.501	91.17	91.41	n/a	91.76	28	Grate
30	P-30	1.56	12	Cir	32.616	90.75	90.92	0.521	91.76	91.78	n/a	91.84	29	Grate
31	P-32	1.56	12	Cir	84.057	90.40	90.82	0.500	90.88	91.32	n/a	91.32	28	Grate
32	P-33	1.56	12	Cir	49.082	89.91	90.15	0.489	90.71	90.65	n/a	90.65	28	Grate
33	P-20	1.53	12	Cir	23.200	89.44	89.55	0.474	90.21	90.05	n/a	90.05	End	Grate
34	P-19	0.83	12	Cir	42.708	89.39	89.60	0.492	90.21	89.94	n/a	89.94	End	Grate

Project File: 11-5-21 Cole School.stm Number of lines: 34 Run Date: 11/5/2021

NOTES: Known Os only ; \*Surcharged (HGL above crown).

# Storm Sewer Tabulation

Station	Line	To Line	Len (ft)	Drng Area		Rnoff coeff	Area x C		Tc		Rain (l)	Total flow (cfs)	Cap full (cfs)	Vel (ft/s)	Pipe		Invert Elev		HGL Elev		Grnd / Rim Elev		Line ID
				Incr (ac)	Total (ac)		Incr	Total	Inlet (min)	Syst (min)					Size (in)	Slope (%)	Dn (ft)	Up (ft)	Dn (ft)	Up (ft)	Dn (ft)	Up (ft)	
1	End		7.748	0.00	0.00	0.00	0.00	0.00	0.00	4.9	0.0	2.59	8.92	2.67	18	0.52	94.00	94.04	95.43	94.65	100.73	100.64	P-09
2	1	184.428	0.00	0.00	0.00	0.00	0.00	0.00	0.00	3.5	0.0	1.71	2.67	3.60	12	0.40	94.14	94.88	94.72	95.46	100.64	101.18	P-07
3	2	31.542	0.00	0.00	0.00	0.00	0.00	0.00	0.00	0.0	0.0	0.59	0.00	2.76	12	0.51	97.84	98.00	98.12	98.30	101.18	101.20	P-05
4	1	33.660	0.00	0.00	0.00	0.00	0.00	0.00	0.00	0.0	0.0	0.88	0.00	3.11	12	0.51	96.63	96.80	96.98	97.17	100.64	100.00	P-08
5	2	92.888	0.00	0.00	0.00	0.00	0.00	0.00	0.00	2.4	0.0	1.12	0.00	2.54	12	0.40	94.98	95.35	95.61	95.77	101.18	99.94	P-04
6	5	13.696	0.00	0.00	0.00	0.00	0.00	0.00	0.00	0.0	0.0	0.93	0.00	3.15	12	0.51	96.43	96.50	96.79	96.88	99.94	99.70	P-03
7	5	34.750	0.00	0.00	0.00	0.00	0.00	0.00	0.00	0.0	0.0	0.19	0.00	0.67	12	0.40	95.45	95.59	95.89	95.90	99.94	100.35	P-02
8	End	19.688	0.00	0.00	0.00	0.00	0.00	0.00	0.00	0.7	0.0	3.40	0.00	3.93	12	1.52	94.01	94.31	95.43	95.54	98.92	98.49	P-10
9	8	56.801	0.00	0.00	0.00	0.00	0.00	0.00	0.00	0.0	0.0	1.10	0.00	3.29	12	1.50	95.37	96.22	95.78	96.64	98.49	99.34	P-14
10	8	29.148	0.00	0.00	0.00	0.00	0.00	0.00	0.00	0.0	0.0	0.81	0.00	1.99	12	0.65	94.96	95.15	95.78	95.51	98.49	98.45	P-12
11	8	47.970	0.00	0.00	0.00	0.00	0.00	0.00	0.00	0.0	0.0	1.49	0.00	1.72	12	0.50	94.41	94.65	95.78	95.83	98.49	97.85	P-11
12	End	32.661	0.00	0.00	0.00	0.00	0.00	0.00	0.00	21.8	0.0	23.58	0.00	6.68	24	0.49	87.25	87.41	88.71	88.87	93.66	93.00	P-29
13	12	109.271	0.00	0.00	0.00	0.00	0.00	0.00	0.00	21.5	0.0	23.58	0.00	6.74	24	0.50	87.51	88.06	88.95	89.52	93.00	94.15	P-28
14	13	42.386	0.00	0.00	0.00	0.00	0.00	0.00	0.00	21.0	0.0	3.86	0.00	2.88	24	0.50	88.38	88.59	89.52	89.24	94.15	93.09	P-27
15	14	188.632	0.00	0.00	0.00	0.00	0.00	0.00	0.00	19.5	0.0	3.86	0.00	4.43	18	0.50	88.97	89.91	89.62	90.62	93.09	93.50	P-26
16	15	45.591	0.00	0.00	0.00	0.00	0.00	0.00	0.00	18.6	0.0	1.55	0.00	2.63	18	0.50	90.01	90.24	90.62	90.68	93.50	93.30	P-25
17	16	120.733	0.00	0.00	0.00	0.00	0.00	0.00	0.00	16.4	0.0	1.55	0.00	3.40	18	0.50	90.34	90.94	90.74	91.38	93.30	97.32	P-24
18	17	47.432	0.00	0.00	0.00	0.00	0.00	0.00	0.00	14.9	0.0	0.94	0.00	2.94	18	0.51	91.14	91.38	91.45	91.71	97.32	93.59	P-18
19	18	21.946	0.00	0.00	0.00	0.00	0.00	0.00	0.00	14.2	0.0	0.94	0.00	2.93	18	0.50	91.48	91.59	91.79	91.92	93.59	96.29	P-17
20	19	203.304	0.00	0.00	0.00	0.00	0.00	0.00	0.00	10.2	0.0	0.67	0.00	2.08	12	0.36	91.69	92.42	92.07	92.81	96.29	98.12	EP-03
21	20	142.781	0.00	0.00	0.00	0.00	0.00	0.00	0.00	6.4	0.0	0.49	0.00	2.52	12	0.43	92.67	93.28	92.94	93.55	98.12	97.98	EP-02
22	21	87.875	0.00	0.00	0.00	0.00	0.00	0.00	0.00	0.0	0.0	0.18	0.00	1.52	12	0.79	93.33	94.02	93.55	94.18	97.98	97.92	EP-01

Project File: 11-5-21 Cole School.stm

Number of lines: 34

Run Date: 11/5/2021

NOTES: Known Qs only ; c = cir e = ellip b = box

# Storm Sewer Tabulation

Station	Line	To Line	Len (ft)	Drng Area		Rnoff coeff (C)	Area x C		Tc		Rain (l) (in/hr)	Total flow (cfs)	Cap full (cfs)	Vel (ft/s)	Pipe		Invert Elev		HGL Elev		Grnd / Rim Elev		Line ID
				Incr (ac)	Total (ac)		Incr	Total	Inlet (min)	Syst (min)					Size (in)	Slope (%)	Dn (ft)	Up (ft)	Dn (ft)	Up (ft)	Dn (ft)	Up (ft)	
23	17		20.203	0.00	0.00	0.00	0.00	0.00	0.0	0.0	0.19	0.00	1.89	12	0.49	93.10	93.20	93.25	93.35	97.32	96.40	P-16	
24	17		91.344	0.00	0.00	0.00	0.00	0.0	0.0	0.0	0.42	0.00	2.36	12	1.00	91.09	92.00	91.38	92.27	97.32	99.06	P-15	
25	13		18.473	0.00	0.00	0.00	0.00	0.0	2.0	0.0	19.72	0.00	5.87	24	0.49	88.16	88.25	89.52	89.54	94.15	94.00	P-23	
26	25		20.003	0.00	0.00	0.00	0.00	0.0	1.9	0.0	12.31	0.00	4.26	18	0.50	88.30	88.40	89.54	89.31	94.00	93.54	P-22	
27	26		94.515	0.00	0.00	0.00	0.00	0.0	1.5	0.0	6.24	0.00	5.11	18	0.50	88.45	88.92	89.32	89.83	93.54	93.85	P-21	
28	27		166.974	0.00	0.00	0.00	0.00	0.0	0.7	0.0	6.24	0.00	5.10	18	0.50	88.97	89.80	89.84	90.71	93.85	94.49	P-34	
29	28		49.932	0.00	0.00	0.00	0.00	0.0	0.3	0.0	3.12	0.00	4.31	12	0.50	90.40	90.65	91.17	91.41	94.49	94.53	P-31	
30	29		32.616	0.00	0.00	0.00	0.00	0.0	0.0	0.0	1.56	0.00	1.85	12	0.52	90.75	90.92	91.76	91.78	94.53	95.13	P-30	
31	28		84.057	0.00	0.00	0.00	0.00	0.0	0.0	0.0	1.56	0.00	3.64	12	0.50	90.40	90.82	90.88	91.32	94.49	95.04	P-32	
32	28		49.082	0.00	0.00	0.00	0.00	0.0	0.0	0.0	1.56	0.00	2.81	12	0.49	89.91	90.15	90.71	90.65	94.49	94.75	P-33	
33	End		23.200	0.00	0.00	0.00	0.00	0.0	0.0	0.0	1.53	0.00	2.86	12	0.47	89.44	89.55	90.21	90.05	93.16	92.75	P-20	
34	End		42.708	0.00	0.00	0.00	0.00	0.0	0.0	0.0	0.83	0.00	1.92	12	0.49	89.39	89.60	90.21	89.94	93.16	92.80	P-19	

Project File: 11-5-21 Cole School.stm

Number of lines: 34

Run Date: 11/5/2021

NOTES: Known Qs only ; c = cir e = ellip b = box

# Inlet Report

Line No	Inlet ID	Q = CIA (cfs)	Q carry (cfs)	Q capt (cfs)	Q Byp (cfs)	Junc Type	Curb Inlet		Grate Inlet			Gutter						Inlet			Bye Line No					
							Ht (in)	L (ft)	Area (sqft)	L (ft)	W (ft)	So (ft/ft)	W (ft)	Sw (ft/ft)	Sx (ft/ft)	n	Depth (ft)	Spread (ft)	Depth (ft)	Spread (ft)		Depth (ft)	Spread (ft)	Depr (in)		
1	DMH-05	0.00	0.00	0.00	0.00	MH	0.0	0.00	0.00	0.00	Sag	0.00	0.000	0.000	0.000	0.00	0.00	0.00	0.00	0.00	0.00	0.00	0.00	0.00	0.0	Off
2	DMH-04	0.00	0.00	0.00	0.00	MH	0.0	0.00	0.00	0.00	Sag	0.00	0.000	0.000	0.000	0.00	0.00	0.00	0.00	0.00	0.00	0.00	0.00	0.00	0.0	Off
3	CB-02	0.59*	0.00	0.59	0.00	Grate	0.0	0.00	4.00	2.00	Sag	2.00	0.020	0.020	0.013	-0.05	1.41	0.20	1.41	0.20	1.41	0.20	1.41	3.0	Off	
4	CB-03	0.88*	0.00	0.64	0.24	Grate	0.0	0.00	0.00	2.00	0.023	2.00	0.020	0.020	0.013	0.11	5.44	0.07	3.33	0.07	3.33	0.07	3.33	0.0	11	
5	DMH-03	0.00	0.00	0.00	0.00	MH	0.0	0.00	0.00	0.00	Sag	0.00	0.000	0.000	0.000	0.00	0.00	0.00	0.00	0.00	0.00	0.00	0.00	0.0	Off	
6	CB-01	0.93*	0.00	0.93	0.00	Grate	0.0	0.00	4.00	2.00	Sag	2.00	0.020	0.020	0.013	0.03	1.91	0.28	1.91	0.28	1.91	0.28	1.91	3.0	Off	
7	DMH-02	0.19*	0.00	0.00	0.19	MH	0.0	0.00	0.00	0.00	Sag	0.00	0.000	0.000	0.013	0.00	0.00	0.00	0.00	0.00	0.00	0.00	0.00	0.0	Off	
8	DMH-06	0.00	0.00	0.00	0.00	MH	0.0	0.00	0.00	0.00	Sag	0.00	0.000	0.000	0.000	0.00	0.00	0.00	0.00	0.00	0.00	0.00	0.00	0.0	Off	
9	DMH-08	1.10*	0.00	0.00	1.10	MH	0.0	0.00	0.00	0.00	Sag	0.00	0.000	0.000	0.013	0.00	0.00	0.00	0.00	0.00	0.00	0.00	0.00	0.0	Off	
10	CB-05	0.81*	0.00	0.62	0.19	Grate	0.0	0.00	0.00	2.00	0.030	2.00	0.020	0.020	0.013	0.10	5.02	0.06	2.93	0.06	2.93	0.06	2.93	0.0	23	
11	CB-04	1.49*	0.24	1.73	0.00	Grate	0.0	0.00	4.00	2.00	Sag	2.00	0.020	0.020	0.013	0.10	5.22	0.35	5.22	0.35	5.22	0.35	5.22	3.0	Off	
12	EDMH-02	0.00	0.00	0.00	0.00	MH	0.0	0.00	0.00	0.00	Sag	0.00	0.000	0.000	0.000	0.00	0.00	0.00	0.00	0.00	0.00	0.00	0.00	0.0	Off	
13	EDMH-01	0.00	0.00	0.00	0.00	MH	0.0	0.00	0.00	0.00	Sag	0.00	0.000	0.000	0.000	0.00	0.00	0.00	0.00	0.00	0.00	0.00	0.00	0.0	Off	
14	DMH-11	0.00	0.00	0.00	0.00	MH	0.0	0.00	0.00	0.00	Sag	0.00	0.000	0.000	0.000	0.00	0.00	0.00	0.00	0.00	0.00	0.00	0.00	0.0	Off	
15	ECB-06	2.31*	-nan(ind)	-nan(ind)	-nan(ind)	Grate	0.0	0.00	4.00	2.00	Sag	2.00	0.020	0.020	0.013	-nan(ind)	-nan(ind)	-nan(ind)	-nan(ind)	-nan(ind)	-nan(ind)	-nan(ind)	-nan(ind)	0.00	Off	
16	ECB-05	0.00	0.00	0.00	-nan(ind)	Grate	0.0	0.00	0.00	2.00	0.015	2.00	0.020	0.020	0.013	0.00	0.00	5.00	250.00	5.00	250.00	5.00	250.00	0.0	15	
17	DMH-10	0.00	0.00	0.00	0.00	MH	0.0	0.00	0.00	0.00	Sag	0.00	0.000	0.000	0.000	0.00	0.00	0.00	0.00	0.00	0.00	0.00	0.00	0.0	Off	
18	DMH-09	0.00	0.00	0.00	0.00	MH	0.0	0.00	0.00	0.00	Sag	0.00	0.000	0.000	0.000	0.00	0.00	0.00	0.00	0.00	0.00	0.00	0.00	0.0	Off	
19	ECB-04	0.27*	0.02	0.25	0.03	Grate	0.0	0.00	0.00	2.00	0.015	2.00	0.020	0.020	0.013	0.08	3.88	0.04	1.76	0.04	1.76	0.04	1.76	0.0	Off	
20	ECB-03	0.18*	0.04	0.20	0.02	Grate	0.0	0.00	0.00	2.00	0.015	2.00	0.020	0.020	0.013	0.07	3.53	0.03	1.39	0.03	1.39	0.03	1.39	0.0	19	
21	ECB-02	0.31*	0.01	0.28	0.04	Grate	0.0	0.00	0.00	2.00	0.015	2.00	0.020	0.020	0.013	0.08	4.04	0.04	1.90	0.04	1.90	0.04	1.90	0.0	20	
22	ECB-01	0.18*	0.00	0.17	0.01	Grate	0.0	0.00	0.00	2.00	0.015	2.00	0.020	0.020	0.013	0.07	3.25	0.02	1.14	0.02	1.14	0.02	1.14	0.0	21	
23	CB-06	0.19*	0.19	0.35	0.03	Grate	0.0	0.00	0.00	2.00	0.055	2.00	0.020	0.020	0.013	0.07	3.38	0.03	1.34	0.03	1.34	0.03	1.34	0.0	Off	

Project File: 11-5-21 Cole School.stm

Number of lines: 34

Run Date: 11/5/2021

NOTES: Inlet N-Values = 0.016; Known Qs only; \* Indicates Known Q added. All curb inlets are throat.

# Inlet Report

Line No	Inlet ID	Q = CIA (cfs)	Q carry (cfs)	Q capt (cfs)	Q Byp (cfs)	Junc Type	Curb Inlet		Grate Inlet			Gutter						Inlet			Byp Line No								
							Ht (in)	L (ft)	Area (sqft)	L (ft)	W (ft)	So (ft/ft)	W (ft)	Sw (ft/ft)	Sx (ft/ft)	n	Depth (ft)	Spread (ft)	Depth (ft)	Spread (ft)		Depth (ft)	Spread (ft)						
24	OCS-1	0.42*	0.00	0.00	0.42	MH	0.0	0.00	0.00	0.00	Sag	0.00	0.000	0.000	0.000	0.00	0.00	0.00	0.00	0.00	0.00	0.00	0.00	0.00	0.00	0.00	0.00	0.00	Off
25	OCS-3	7.41*	0.00	0.00	7.41	MH	0.0	0.00	0.00	0.00	Sag	0.00	0.000	0.000	0.000	0.00	0.00	0.00	0.00	0.00	0.00	0.00	0.00	0.00	0.00	0.00	0.00	0.00	Off
26	DMH-13	6.07*	0.00	0.00	6.07	MH	0.0	0.00	0.00	0.00	Sag	0.00	0.000	0.000	0.013	0.00	0.00	0.00	0.00	0.00	0.00	0.00	0.00	0.00	0.00	0.00	0.00	0.00	Off
27	DMH-12	0.00	0.00	0.00	0.00	MH	0.0	0.00	0.00	0.00	Sag	0.00	0.000	0.000	0.000	0.00	0.00	0.00	0.00	0.00	0.00	0.00	0.00	0.00	0.00	0.00	0.00	0.00	Off
28	DMH-15	0.00	0.00	0.00	0.00	MH	0.0	0.00	0.00	0.00	Sag	0.00	0.000	0.000	0.000	0.00	0.00	0.00	0.00	0.00	0.00	0.00	0.00	0.00	0.00	0.00	0.00	0.00	Off
29	CB-10	1.56*	0.00	0.95	0.61	Grate	0.0	0.00	0.00	2.00	0.015	2.00	0.020	0.020	0.013	0.15	7.31	0.10	5.13	0.10	5.13	0.10	5.13	0.10	5.13	0.10	5.13	0.00	32
30	CB-09	1.56*	0.00	0.95	0.61	Grate	0.0	0.00	0.00	2.00	0.015	2.00	0.020	0.020	0.013	0.15	7.31	0.10	5.13	0.10	5.13	0.10	5.13	0.10	5.13	0.10	5.13	0.00	32
31	CB-12	1.56*	0.00	0.95	0.61	Grate	0.0	0.00	0.00	2.00	0.015	2.00	0.020	0.020	0.013	0.15	7.31	0.10	5.13	0.10	5.13	0.10	5.13	0.10	5.13	0.10	5.13	0.00	32
32	CB-11	1.56*	1.82	3.38	0.00	Grate	0.0	0.00	8.00	4.00	Sag	2.00	0.020	0.020	0.013	0.17	8.27	0.42	8.27	0.42	8.27	0.42	8.27	0.42	8.27	3.0	3.0	Off	
33	CB-08	1.53*	0.00	1.53	0.00	Grate	0.0	0.00	4.00	2.00	Sag	2.00	0.020	0.020	0.013	0.09	4.41	0.34	4.41	0.34	4.41	0.34	4.41	0.34	4.41	3.0	3.0	Off	
34	CB-07	0.83*	0.00	0.83	0.00	Grate	0.0	0.00	4.00	2.00	Sag	2.00	0.020	0.020	0.013	0.01	1.77	0.26	1.77	0.26	1.77	0.26	1.77	0.26	1.77	3.0	3.0	Off	

Project File: 11-5-21 Cole School.stm

Number of lines: 34

Run Date: 11/5/2021

NOTES: Inlet N-Values = 0.016; Known Qs only; \* Indicates Known Q added. All curb inlets are throat.



# Hydraulic Grade Line Computations

Line Size (in)	Q (cfs)	Downstream						Len (ft)	Upstream						Check		JL coeff (K)	Minor loss (ft)					
		Invert elev (ft)	HGL elev (ft)	Depth (ft)	Area (sqft)	Vel (ft/s)	Vel head (ft)		EGL elev (ft)	Sf (%)	Invert elev (ft)	HGL elev (ft)	Depth (ft)	Area (sqft)	Vel (ft/s)	Vel head (ft)			EGL elev (ft)	Sf (%)	Ave Sf (%)	Energy loss (ft)	
1	18	2.59	94.00	95.43	1.43	0.67	1.49	0.23	95.66	0.000	7.748	94.04	94.65	0.61**	0.67	3.84	0.23	94.88	0.000	0.000	n/a	1.00	n/a
2	12	1.71	94.14	94.72	0.58*	0.47	3.60	0.20	94.92	0.401	184.42	894.88	95.46	0.58	0.48	3.60	0.20	95.66	0.401	0.739	1.00	0.20	0.20
3	12	0.59	97.84	98.12	0.00	0.00	2.87	0.00	98.12	0.000	31.542	98.00	98.30	0.00**	0.00	2.65	0.00	98.30	0.000	0.000	0.000	1.00	n/a
4	12	0.88	96.63	96.98	0.00	0.00	3.22	0.00	96.98	0.000	33.660	96.80	97.17	0.00**	0.00	2.99	0.00	97.17	0.000	0.000	0.000	1.00	n/a
5	12	1.12	94.98	95.61	0.00	0.00	1.90	0.00	95.61	0.000	92.888	95.35	95.77	0.00**	0.00	3.17	0.00	95.77	0.000	0.000	0.000	0.78	n/a
6	12	0.93	96.43	96.79	0.00	0.00	3.27	0.00	96.79	0.000	13.696	96.50	96.88	0.00**	0.00	3.02	0.00	96.88	0.000	0.000	0.000	1.00	n/a
7	12	0.19	95.45	95.89	0.00	0.00	0.50	0.00	95.89	0.000	34.750	95.59	95.90	0.00**	0.00	0.84	0.00	95.90	0.000	0.000	0.000	1.00	n/a
8	12	3.40	94.01	95.43	0.00	0.00	3.94	0.00	95.43	0.000	19.688	94.31	95.54	0.00**	0.00	3.93	0.00	95.54	0.000	0.000	0.000	1.00	n/a
9	12	1.10	95.37	95.78	0.00	0.00	3.37	0.00	95.78	0.000	56.801	96.22	96.64	0.00**	0.00	3.21	0.00	96.64	0.000	0.000	0.000	1.00	n/a
10	12	0.81	94.96	95.78	0.00	0.00	1.06	0.00	95.78	0.000	29.148	95.15	95.51	0.00**	0.00	2.91	0.00	95.51	0.000	0.000	0.000	1.00	n/a
11	12	1.49	94.41	95.78	0.00	0.00	1.72	0.00	95.78	0.000	47.970	94.65	95.83	0.00**	0.00	1.72	0.00	95.83	0.000	0.000	0.000	1.00	n/a
12	24	23.58	87.25	88.71	0.00	0.00	6.68	0.00	88.71	0.000	32.661	87.41	88.87	0.00**	0.00	6.68	0.00	88.87	0.000	0.000	0.000	0.52	n/a
13	24	23.58	87.51	88.95	0.00	0.00	6.79	0.00	88.95	0.000	109.27	88.06	89.52	0.00**	0.00	6.68	0.00	89.52	0.000	0.000	0.000	1.00	n/a
14	24	3.86	88.38	89.52	0.00	0.00	1.86	0.00	89.52	0.000	42.386	88.59	89.24	0.00**	0.00	3.90	0.00	89.24	0.000	0.000	0.000	0.15	n/a
15	18	3.86	88.97	89.62	0.00	0.00	4.66	0.00	89.62	0.000	188.63	89.91	90.62	0.00**	0.00	4.20	0.00	90.62	0.000	0.000	0.000	0.81	n/a
16	18	1.55	90.01	90.62	0.00	0.00	2.06	0.00	90.62	0.000	45.591	90.24	90.68	0.00**	0.00	3.19	0.00	90.68	0.000	0.000	0.000	0.66	n/a
17	18	1.55	90.34	90.74	0.00	0.00	3.60	0.00	90.74	0.000	120.73	89.94	91.38	0.00**	0.00	3.19	0.00	91.38	0.000	0.000	0.000	1.00	n/a
18	18	0.94	91.14	91.45	0.00	0.00	3.11	0.00	91.45	0.000	47.432	91.38	91.71	0.00**	0.00	2.76	0.00	91.71	0.000	0.000	0.000	0.73	n/a
19	18	0.94	91.48	91.79	0.00	0.00	3.10	0.00	91.79	0.000	21.946	91.59	91.92	0.00**	0.00	2.76	0.00	91.92	0.000	0.000	0.000	0.50	n/a
20	12	0.67	91.69	92.07	0.00	0.00	2.08	0.00	92.07	0.000	203.30	92.42	92.81	0.00**	0.00	2.08	0.00	92.81	0.000	0.000	0.000	0.50	n/a
21	12	0.49	92.67	92.94	0.00	0.00	2.55	0.00	92.94	0.000	142.78	93.28	93.55	0.00**	0.00	2.50	0.00	93.55	0.000	0.000	0.000	0.50	n/a
22	12	0.18	93.33	93.55	0.00	0.00	1.16	0.00	93.55	0.000	87.875	94.02	94.18	0.00**	0.00	1.88	0.00	94.18	0.000	0.000	0.000	1.00	n/a

Project File: 11-5-21 Cole School.stm

Number of lines: 34

Run Date: 11/5/2021

Notes: \* depth assumed, \*\* Critical depth. ; c = cir e = ellip b = box

# Hydraulic Grade Line Computations

Line Size (in)	Q (cfs)	Downstream						Len (ft)	Upstream						Check		JL coeff (K)	Minor loss (ft)		
		Invert elev (ft)	HGL elev (ft)	Depth (ft)	Area (sqft)	Vel (ft/s)	Vel head (ft)		EGL elev (ft)	Sf (%)	Invert elev (ft)	HGL elev (ft)	Depth (ft)	Area (sqft)	Vel (ft/s)	Vel head (ft)			EGL elev (ft)	Sf (%)
23	0.19	93.10	93.25	0.00	0.00	1.93	0.00	20.203	93.20	93.35	0.00**	0.00	1.84	0.00	93.35	0.000	0.000	0.000	1.00	n/a
24	0.42	91.09	91.38	0.00	0.00	2.24	0.00	91.344	92.00	92.27	0.00**	0.00	2.48	0.00	92.27	0.000	0.000	0.000	1.00	n/a
25	19.72	88.16	89.52	0.00	0.00	5.70	0.00	18.473	88.25	89.54	0.00**	0.00	6.03	0.00	89.54	0.000	0.000	0.000	0.63	n/a
26	12.31	88.30	89.54	0.00	0.00	3.55	0.00	20.003	88.40	89.31	0.00**	0.00	4.97	0.00	89.31	0.000	0.000	0.000	1.00	n/a
27	6.24	88.45	89.32	0.00	0.00	5.25	0.00	94.515	88.92	89.83	0.00**	0.00	4.97	0.00	89.83	0.000	0.000	0.000	0.47	n/a
28	6.24	88.97	89.84	0.00	0.00	5.24	0.00	166.97	89.80	90.71	0.00**	0.00	4.97	0.00	90.71	0.000	0.000	0.000	1.00	n/a
29	3.12	90.40	91.17	0.00	0.00	4.31	0.00	49.932	90.65	91.41	0.00**	0.00	4.31	0.00	91.41	0.000	0.000	0.000	1.18	n/a
30	1.56	90.75	91.76	0.00	0.00	1.77	0.00	32.616	90.92	91.78	0.00**	0.00	1.93	0.00	91.78	0.000	0.000	0.000	1.00	n/a
31	1.56	90.40	90.88	0.00	0.00	3.72	0.00	84.057	90.82	91.32	0.00**	0.00	3.55	0.00	91.32	0.000	0.000	0.000	1.00	n/a
32	1.56	89.91	90.71	0.00	0.00	2.07	0.00	49.082	90.15	90.65	0.00**	0.00	3.55	0.00	90.65	0.000	0.000	0.000	1.00	n/a
33	1.53	89.44	90.21	0.00	0.00	2.16	0.00	23.200	89.55	90.05	0.00**	0.00	3.56	0.00	90.05	0.000	0.000	0.000	1.00	n/a
34	0.83	89.39	90.21	0.00	0.00	0.99	0.00	42.708	89.60	89.94	0.00**	0.00	2.85	0.00	89.94	0.000	0.000	0.000	1.00	n/a

Project File: 11-5-21 Cole School.stm Number of lines: 34 Run Date: 11/5/2021

Notes: \* depth assumed, \*\* Critical depth. ; c = cir e = ellip b = box

# Storm Sewer Profile

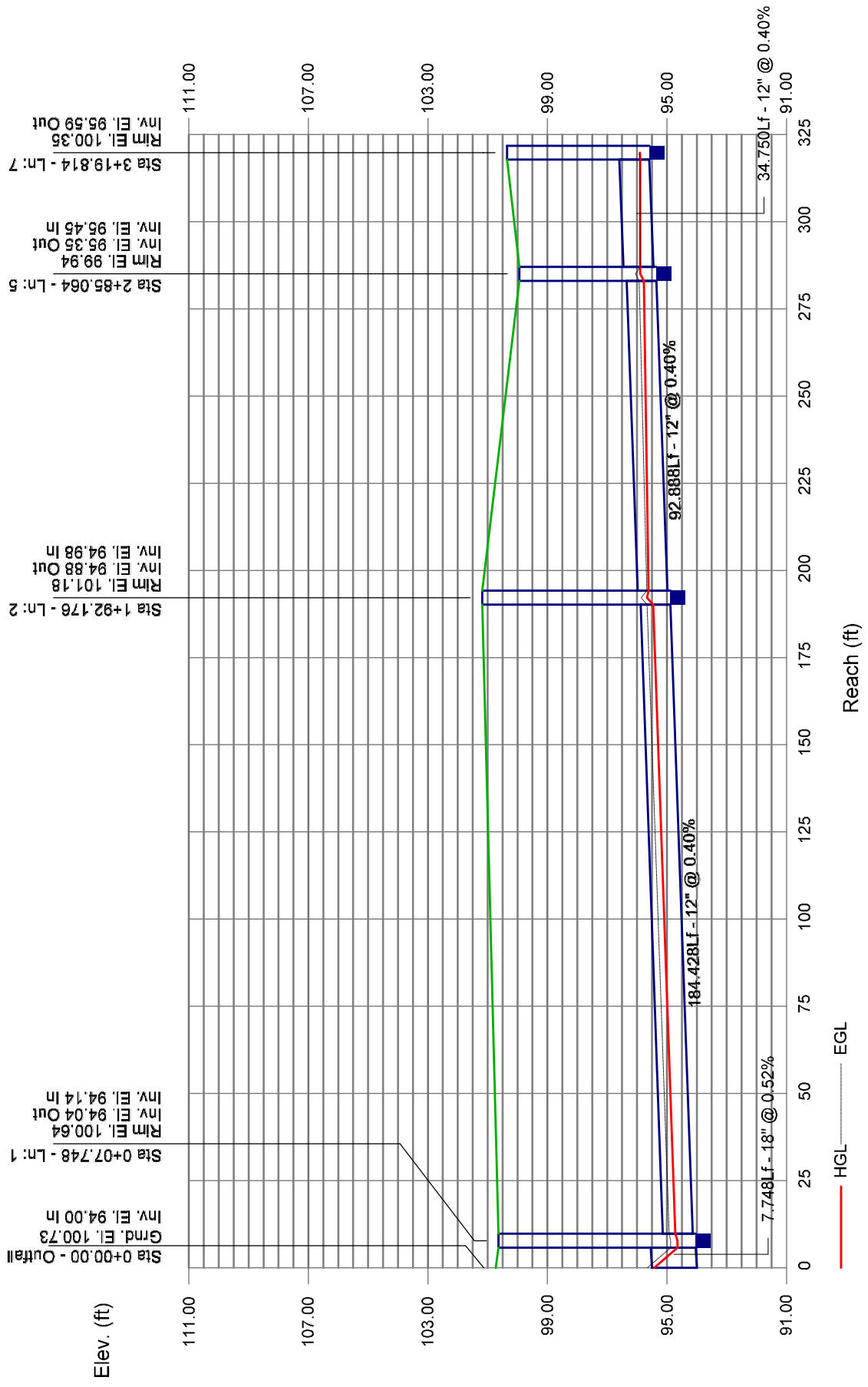

# Storm Sewer Profile

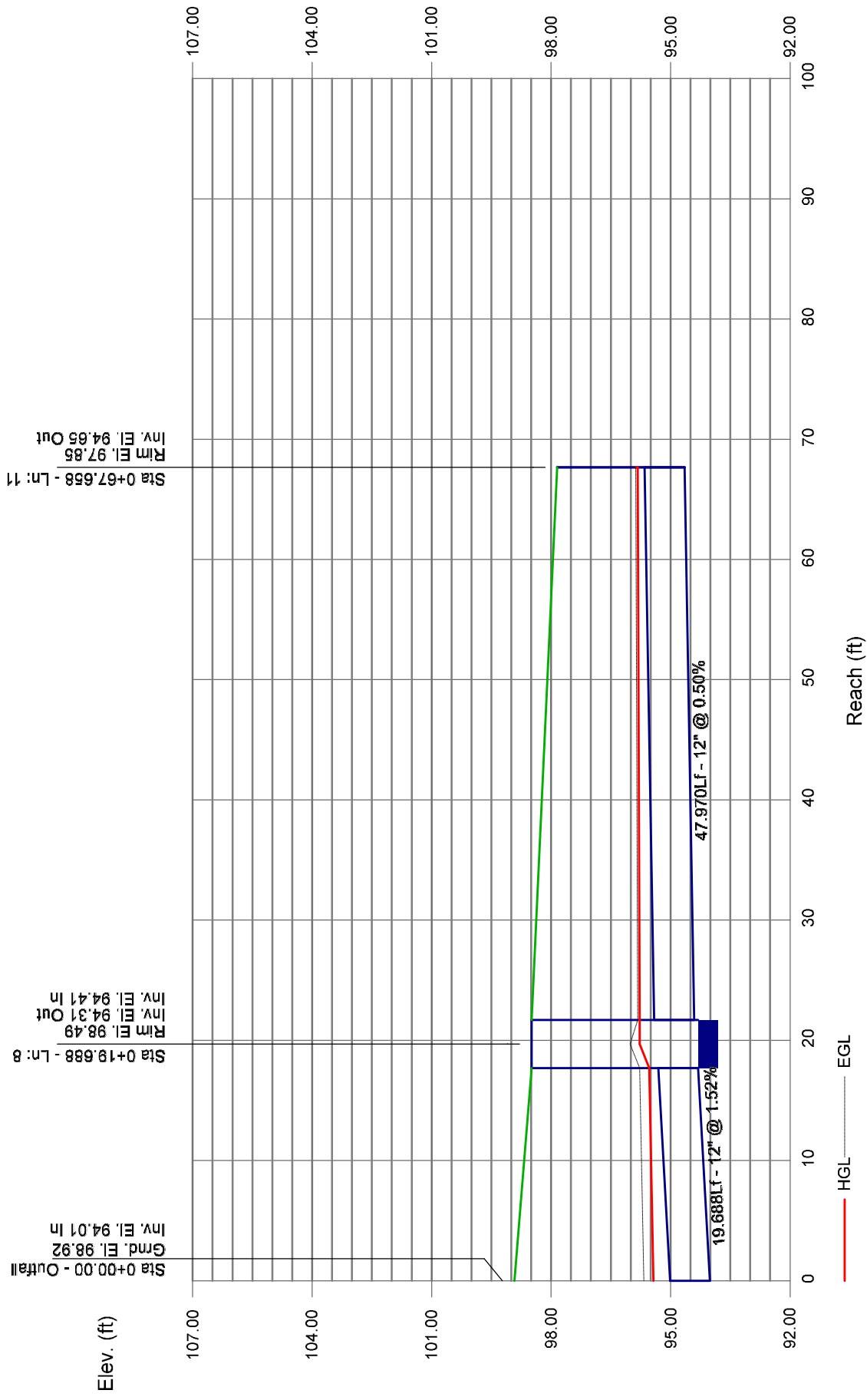

# Storm Sewer Profile

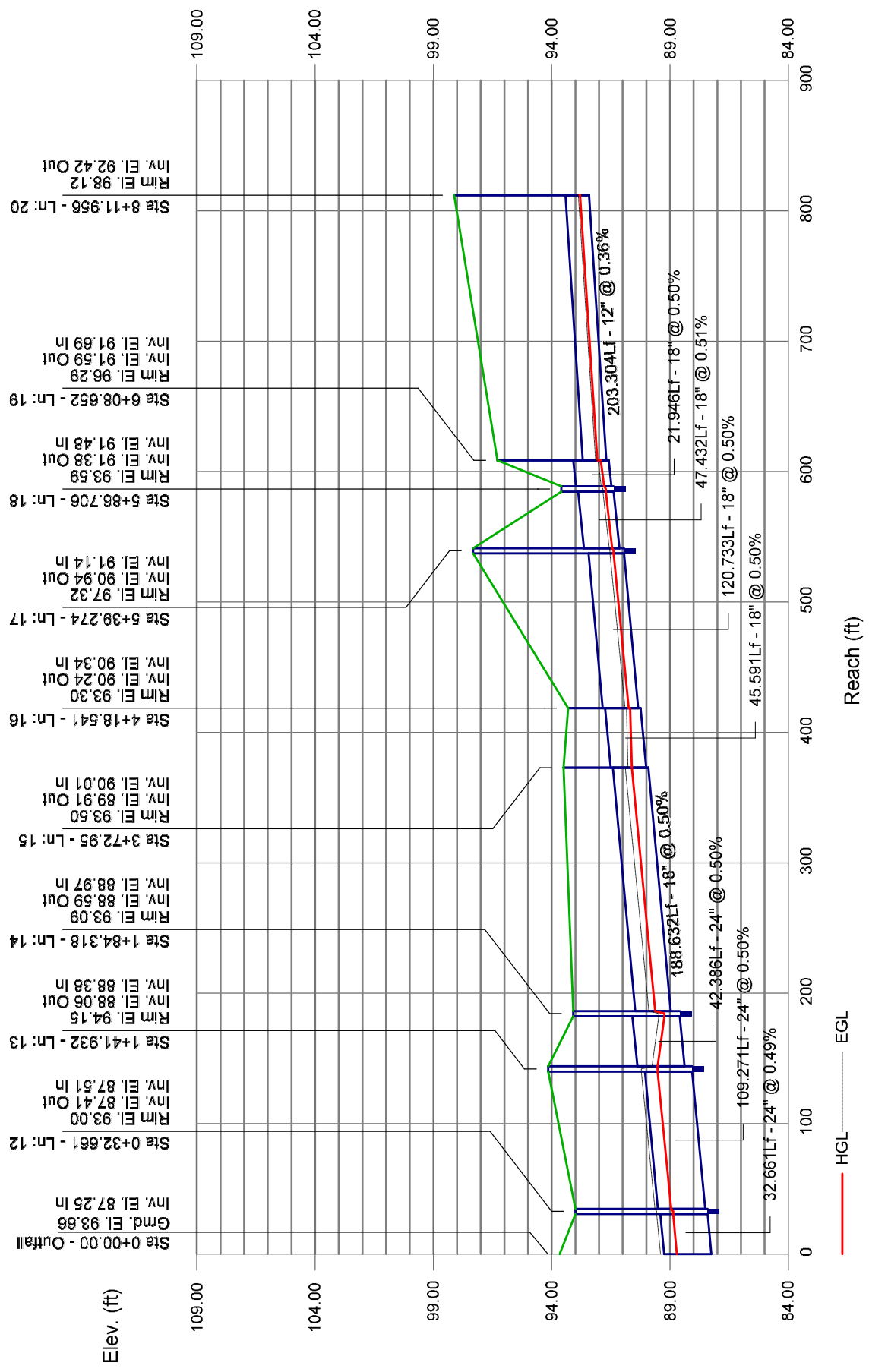

# Storm Sewer Profile

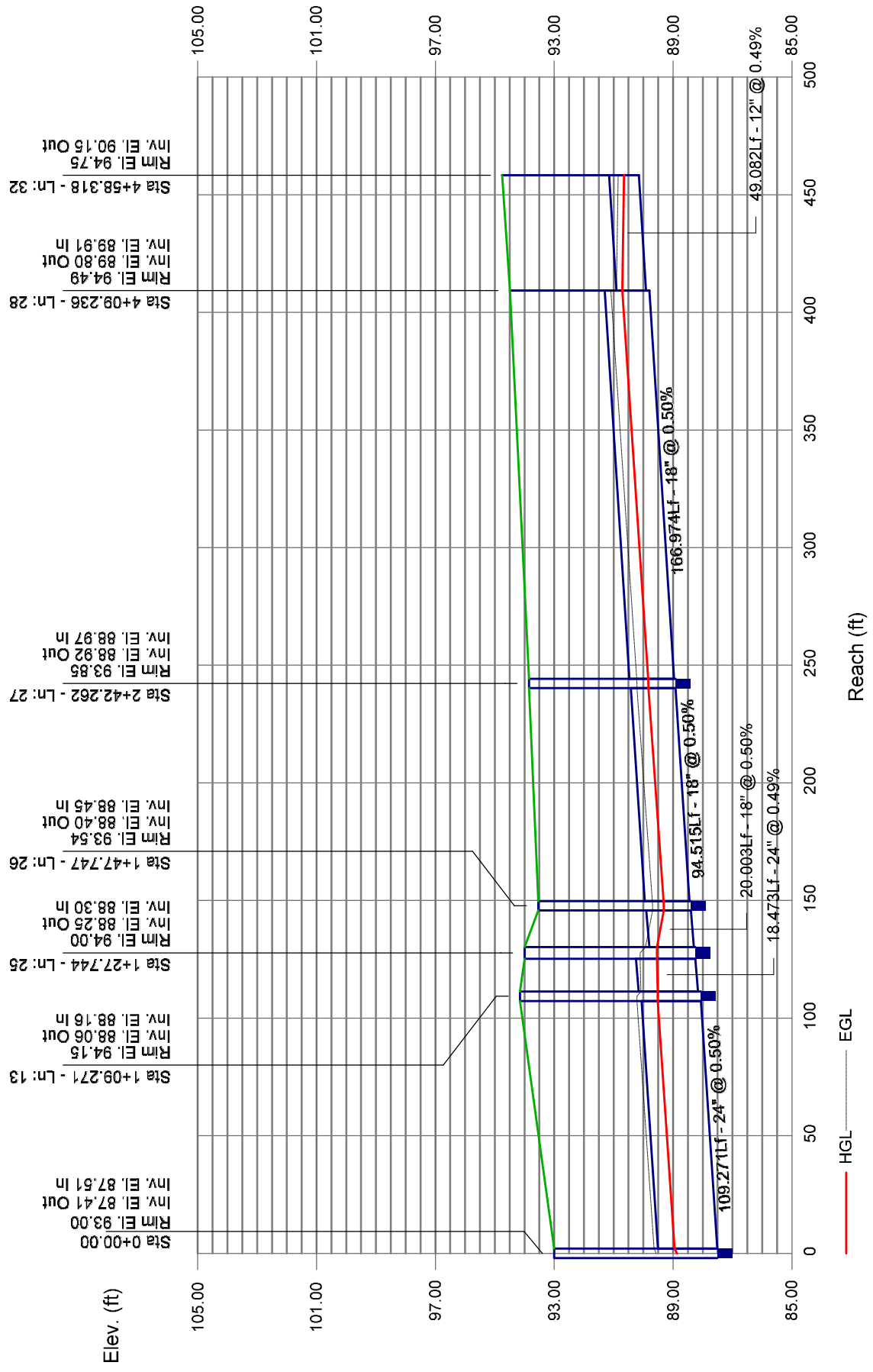

# Storm Sewer Profile

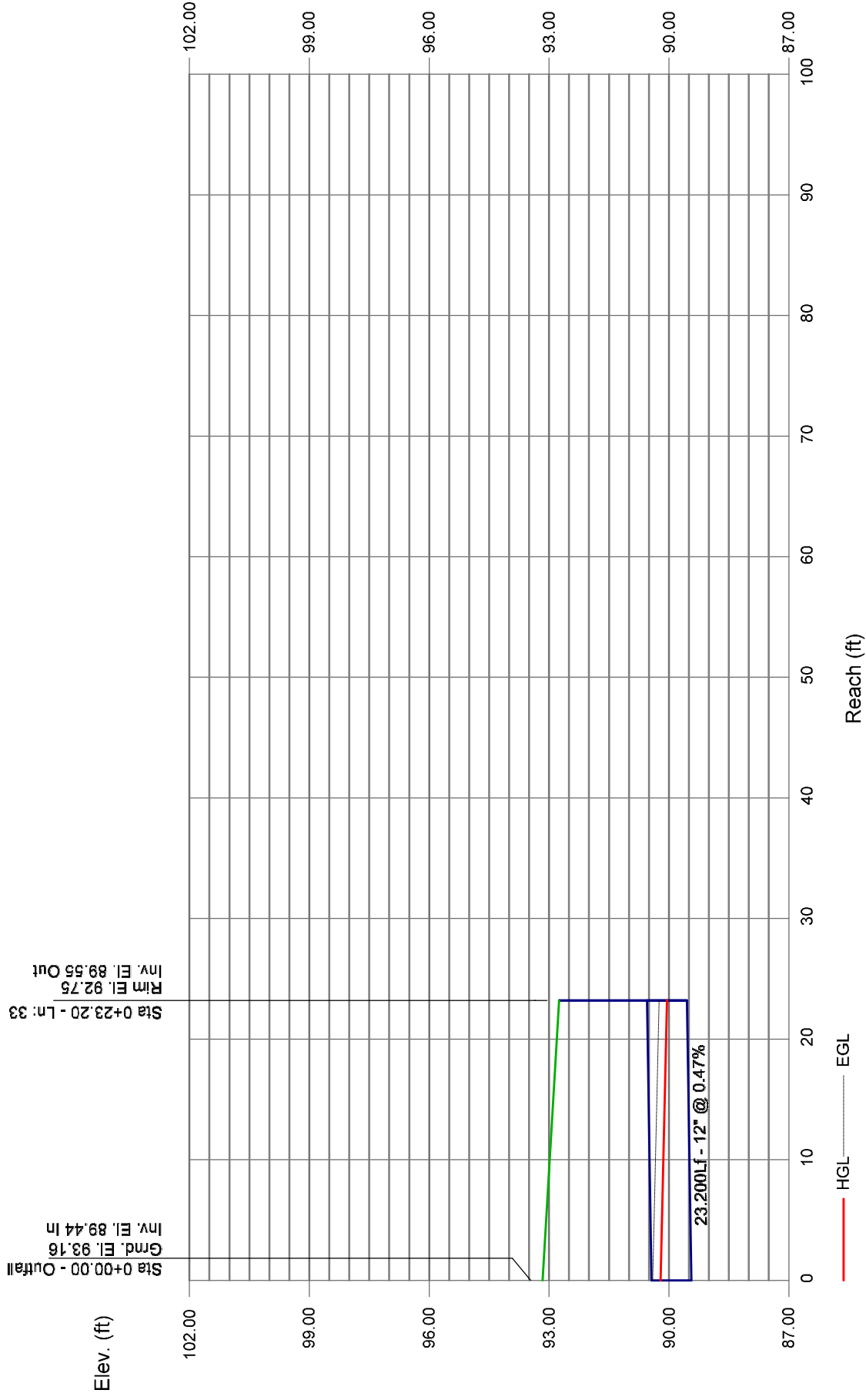

# Storm Sewer Profile

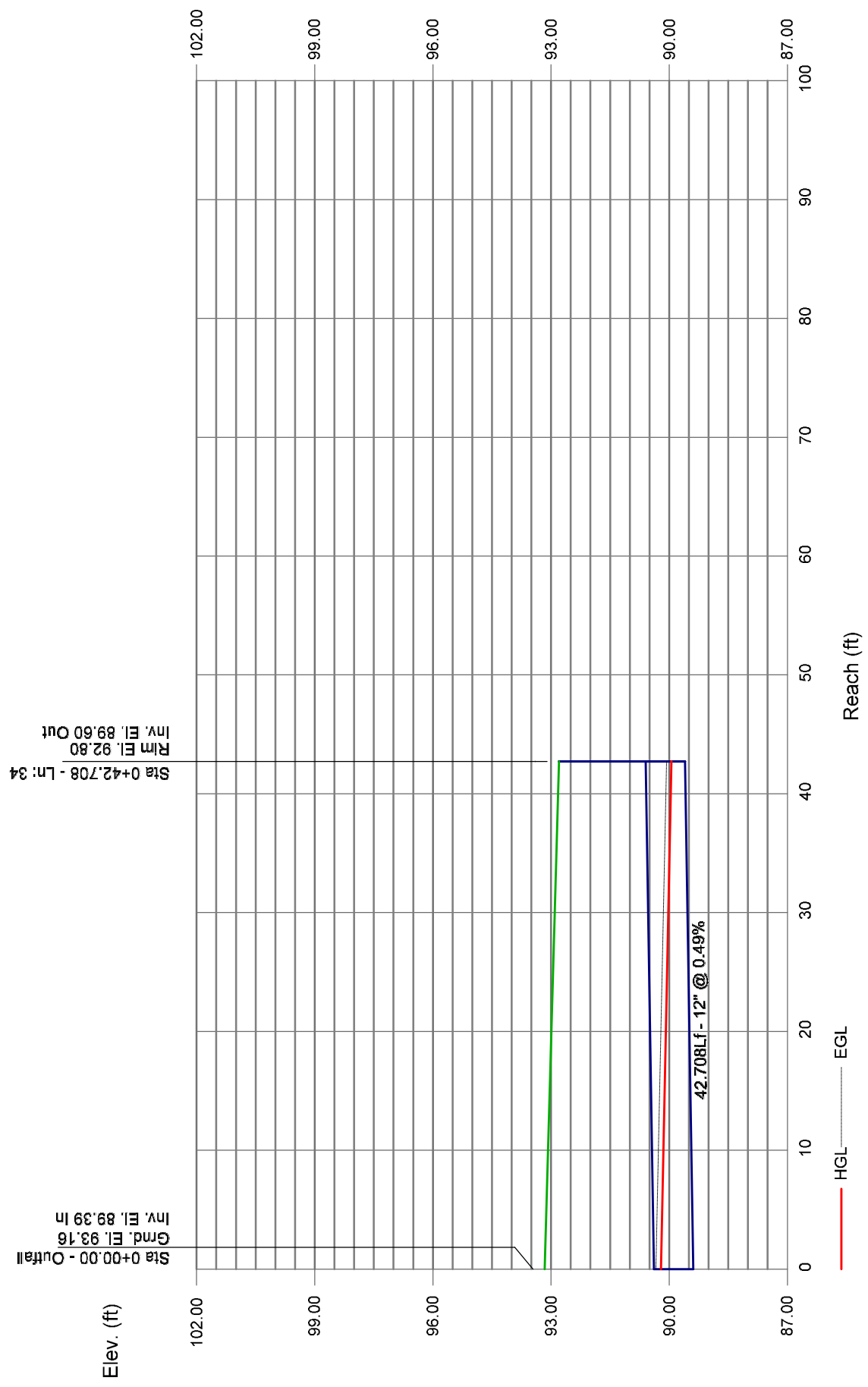



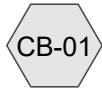

CB-01

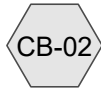

CB-02

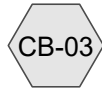

CB-03

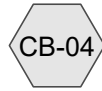

CB-04

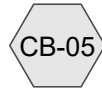

CB-05

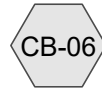

CB-06



CB-07



CB-08

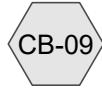

CB-09



CB-10



CB-11



CB-12



ECB-01



ECB-02



ECB-03



ECB-04



ECB-05



ECB-06



ECB-07



ECB-08



DMH-13



DMH-02



DMH-08

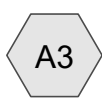

SUB-A3



BR-1

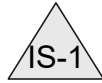

IS-1



SUB-A4



SUB-A2

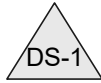

DS-1

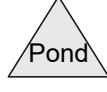
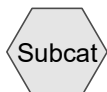

# Hydraflow 10-Yr Calcs

Prepared by Weston & Sampson

HydroCAD® 10.10-6a s/n 00455 © 2020 HydroCAD Software Solutions LLC

Printed 11/5/2021

Page 2

## Rainfall Events Listing (selected events)

Event#	Event Name	Storm Type	Curve	Mode	Duration (hours)	B/B	Depth (inches)	AMC
1	10-year	Type III 24-hr		Default	24.00	1	5.12	2

# Hydraflow 10-Yr Calcs

Prepared by Weston & Sampson

HydroCAD® 10.10-6a s/n 00455 © 2020 HydroCAD Software Solutions LLC

Printed 11/5/2021

Page 3

## Area Listing (all nodes)

Area (sq-ft)	CN	Description (subcatchment-numbers)
35,365	39	>75% Grass cover, Good, HSG A (A2, A3, A4, CB-01, CB-02, CB-03, CB-04, CB-05, CB-06, CB-07, ECB-01, ECB-02, ECB-03, ECB-04, ECB-05, ECB-06, ECB-07, ECB-08)
71,772	61	>75% Grass cover, Good, HSG B (A2, A3, A4, CB-01, CB-07, CB-08, CB-09, CB-10, CB-11, CB-12, DMH-13, ECB-02, ECB-07, ECB-08)
81,590	98	Paved Impervious, HSG A (A2, A3, A4, CB-01, CB-02, CB-03, CB-04, CB-05, CB-06, CB-07, ECB-01, ECB-02, ECB-03, ECB-04, ECB-06, ECB-08)
114,891	98	Paved Impervious, HSG B (A2, A3, A4, CB-01, CB-05, CB-07, CB-08, CB-09, CB-10, CB-11, CB-12, DMH-13, ECB-02, ECB-06, ECB-07, ECB-08)
12,242	98	Roofs, HSG A (A4, CB-01, CB-02, CB-03, CB-05, DMH-08, ECB-06)
68,974	98	Roofs, HSG B (A2, A3, A4, CB-01, CB-05, CB-07, CB-08, CB-09, CB-10, CB-11, CB-12, DMH-02, DMH-08, DMH-13, ECB-06)
40,559	30	Woods, Good, HSG A (A2, CB-06, CB-07, ECB-05, ECB-06, ECB-07, ECB-08)
20,584	55	Woods, Good, HSG B (A2, CB-07, CB-09, CB-10, CB-11, CB-12, DMH-13, ECB-07, ECB-08)
<b>445,977</b>	<b>79</b>	<b>TOTAL AREA</b>

# Hydraflow 10-Yr Calcs

Prepared by Weston & Sampson

HydroCAD® 10.10-6a s/n 00455 © 2020 HydroCAD Software Solutions LLC

Printed 11/5/2021

Page 4

## Soil Listing (all nodes)

Area (sq-ft)	Soil Group	Subcatchment Numbers
169,756	HSG A	A2, A3, A4, CB-01, CB-02, CB-03, CB-04, CB-05, CB-06, CB-07, DMH-08, ECB-01, ECB-02, ECB-03, ECB-04, ECB-05, ECB-06, ECB-07, ECB-08
276,221	HSG B	A2, A3, A4, CB-01, CB-05, CB-07, CB-08, CB-09, CB-10, CB-11, CB-12, DMH-02, DMH-08, DMH-13, ECB-02, ECB-06, ECB-07, ECB-08
0	HSG C	
0	HSG D	
0	Other	
<b>445,977</b>		<b>TOTAL AREA</b>

# Hydraflow 10-Yr Calcs

Prepared by Weston & Sampson

HydroCAD® 10.10-6a s/n 00455 © 2020 HydroCAD Software Solutions LLC

Printed 11/5/2021

Page 5

## Ground Covers (all nodes)

HSG-A (sq-ft)	HSG-B (sq-ft)	HSG-C (sq-ft)	HSG-D (sq-ft)	Other (sq-ft)	Total (sq-ft)	Ground Cover
35,365	71,772	0	0	0	107,137	>75% Grass cover, Good
81,590	114,891	0	0	0	196,481	Paved Impervious
12,242	68,974	0	0	0	81,216	Roofs
40,559	20,584	0	0	0	61,143	Woods, Good
<b>169,756</b>	<b>276,221</b>	<b>0</b>	<b>0</b>	<b>0</b>	<b>445,977</b>	<b>TOTAL AREA</b>

# Hydraflow 10-Yr Calcs

Prepared by Weston & Sampson

HydroCAD® 10.10-6a s/n 00455 © 2020 HydroCAD Software Solutions LLC

Type III 24-hr 10-year Rainfall=5.12"

Printed 11/5/2021

Page 6

Time span=1.00-36.00 hrs, dt=0.01 hrs, 3501 points  
Runoff by SCS TR-20 method, UH=SCS, Weighted-CN  
Reach routing by Dyn-Stor-Ind method - Pond routing by Dyn-Stor-Ind method

<b>SubcatchmentA2: SUB-A2</b>	Runoff Area=35,193 sf 61.85% Impervious Runoff Depth=2.72" Flow Length=160' Tc=8.9 min CN=77 Runoff=2.34 cfs 7,988 cf
<b>SubcatchmentA3: SUB-A3</b>	Runoff Area=16,500 sf 77.45% Impervious Runoff Depth=3.58" Tc=6.0 min CN=86 Runoff=1.57 cfs 4,921 cf
<b>SubcatchmentA4: SUB-A4</b>	Runoff Area=43,945 sf 87.97% Impervious Runoff Depth=4.21" Tc=6.0 min CN=92 Runoff=4.71 cfs 15,405 cf
<b>SubcatchmentCB-01: CB-01</b>	Runoff Area=9,767 sf 72.68% Impervious Runoff Depth=3.58" Tc=6.0 min CN=86 Runoff=0.93 cfs 2,913 cf
<b>SubcatchmentCB-02: CB-02</b>	Runoff Area=5,670 sf 87.27% Impervious Runoff Depth=3.99" Tc=6.0 min CN=90 Runoff=0.59 cfs 1,886 cf
<b>SubcatchmentCB-03: CB-03</b>	Runoff Area=7,672 sf 97.72% Impervious Runoff Depth=4.77" Tc=6.0 min CN=97 Runoff=0.88 cfs 3,048 cf
<b>SubcatchmentCB-04: CB-04</b>	Runoff Area=13,441 sf 92.51% Impervious Runoff Depth=4.43" Tc=6.0 min CN=94 Runoff=1.49 cfs 4,958 cf
<b>SubcatchmentCB-05: CB-05</b>	Runoff Area=7,280 sf 92.83% Impervious Runoff Depth=4.43" Tc=6.0 min CN=94 Runoff=0.81 cfs 2,685 cf
<b>SubcatchmentCB-06: CB-06</b>	Runoff Area=8,861 sf 33.98% Impervious Runoff Depth=1.04" Flow Length=136' Tc=7.4 min CN=55 Runoff=0.19 cfs 768 cf
<b>SubcatchmentCB-07: CB-07</b>	Runoff Area=21,842 sf 39.50% Impervious Runoff Depth=1.66" Flow Length=160' Tc=8.9 min CN=64 Runoff=0.83 cfs 3,020 cf
<b>SubcatchmentCB-08: CB-08</b>	Runoff Area=13,351 sf 98.42% Impervious Runoff Depth=4.77" Tc=6.0 min CN=97 Runoff=1.53 cfs 5,303 cf
<b>SubcatchmentCB-09: CB-09</b>	Runoff Area=16,812 sf 64.49% Impervious Runoff Depth=3.48" Tc=6.0 min CN=85 Runoff=1.56 cfs 4,874 cf
<b>SubcatchmentCB-10: CB-10</b>	Runoff Area=16,812 sf 64.49% Impervious Runoff Depth=3.48" Tc=6.0 min CN=85 Runoff=1.56 cfs 4,874 cf
<b>SubcatchmentCB-11: CB-11</b>	Runoff Area=16,812 sf 64.49% Impervious Runoff Depth=3.48" Tc=6.0 min CN=85 Runoff=1.56 cfs 4,874 cf
<b>SubcatchmentCB-12: CB-12</b>	Runoff Area=16,812 sf 64.49% Impervious Runoff Depth=3.48" Tc=6.0 min CN=85 Runoff=1.56 cfs 4,874 cf
<b>SubcatchmentDMH-02: DMH-02</b>	Runoff Area=1,652 sf 100.00% Impervious Runoff Depth>4.88" Tc=6.0 min CN=98 Runoff=0.19 cfs 672 cf

# Hydraflow 10-Yr Calcs

Prepared by Weston & Sampson

HydroCAD® 10.10-6a s/n 00455 © 2020 HydroCAD Software Solutions LLC

Type III 24-hr 10-year Rainfall=5.12"

Printed 11/5/2021

Page 7

<b>SubcatchmentDMH-08: DMH-08</b>	Runoff Area=9,605 sf 100.00% Impervious Runoff Depth>4.88" Tc=6.0 min CN=98 Runoff=1.10 cfs 3,908 cf
<b>SubcatchmentDMH-13: DMH-13</b>	Runoff Area=67,238 sf 62.52% Impervious Runoff Depth=3.38" Tc=6.0 min CN=84 Runoff=6.07 cfs 18,941 cf
<b>SubcatchmentECB-01: ECB-01</b>	Runoff Area=3,897 sf 46.60% Impervious Runoff Depth=1.81" Tc=6.0 min CN=66 Runoff=0.18 cfs 588 cf
<b>SubcatchmentECB-02: ECB-02</b>	Runoff Area=3,256 sf 75.03% Impervious Runoff Depth=3.58" Tc=6.0 min CN=86 Runoff=0.31 cfs 971 cf
<b>SubcatchmentECB-03: ECB-03</b>	Runoff Area=3,897 sf 46.60% Impervious Runoff Depth=1.81" Tc=6.0 min CN=66 Runoff=0.18 cfs 588 cf
<b>SubcatchmentECB-04: ECB-04</b>	Runoff Area=4,860 sf 52.67% Impervious Runoff Depth=2.13" Tc=6.0 min CN=70 Runoff=0.27 cfs 861 cf
<b>SubcatchmentECB-05: ECB-05</b>	Runoff Area=10,324 sf 0.00% Impervious Runoff Depth=0.10" Flow Length=136' Tc=7.4 min CN=35 Runoff=0.00 cfs 85 cf
<b>SubcatchmentECB-06: ECB-06</b>	Runoff Area=26,232 sf 78.16% Impervious Runoff Depth=3.48" Flow Length=136' Tc=7.4 min CN=85 Runoff=2.31 cfs 7,605 cf
<b>SubcatchmentECB-07: ECB-07</b>	Runoff Area=19,435 sf 17.60% Impervious Runoff Depth=1.37" Tc=6.0 min CN=60 Runoff=0.65 cfs 2,222 cf
<b>SubcatchmentECB-08: ECB-08</b>	Runoff Area=44,811 sf 26.24% Impervious Runoff Depth=1.24" Flow Length=463' Tc=12.7 min CN=58 Runoff=1.04 cfs 4,613 cf
<b>Pond BR-1: BR-1</b>	Peak Elev=100.93' Storage=760 cf Inflow=1.57 cfs 4,921 cf Primary=1.56 cfs 4,207 cf Secondary=0.00 cfs 0 cf Outflow=1.56 cfs 4,207 cf
<b>Pond DS-1: DS-1</b>	Peak Elev=90.24' Storage=859 cf Inflow=2.34 cfs 7,988 cf Outflow=2.32 cfs 7,987 cf
<b>Pond IS-1: IS-1</b>	Peak Elev=93.75' Storage=8,233 cf Inflow=6.27 cfs 19,612 cf Discarded=0.26 cfs 13,800 cf Primary=0.49 cfs 5,811 cf Outflow=0.75 cfs 19,612 cf

**Total Runoff Area = 445,977 sf Runoff Volume = 113,447 cf Average Runoff Depth = 3.05"**  
**37.73% Pervious = 168,280 sf 62.27% Impervious = 277,697 sf**

# Hydraflow 10-Yr Calcs

Prepared by Weston & Sampson

HydroCAD® 10.10-6a s/n 00455 © 2020 HydroCAD Software Solutions LLC

Type III 24-hr 10-year Rainfall=5.12"

Printed 11/5/2021

Page 8

## Summary for Subcatchment A2: SUB-A2

Runoff = 2.34 cfs @ 12.13 hrs, Volume= 7,988 cf, Depth= 2.72"  
 Routed to Pond DS-1 : DS-1

Runoff by SCS TR-20 method, UH=SCS, Weighted-CN, Time Span= 1.00-36.00 hrs, dt= 0.01 hrs  
 Type III 24-hr 10-year Rainfall=5.12"

Area (sf)	CN	Description
* 23	98	Paved Impervious, HSG A
* 18,246	98	Paved Impervious, HSG B
3,498	98	Roofs, HSG B
1,694	39	>75% Grass cover, Good, HSG A
4,693	61	>75% Grass cover, Good, HSG B
6,952	30	Woods, Good, HSG A
87	55	Woods, Good, HSG B
35,193	77	Weighted Average
13,426		38.15% Pervious Area
21,767		61.85% Impervious Area

Tc (min)	Length (feet)	Slope (ft/ft)	Velocity (ft/sec)	Capacity (cfs)	Description
7.4	50	0.0700	0.11		<b>Sheet Flow,</b> Woods: Light underbrush n= 0.400 P2= 3.30"
0.5	33	0.0450	1.06		<b>Shallow Concentrated Flow,</b> Woodland Kv= 5.0 fps
0.9	59	0.0250	1.11		<b>Shallow Concentrated Flow,</b> Short Grass Pasture Kv= 7.0 fps
0.1	18	0.0150	2.49		<b>Shallow Concentrated Flow,</b> Paved Kv= 20.3 fps
8.9	160	Total			



# Hydraflow 10-Yr Calcs

Prepared by Weston & Sampson

HydroCAD® 10.10-6a s/n 00455 © 2020 HydroCAD Software Solutions LLC

Type III 24-hr 10-year Rainfall=5.12"

Printed 11/5/2021

Page 9

## Subcatchment A2: SUB-A2

Hydrograph

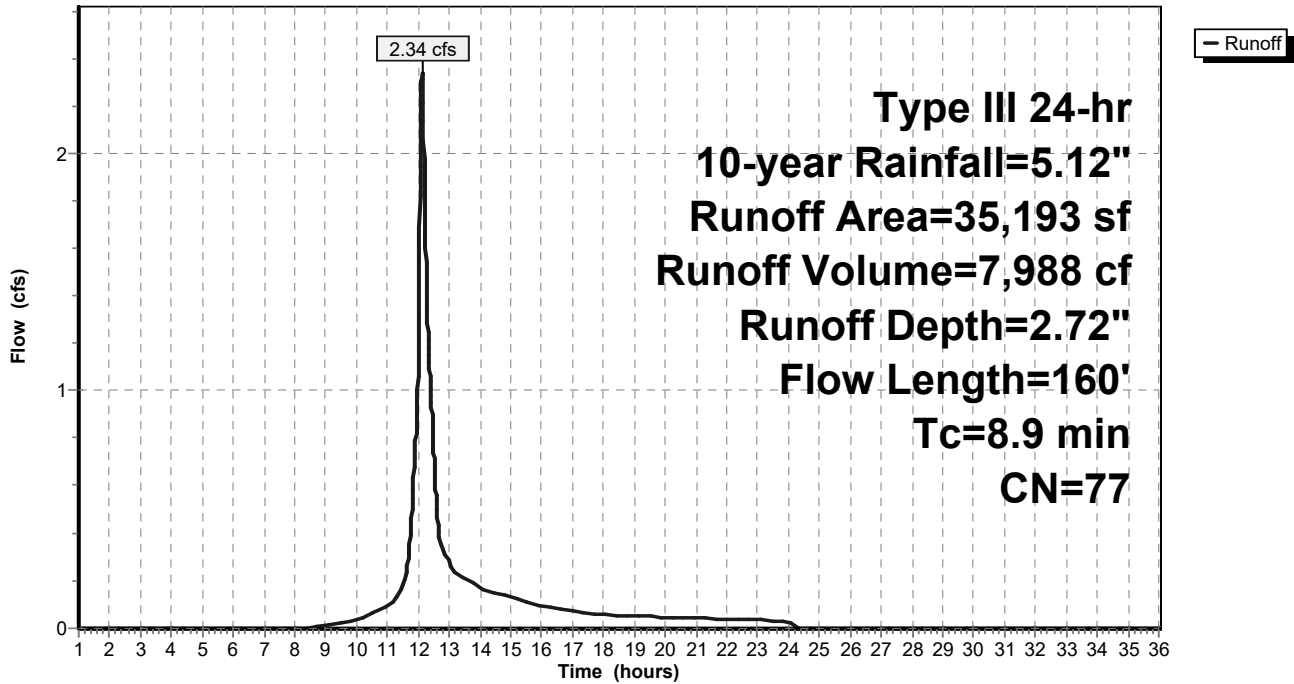

# Hydraflow 10-Yr Calcs

Prepared by Weston & Sampson

HydroCAD® 10.10-6a s/n 00455 © 2020 HydroCAD Software Solutions LLC

Type III 24-hr 10-year Rainfall=5.12"

Printed 11/5/2021

Page 10

## Summary for Subcatchment A3: SUB-A3

Runoff = 1.57 cfs @ 12.09 hrs, Volume= 4,921 cf, Depth= 3.58"  
 Routed to Pond BR-1 : BR-1

Runoff by SCS TR-20 method, UH=SCS, Weighted-CN, Time Span= 1.00-36.00 hrs, dt= 0.01 hrs  
 Type III 24-hr 10-year Rainfall=5.12"

	Area (sf)	CN	Description
*	4,196	98	Paved Impervious, HSG A
*	1,717	98	Paved Impervious, HSG B
	6,866	98	Roofs, HSG B
	2,808	39	>75% Grass cover, Good, HSG A
	913	61	>75% Grass cover, Good, HSG B
	16,500	86	Weighted Average
	3,721		22.55% Pervious Area
	12,779		77.45% Impervious Area

Tc (min)	Length (feet)	Slope (ft/ft)	Velocity (ft/sec)	Capacity (cfs)	Description
6.0					Direct Entry,

## Subcatchment A3: SUB-A3

Hydrograph

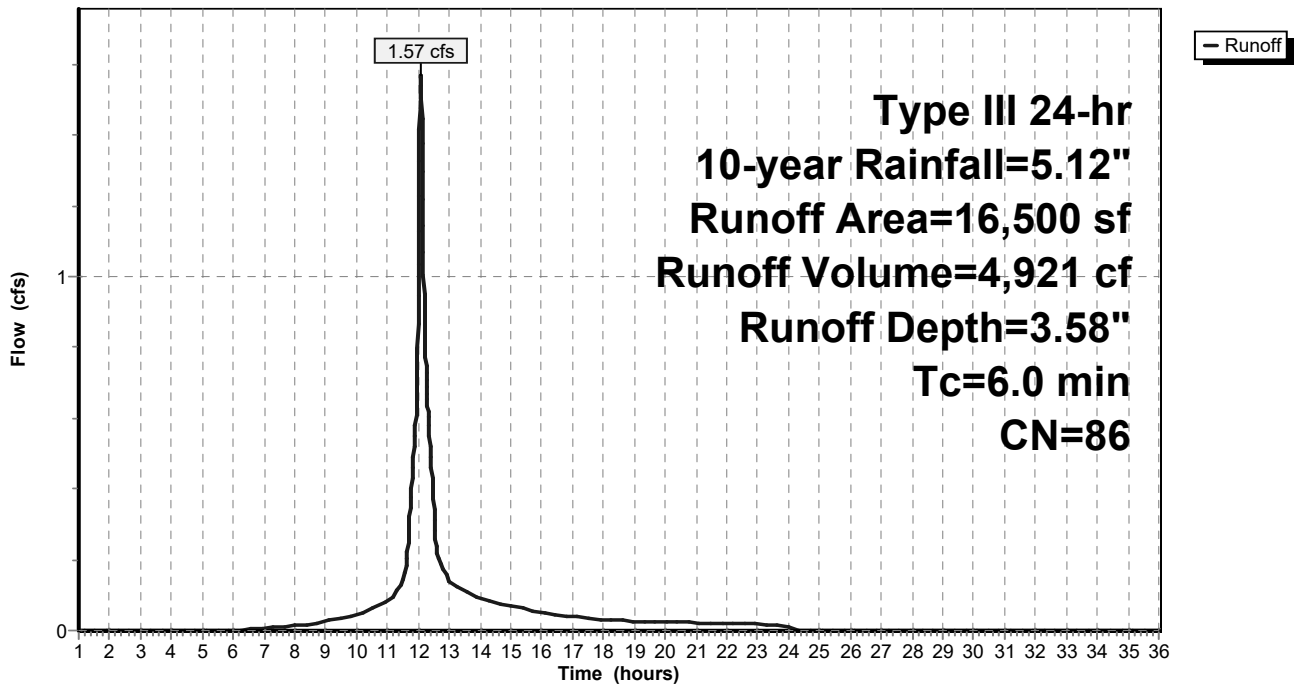

# Hydraflow 10-Yr Calcs

Prepared by Weston & Sampson

HydroCAD® 10.10-6a s/n 00455 © 2020 HydroCAD Software Solutions LLC

Type III 24-hr 10-year Rainfall=5.12"

Printed 11/5/2021

Page 11

## Summary for Subcatchment A4: SUB-A4

Runoff = 4.71 cfs @ 12.08 hrs, Volume= 15,405 cf, Depth= 4.21"  
 Routed to Pond IS-1 : IS-1

Runoff by SCS TR-20 method, UH=SCS, Weighted-CN, Time Span= 1.00-36.00 hrs, dt= 0.01 hrs  
 Type III 24-hr 10-year Rainfall=5.12"

	Area (sf)	CN	Description
*	28,479	98	Paved Impervious, HSG A
*	4,701	98	Paved Impervious, HSG B
	3,540	98	Roofs, HSG A
	1,940	98	Roofs, HSG B
	3,675	39	>75% Grass cover, Good, HSG A
	1,610	61	>75% Grass cover, Good, HSG B
	43,945	92	Weighted Average
	5,285		12.03% Pervious Area
	38,660		87.97% Impervious Area

Tc (min)	Length (feet)	Slope (ft/ft)	Velocity (ft/sec)	Capacity (cfs)	Description
6.0					Direct Entry,

## Subcatchment A4: SUB-A4

Hydrograph

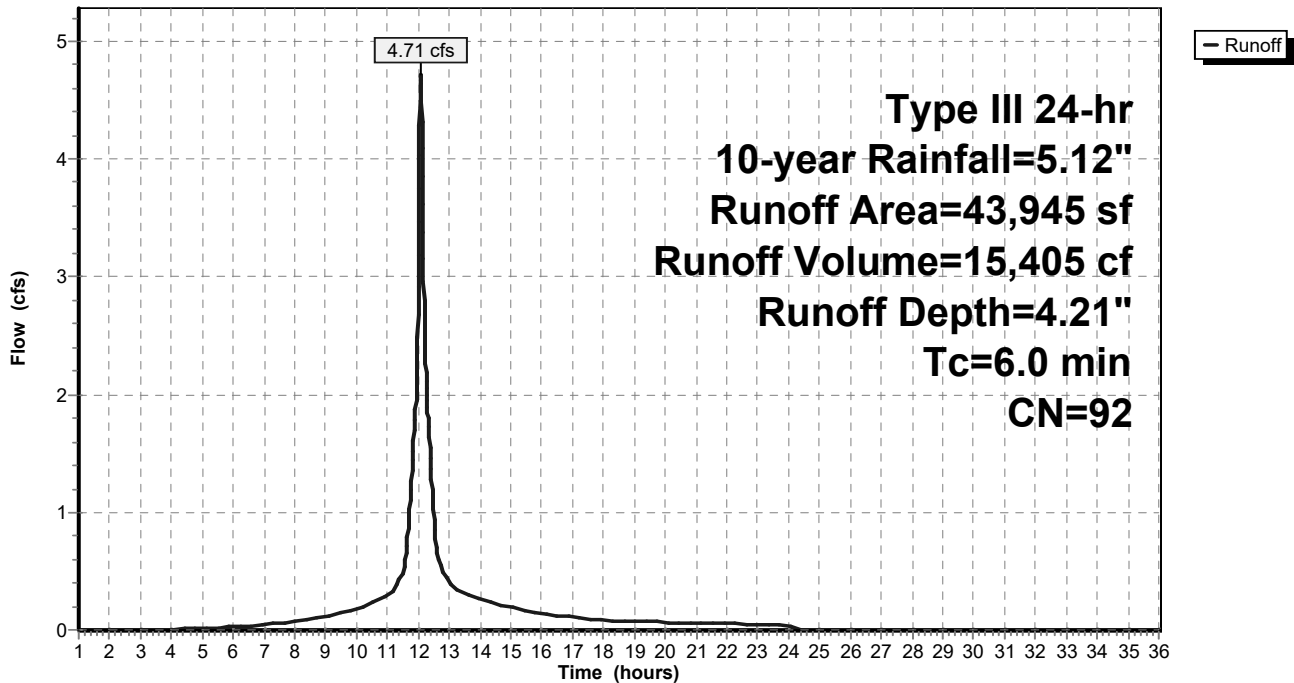

# Hydraflow 10-Yr Calcs

Prepared by Weston & Sampson

HydroCAD® 10.10-6a s/n 00455 © 2020 HydroCAD Software Solutions LLC

Type III 24-hr 10-year Rainfall=5.12"

Printed 11/5/2021

Page 12

## Summary for Subcatchment CB-01: CB-01

Runoff = 0.93 cfs @ 12.09 hrs, Volume= 2,913 cf, Depth= 3.58"

Runoff by SCS TR-20 method, UH=SCS, Weighted-CN, Time Span= 1.00-36.00 hrs, dt= 0.01 hrs  
Type III 24-hr 10-year Rainfall=5.12"

Area (sf)	CN	Description
* 849	98	Paved Impervious, HSG A
* 4,591	98	Paved Impervious, HSG B
1,178	98	Roofs, HSG A
481	98	Roofs, HSG B
1,047	39	>75% Grass cover, Good, HSG A
1,621	61	>75% Grass cover, Good, HSG B
9,767	86	Weighted Average
2,668		27.32% Pervious Area
7,099		72.68% Impervious Area

Tc (min)	Length (feet)	Slope (ft/ft)	Velocity (ft/sec)	Capacity (cfs)	Description
6.0					Direct Entry,

## Subcatchment CB-01: CB-01

Hydrograph

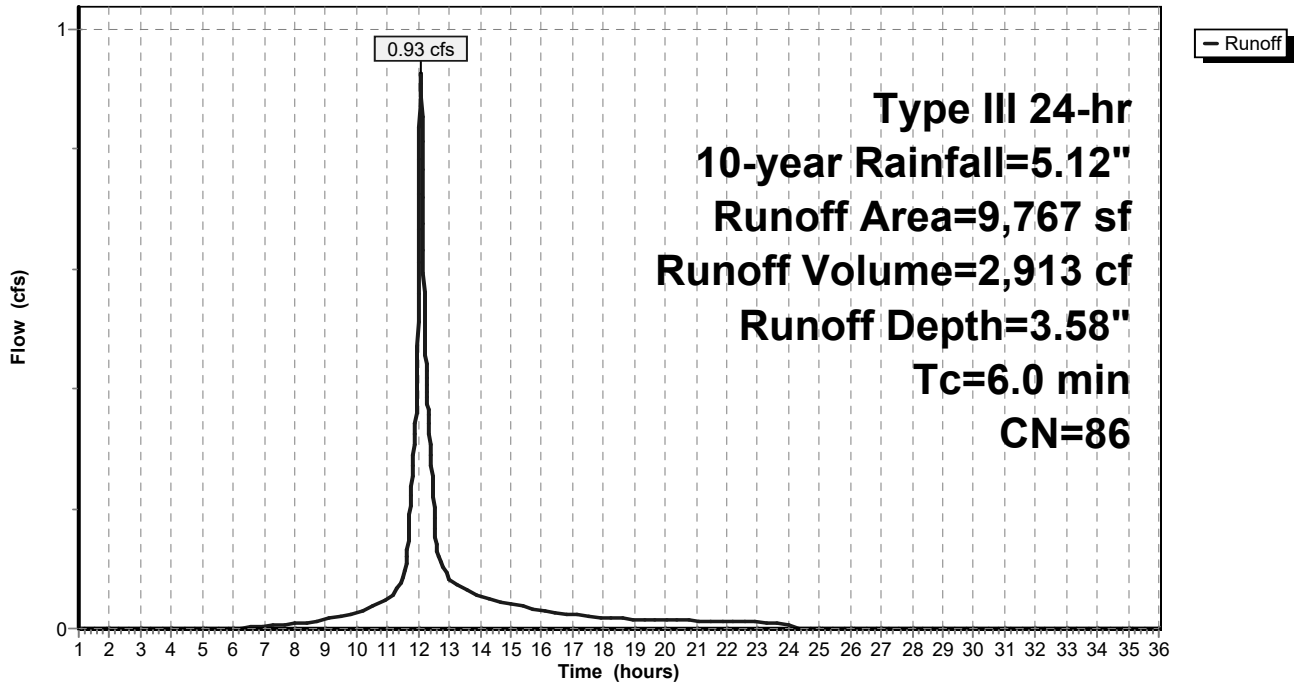

# Hydraflow 10-Yr Calcs

Prepared by Weston & Sampson

HydroCAD® 10.10-6a s/n 00455 © 2020 HydroCAD Software Solutions LLC

Type III 24-hr 10-year Rainfall=5.12"

Printed 11/5/2021

Page 13

## Summary for Subcatchment CB-02: CB-02

Runoff = 0.59 cfs @ 12.09 hrs, Volume= 1,886 cf, Depth= 3.99"

Runoff by SCS TR-20 method, UH=SCS, Weighted-CN, Time Span= 1.00-36.00 hrs, dt= 0.01 hrs  
Type III 24-hr 10-year Rainfall=5.12"

	Area (sf)	CN	Description
*	4,323	98	Paved Impervious, HSG A
	625	98	Roofs, HSG A
	722	39	>75% Grass cover, Good, HSG A
	5,670	90	Weighted Average
	722		12.73% Pervious Area
	4,948		87.27% Impervious Area

Tc (min)	Length (feet)	Slope (ft/ft)	Velocity (ft/sec)	Capacity (cfs)	Description
6.0					Direct Entry,

## Subcatchment CB-02: CB-02

Hydrograph

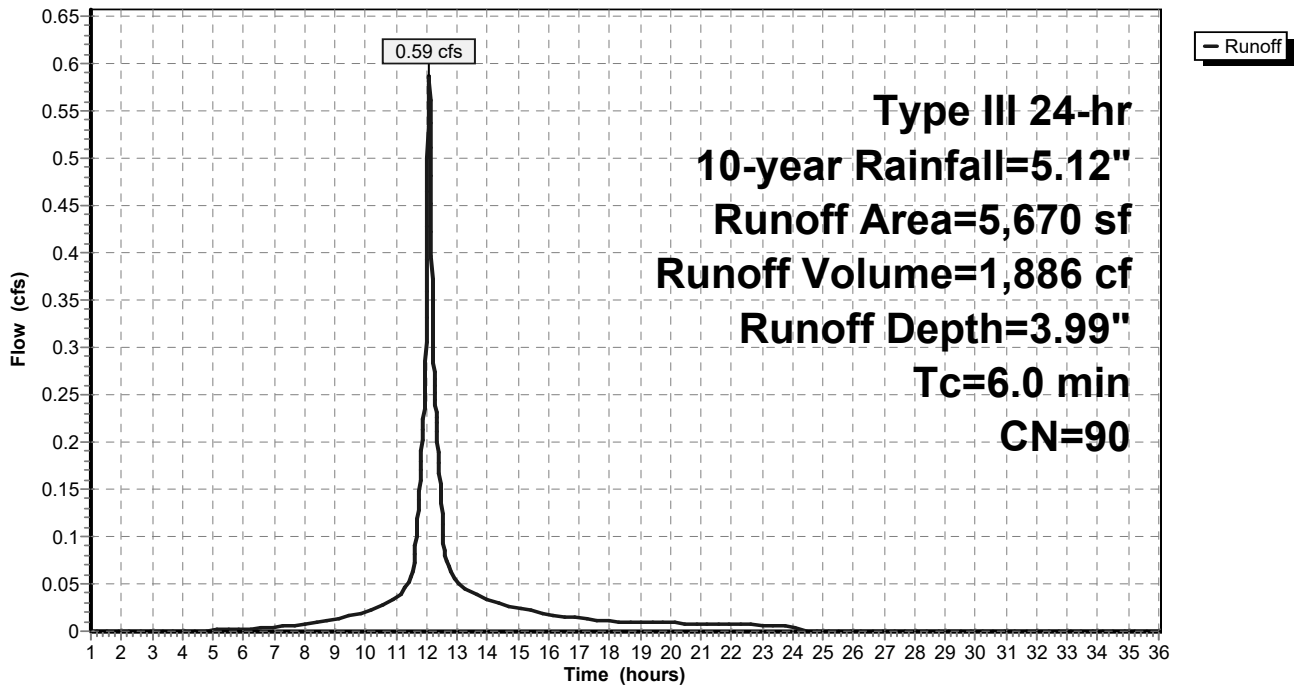

# Hydraflow 10-Yr Calcs

Prepared by Weston & Sampson

HydroCAD® 10.10-6a s/n 00455 © 2020 HydroCAD Software Solutions LLC

Type III 24-hr 10-year Rainfall=5.12"

Printed 11/5/2021

Page 14

## Summary for Subcatchment CB-03: CB-03

Runoff = 0.88 cfs @ 12.08 hrs, Volume= 3,048 cf, Depth= 4.77"

Runoff by SCS TR-20 method, UH=SCS, Weighted-CN, Time Span= 1.00-36.00 hrs, dt= 0.01 hrs  
Type III 24-hr 10-year Rainfall=5.12"

	Area (sf)	CN	Description
*	7,042	98	Paved Impervious, HSG A
	455	98	Roofs, HSG A
	175	39	>75% Grass cover, Good, HSG A
	7,672	97	Weighted Average
	175		2.28% Pervious Area
	7,497		97.72% Impervious Area

Tc (min)	Length (feet)	Slope (ft/ft)	Velocity (ft/sec)	Capacity (cfs)	Description
6.0					Direct Entry,

## Subcatchment CB-03: CB-03

Hydrograph

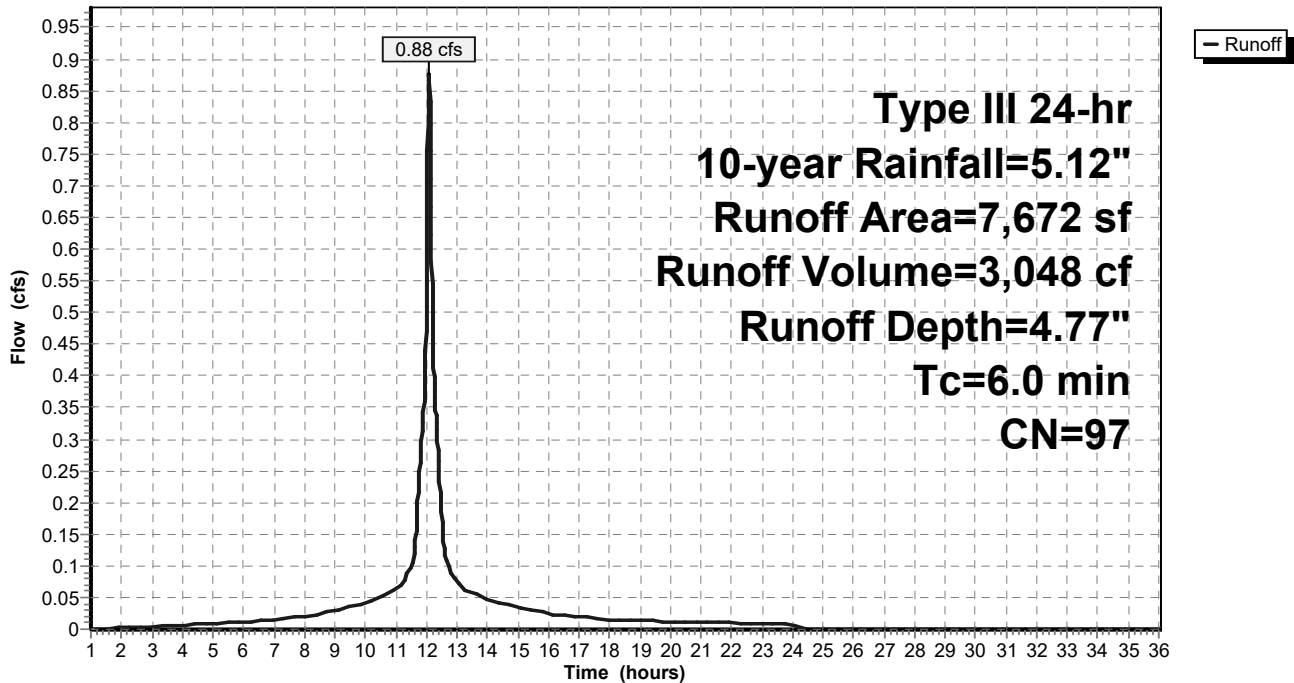

# Hydraflow 10-Yr Calcs

Prepared by Weston & Sampson

HydroCAD® 10.10-6a s/n 00455 © 2020 HydroCAD Software Solutions LLC

Type III 24-hr 10-year Rainfall=5.12"

Printed 11/5/2021

Page 15

## Summary for Subcatchment CB-04: CB-04

Runoff = 1.49 cfs @ 12.08 hrs, Volume= 4,958 cf, Depth= 4.43"

Runoff by SCS TR-20 method, UH=SCS, Weighted-CN, Time Span= 1.00-36.00 hrs, dt= 0.01 hrs  
Type III 24-hr 10-year Rainfall=5.12"

	Area (sf)	CN	Description
*	12,434	98	Paved Impervious, HSG A
	1,007	39	>75% Grass cover, Good, HSG A
	13,441	94	Weighted Average
	1,007		7.49% Pervious Area
	12,434		92.51% Impervious Area

Tc (min)	Length (feet)	Slope (ft/ft)	Velocity (ft/sec)	Capacity (cfs)	Description
6.0					Direct Entry,

## Subcatchment CB-04: CB-04

Hydrograph

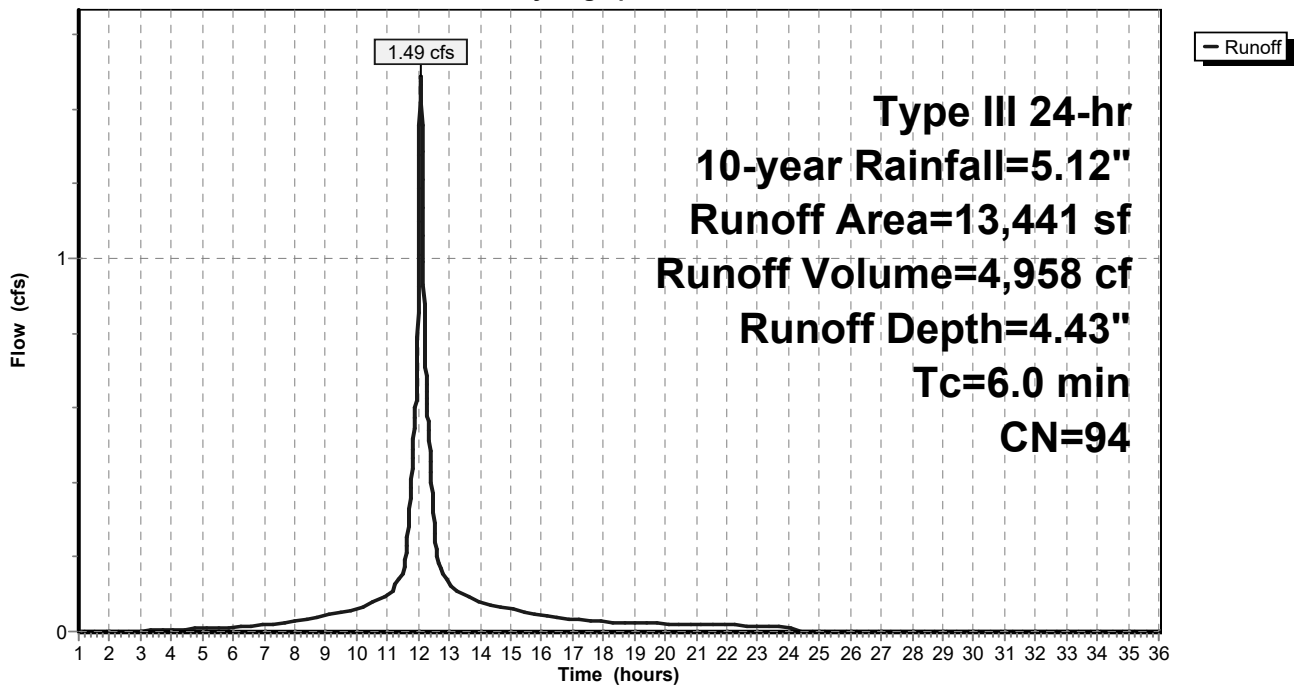

# Hydraflow 10-Yr Calcs

Prepared by Weston & Sampson

HydroCAD® 10.10-6a s/n 00455 © 2020 HydroCAD Software Solutions LLC

Type III 24-hr 10-year Rainfall=5.12"

Printed 11/5/2021

Page 16

## Summary for Subcatchment CB-05: CB-05

Runoff = 0.81 cfs @ 12.08 hrs, Volume= 2,685 cf, Depth= 4.43"

Runoff by SCS TR-20 method, UH=SCS, Weighted-CN, Time Span= 1.00-36.00 hrs, dt= 0.01 hrs  
Type III 24-hr 10-year Rainfall=5.12"

	Area (sf)	CN	Description
*	3,881	98	Paved Impervious, HSG A
*	137	98	Paved Impervious, HSG B
	1,275	98	Roofs, HSG A
	1,465	98	Roofs, HSG B
	522	39	>75% Grass cover, Good, HSG A
	7,280	94	Weighted Average
	522		7.17% Pervious Area
	6,758		92.83% Impervious Area

Tc (min)	Length (feet)	Slope (ft/ft)	Velocity (ft/sec)	Capacity (cfs)	Description
6.0					Direct Entry,

## Subcatchment CB-05: CB-05

Hydrograph

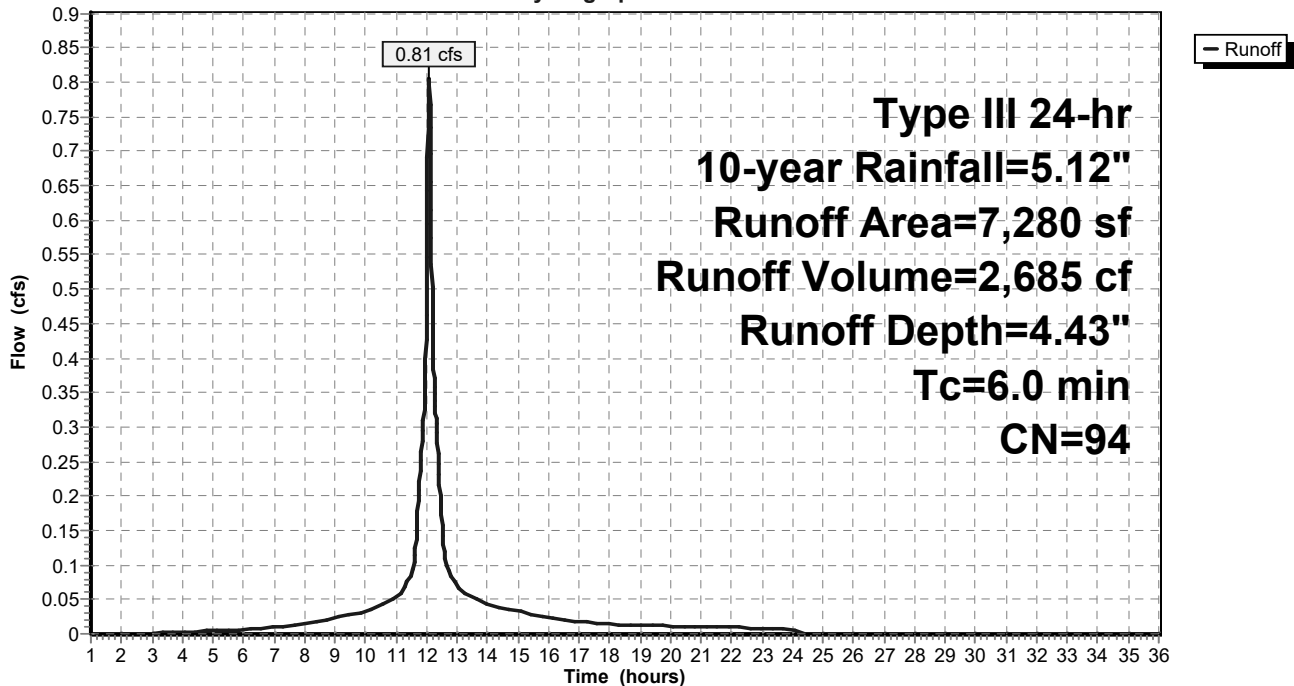



# Hydraflow 10-Yr Calcs

Prepared by Weston & Sampson

HydroCAD® 10.10-6a s/n 00455 © 2020 HydroCAD Software Solutions LLC

Type III 24-hr 10-year Rainfall=5.12"

Printed 11/5/2021

Page 17

## Summary for Subcatchment CB-06: CB-06

Runoff = 0.19 cfs @ 12.13 hrs, Volume= 768 cf, Depth= 1.04"

Runoff by SCS TR-20 method, UH=SCS, Weighted-CN, Time Span= 1.00-36.00 hrs, dt= 0.01 hrs  
Type III 24-hr 10-year Rainfall=5.12"

Area (sf)	CN	Description
* 3,011	98	Paved Impervious, HSG A
1,950	39	>75% Grass cover, Good, HSG A
3,900	30	Woods, Good, HSG A
8,861	55	Weighted Average
5,850		66.02% Pervious Area
3,011		33.98% Impervious Area

Tc (min)	Length (feet)	Slope (ft/ft)	Velocity (ft/sec)	Capacity (cfs)	Description
6.4	50	0.1000	0.13		<b>Sheet Flow,</b> Woods: Light underbrush n= 0.400 P2= 3.30"
0.7	52	0.0570	1.19		<b>Shallow Concentrated Flow,</b> Woodland Kv= 5.0 fps
0.3	34	0.0580	1.69		<b>Shallow Concentrated Flow,</b> Short Grass Pasture Kv= 7.0 fps
7.4	136	Total			

## Subcatchment CB-06: CB-06

Hydrograph

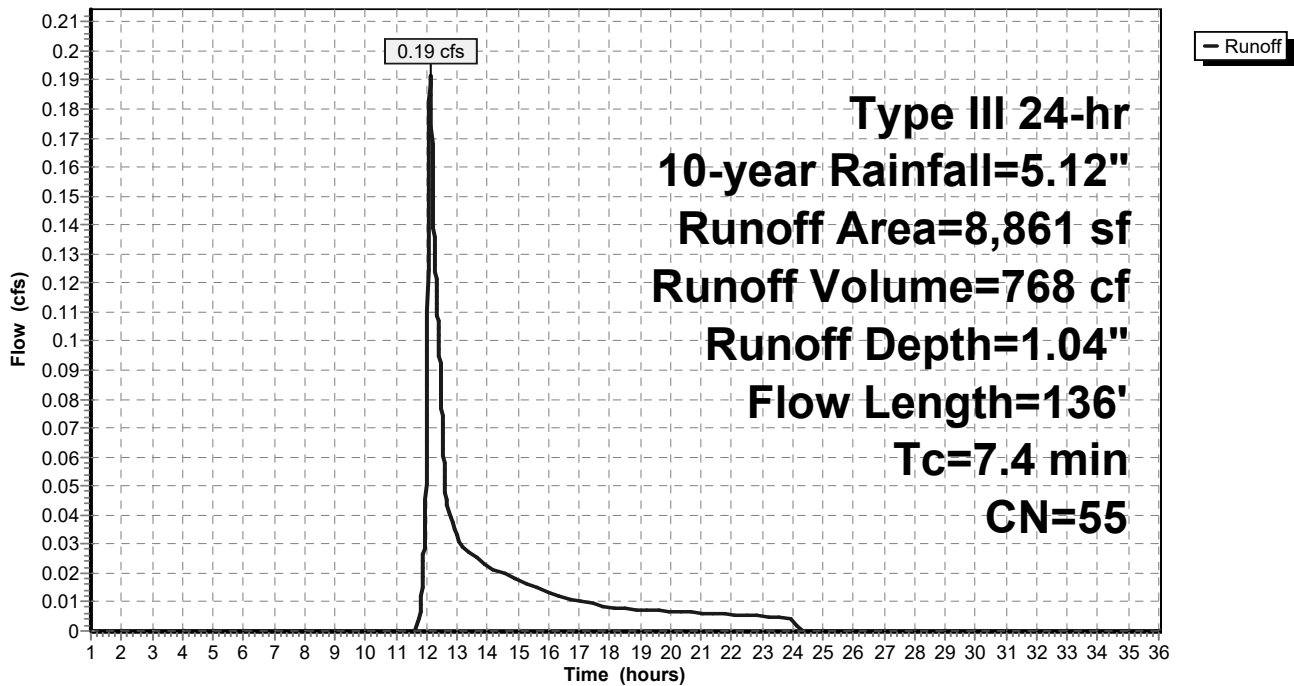

# Hydraflow 10-Yr Calcs

Prepared by Weston & Sampson

HydroCAD® 10.10-6a s/n 00455 © 2020 HydroCAD Software Solutions LLC

Type III 24-hr 10-year Rainfall=5.12"

Printed 11/5/2021

Page 18

## Summary for Subcatchment CB-07: CB-07

Runoff = 0.83 cfs @ 12.13 hrs, Volume= 3,020 cf, Depth= 1.66"

Runoff by SCS TR-20 method, UH=SCS, Weighted-CN, Time Span= 1.00-36.00 hrs, dt= 0.01 hrs  
Type III 24-hr 10-year Rainfall=5.12"

Area (sf)	CN	Description
* 23	98	Paved Impervious, HSG A
* 6,419	98	Paved Impervious, HSG B
2,185	98	Roofs, HSG B
1,694	39	>75% Grass cover, Good, HSG A
4,482	61	>75% Grass cover, Good, HSG B
6,952	30	Woods, Good, HSG A
87	55	Woods, Good, HSG B
21,842	64	Weighted Average
13,215		60.50% Pervious Area
8,627		39.50% Impervious Area

Tc (min)	Length (feet)	Slope (ft/ft)	Velocity (ft/sec)	Capacity (cfs)	Description
7.4	50	0.0700	0.11		<b>Sheet Flow,</b> Woods: Light underbrush n= 0.400 P2= 3.30"
0.5	33	0.0450	1.06		<b>Shallow Concentrated Flow,</b> Woodland Kv= 5.0 fps
0.9	59	0.0250	1.11		<b>Shallow Concentrated Flow,</b> Short Grass Pasture Kv= 7.0 fps
0.1	18	0.0150	2.49		<b>Shallow Concentrated Flow,</b> Paved Kv= 20.3 fps
8.9	160	Total			

# Hydraflow 10-Yr Calcs

Prepared by Weston & Sampson

HydroCAD® 10.10-6a s/n 00455 © 2020 HydroCAD Software Solutions LLC

Type III 24-hr 10-year Rainfall=5.12"

Printed 11/5/2021

Page 19

## Subcatchment CB-07: CB-07

Hydrograph

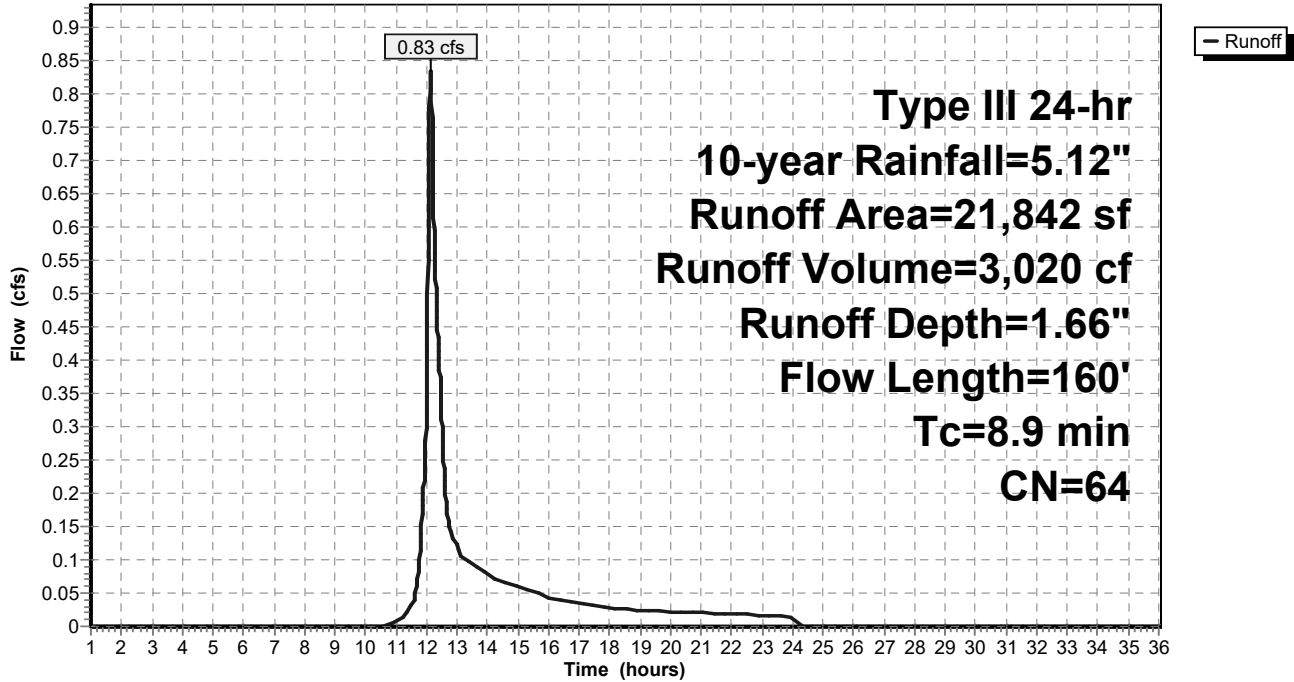

# Hydraflow 10-Yr Calcs

Prepared by Weston & Sampson

HydroCAD® 10.10-6a s/n 00455 © 2020 HydroCAD Software Solutions LLC

Type III 24-hr 10-year Rainfall=5.12"

Printed 11/5/2021

Page 20

## Summary for Subcatchment CB-08: CB-08

Runoff = 1.53 cfs @ 12.08 hrs, Volume= 5,303 cf, Depth= 4.77"

Runoff by SCS TR-20 method, UH=SCS, Weighted-CN, Time Span= 1.00-36.00 hrs, dt= 0.01 hrs  
Type III 24-hr 10-year Rainfall=5.12"

	Area (sf)	CN	Description
*	11,827	98	Paved Impervious, HSG B
	1,313	98	Roofs, HSG B
	211	61	>75% Grass cover, Good, HSG B
	13,351	97	Weighted Average
	211		1.58% Pervious Area
	13,140		98.42% Impervious Area

Tc (min)	Length (feet)	Slope (ft/ft)	Velocity (ft/sec)	Capacity (cfs)	Description
6.0					Direct Entry,

## Subcatchment CB-08: CB-08

Hydrograph

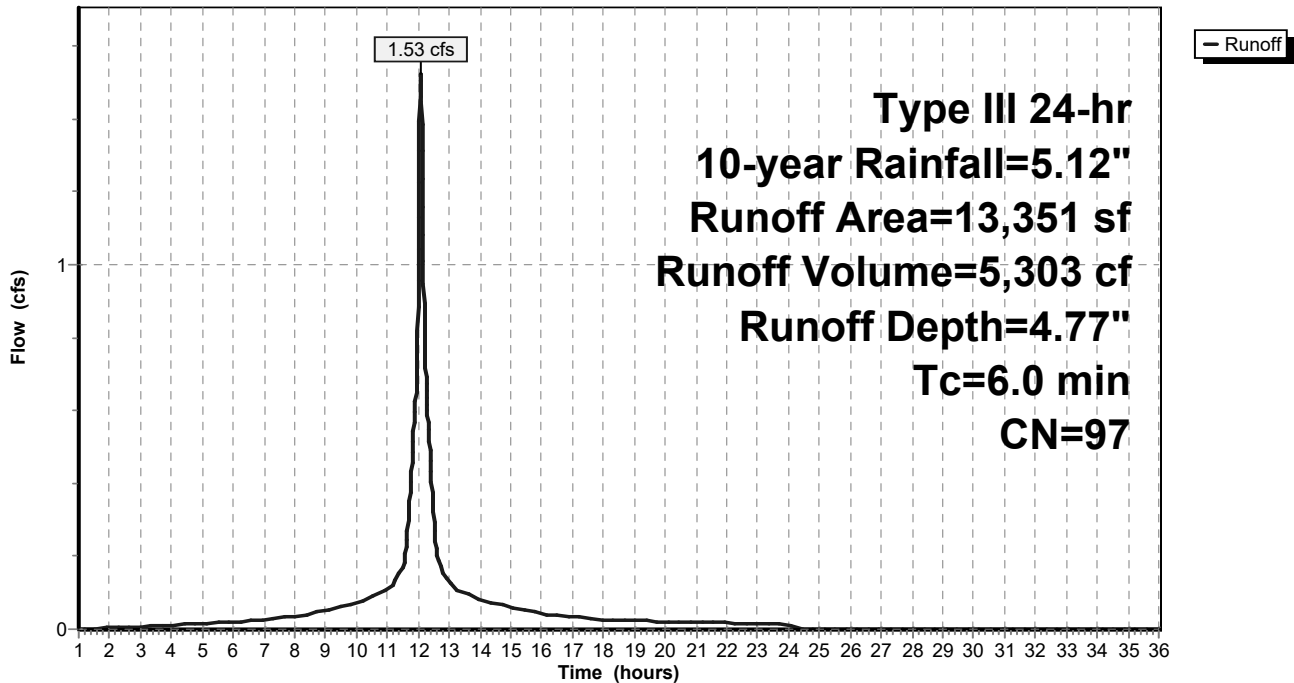

**Hydraflow 10-Yr Calcs**

Prepared by Weston & Sampson

HydroCAD® 10.10-6a s/n 00455 © 2020 HydroCAD Software Solutions LLC

Type III 24-hr 10-year Rainfall=5.12"

Printed 11/5/2021

Page 21

**Summary for Subcatchment CB-09: CB-09**

Runoff = 1.56 cfs @ 12.09 hrs, Volume= 4,874 cf, Depth= 3.48"  
 Routed to nonexistent node A

Runoff by SCS TR-20 method, UH=SCS, Weighted-CN, Time Span= 1.00-36.00 hrs, dt= 0.01 hrs  
 Type III 24-hr 10-year Rainfall=5.12"

Area (sf)	CN	Description
* 6,801	98	Paved Impervious, HSG B
4,041	98	Roofs, HSG B
5,752	61	>75% Grass cover, Good, HSG B
218	55	Woods, Good, HSG B
16,812	85	Weighted Average
5,970		35.51% Pervious Area
10,842		64.49% Impervious Area

Tc (min)	Length (feet)	Slope (ft/ft)	Velocity (ft/sec)	Capacity (cfs)	Description
6.0					Direct Entry,

**Subcatchment CB-09: CB-09**

Hydrograph

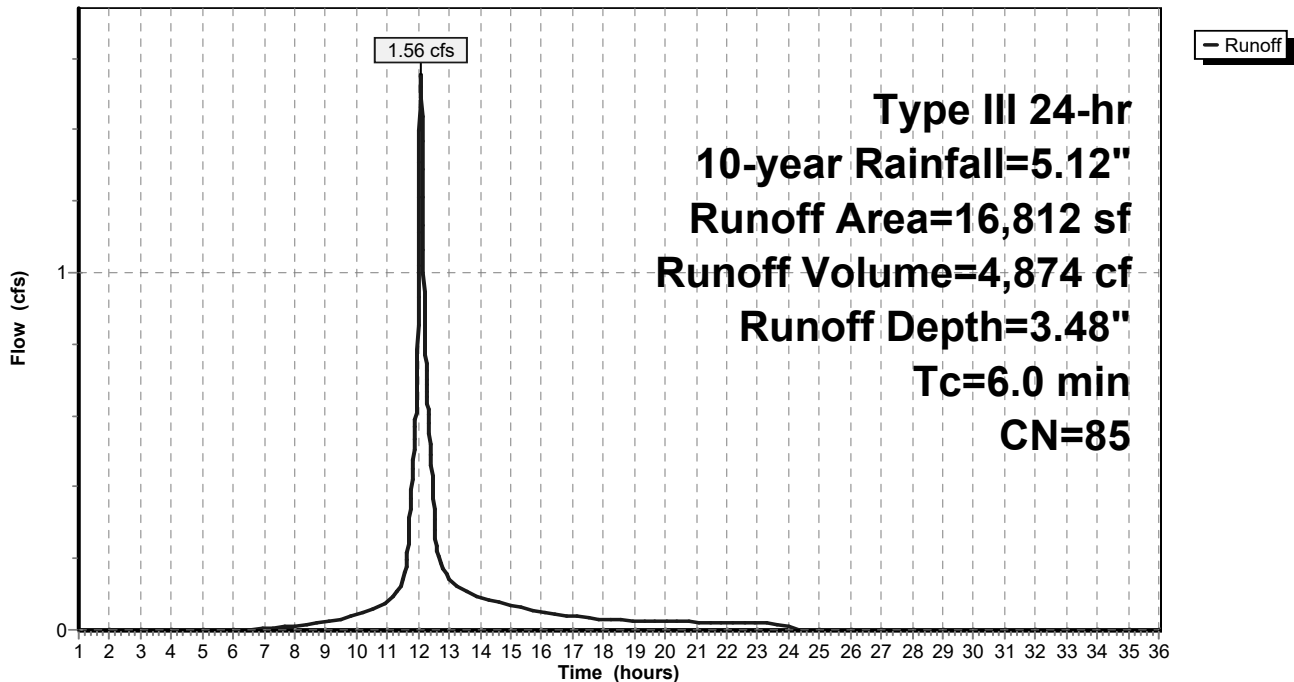

# Hydraflow 10-Yr Calcs

Prepared by Weston & Sampson

HydroCAD® 10.10-6a s/n 00455 © 2020 HydroCAD Software Solutions LLC

Type III 24-hr 10-year Rainfall=5.12"

Printed 11/5/2021

Page 22

## Summary for Subcatchment CB-10: CB-10

Runoff = 1.56 cfs @ 12.09 hrs, Volume= 4,874 cf, Depth= 3.48"  
 Routed to nonexistent node A

Runoff by SCS TR-20 method, UH=SCS, Weighted-CN, Time Span= 1.00-36.00 hrs, dt= 0.01 hrs  
 Type III 24-hr 10-year Rainfall=5.12"

	Area (sf)	CN	Description
*	6,801	98	Paved Impervious, HSG B
	4,041	98	Roofs, HSG B
	5,752	61	>75% Grass cover, Good, HSG B
	218	55	Woods, Good, HSG B
	16,812	85	Weighted Average
	5,970		35.51% Pervious Area
	10,842		64.49% Impervious Area

Tc (min)	Length (feet)	Slope (ft/ft)	Velocity (ft/sec)	Capacity (cfs)	Description
6.0					Direct Entry,

## Subcatchment CB-10: CB-10

Hydrograph

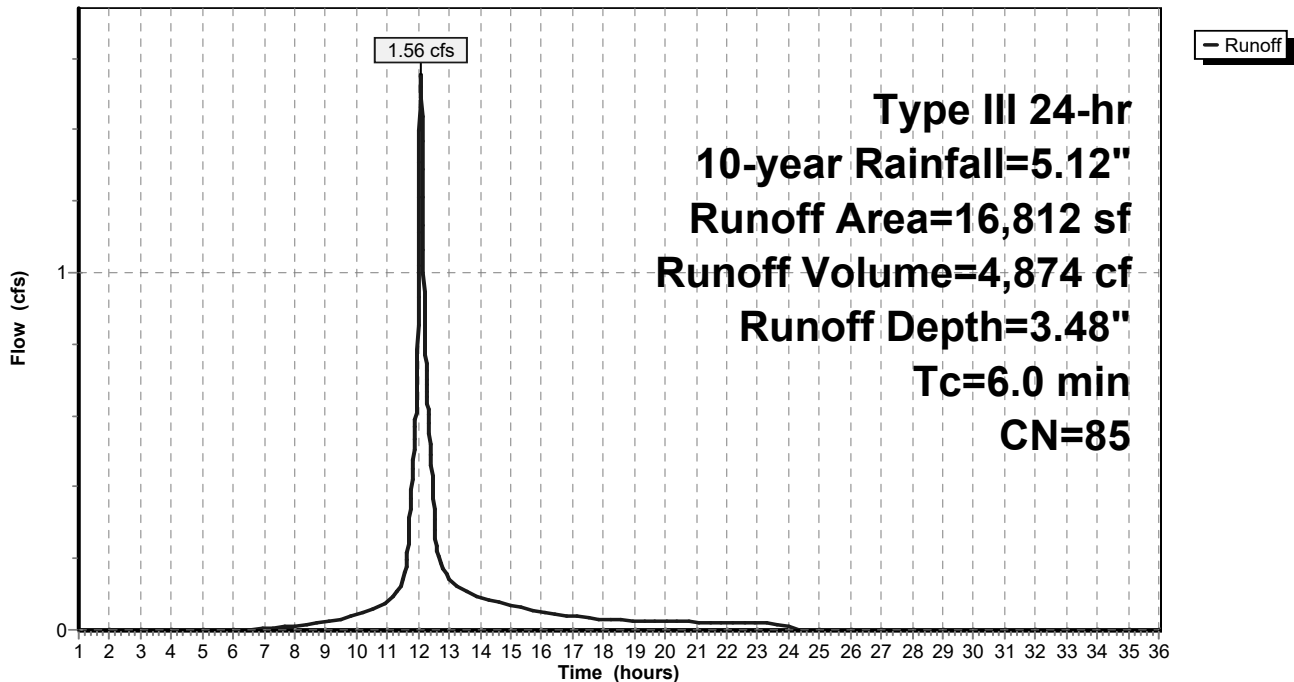

# Hydraflow 10-Yr Calcs

Prepared by Weston & Sampson

HydroCAD® 10.10-6a s/n 00455 © 2020 HydroCAD Software Solutions LLC

Type III 24-hr 10-year Rainfall=5.12"

Printed 11/5/2021

Page 23

## Summary for Subcatchment CB-11: CB-11

Runoff = 1.56 cfs @ 12.09 hrs, Volume= 4,874 cf, Depth= 3.48"  
 Routed to nonexistent node A

Runoff by SCS TR-20 method, UH=SCS, Weighted-CN, Time Span= 1.00-36.00 hrs, dt= 0.01 hrs  
 Type III 24-hr 10-year Rainfall=5.12"

	Area (sf)	CN	Description
*	6,801	98	Paved Impervious, HSG B
	4,041	98	Roofs, HSG B
	5,752	61	>75% Grass cover, Good, HSG B
	218	55	Woods, Good, HSG B
	16,812	85	Weighted Average
	5,970		35.51% Pervious Area
	10,842		64.49% Impervious Area

Tc (min)	Length (feet)	Slope (ft/ft)	Velocity (ft/sec)	Capacity (cfs)	Description
6.0					Direct Entry,

## Subcatchment CB-11: CB-11

Hydrograph

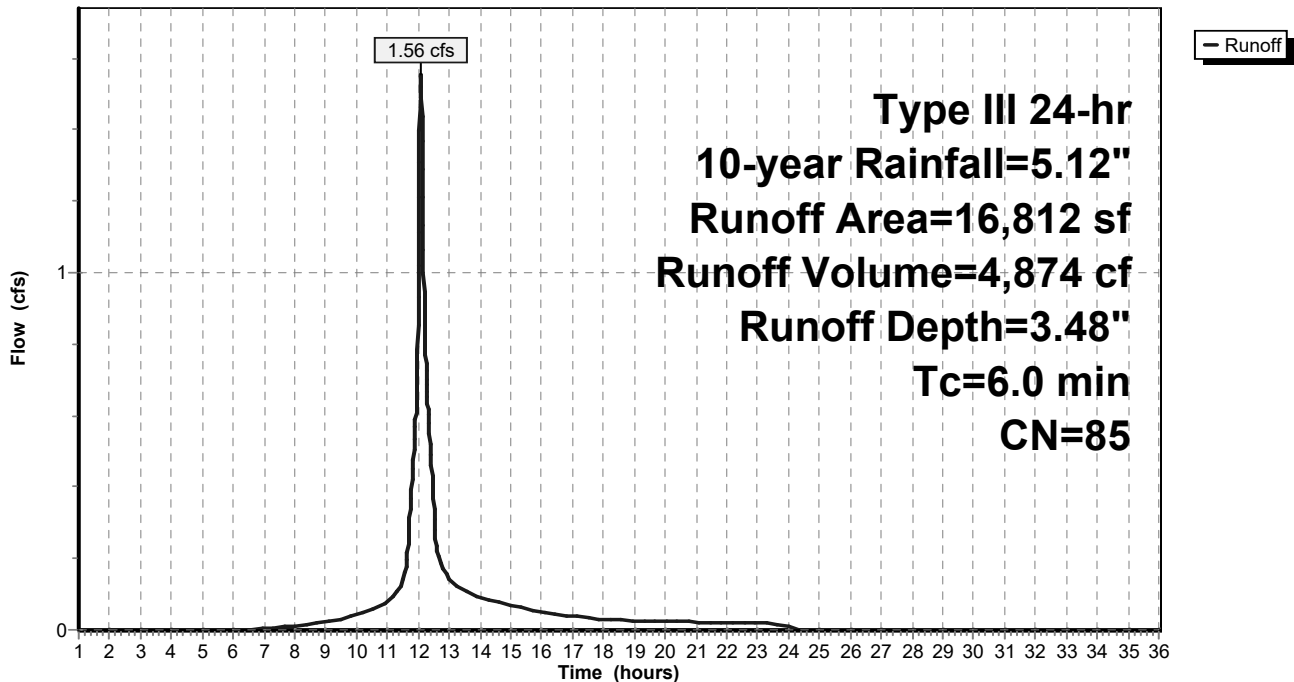

# Hydraflow 10-Yr Calcs

Prepared by Weston & Sampson

HydroCAD® 10.10-6a s/n 00455 © 2020 HydroCAD Software Solutions LLC

Type III 24-hr 10-year Rainfall=5.12"

Printed 11/5/2021

Page 24

## Summary for Subcatchment CB-12: CB-12

Runoff = 1.56 cfs @ 12.09 hrs, Volume= 4,874 cf, Depth= 3.48"  
 Routed to nonexistent node A

Runoff by SCS TR-20 method, UH=SCS, Weighted-CN, Time Span= 1.00-36.00 hrs, dt= 0.01 hrs  
 Type III 24-hr 10-year Rainfall=5.12"

	Area (sf)	CN	Description
*	6,801	98	Paved Impervious, HSG B
	4,041	98	Roofs, HSG B
	5,752	61	>75% Grass cover, Good, HSG B
	218	55	Woods, Good, HSG B
	16,812	85	Weighted Average
	5,970		35.51% Pervious Area
	10,842		64.49% Impervious Area

Tc (min)	Length (feet)	Slope (ft/ft)	Velocity (ft/sec)	Capacity (cfs)	Description
6.0					Direct Entry,

## Subcatchment CB-12: CB-12

Hydrograph

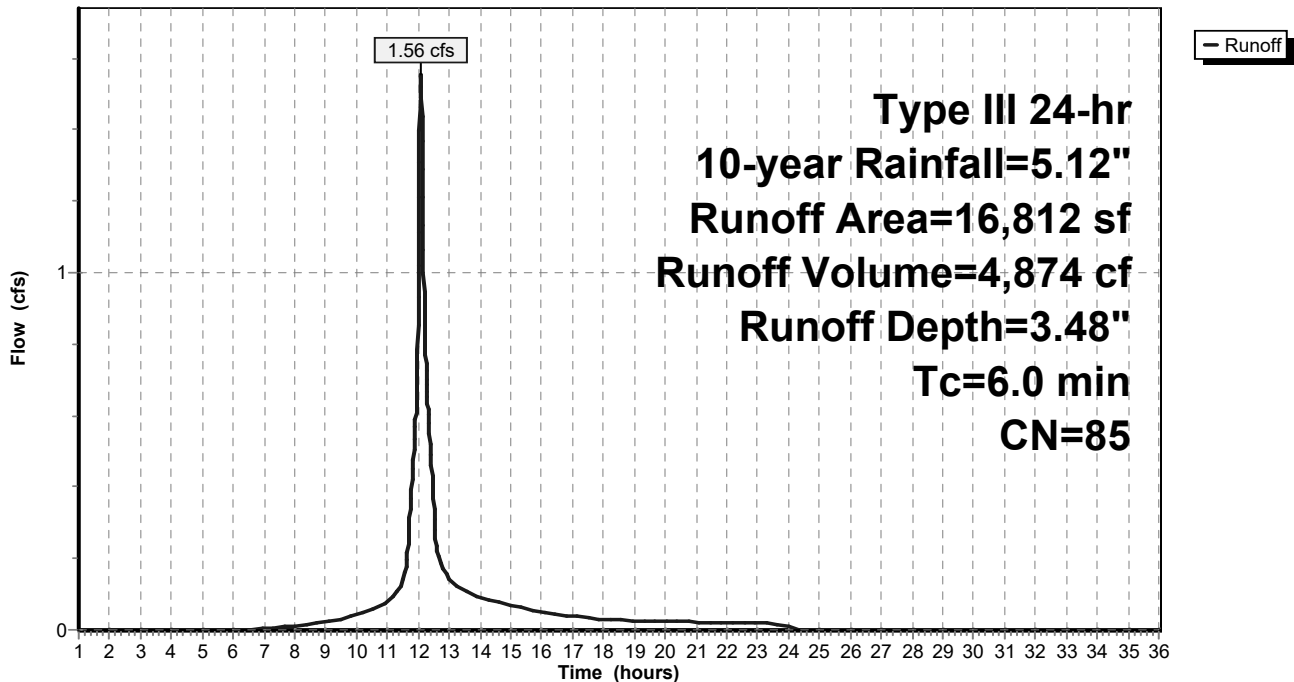



# Hydraflow 10-Yr Calcs

Prepared by Weston & Sampson

HydroCAD® 10.10-6a s/n 00455 © 2020 HydroCAD Software Solutions LLC

Type III 24-hr 10-year Rainfall=5.12"

Printed 11/5/2021

Page 25

## Summary for Subcatchment DMH-02: DMH-02

Runoff = 0.19 cfs @ 12.08 hrs, Volume= 672 cf, Depth> 4.88"  
Routed to nonexistent node A

Runoff by SCS TR-20 method, UH=SCS, Weighted-CN, Time Span= 1.00-36.00 hrs, dt= 0.01 hrs  
Type III 24-hr 10-year Rainfall=5.12"

Area (sf)	CN	Description
1,652	98	Roofs, HSG B
1,652		100.00% Impervious Area

Tc (min)	Length (feet)	Slope (ft/ft)	Velocity (ft/sec)	Capacity (cfs)	Description
6.0					Direct Entry,

## Subcatchment DMH-02: DMH-02

Hydrograph

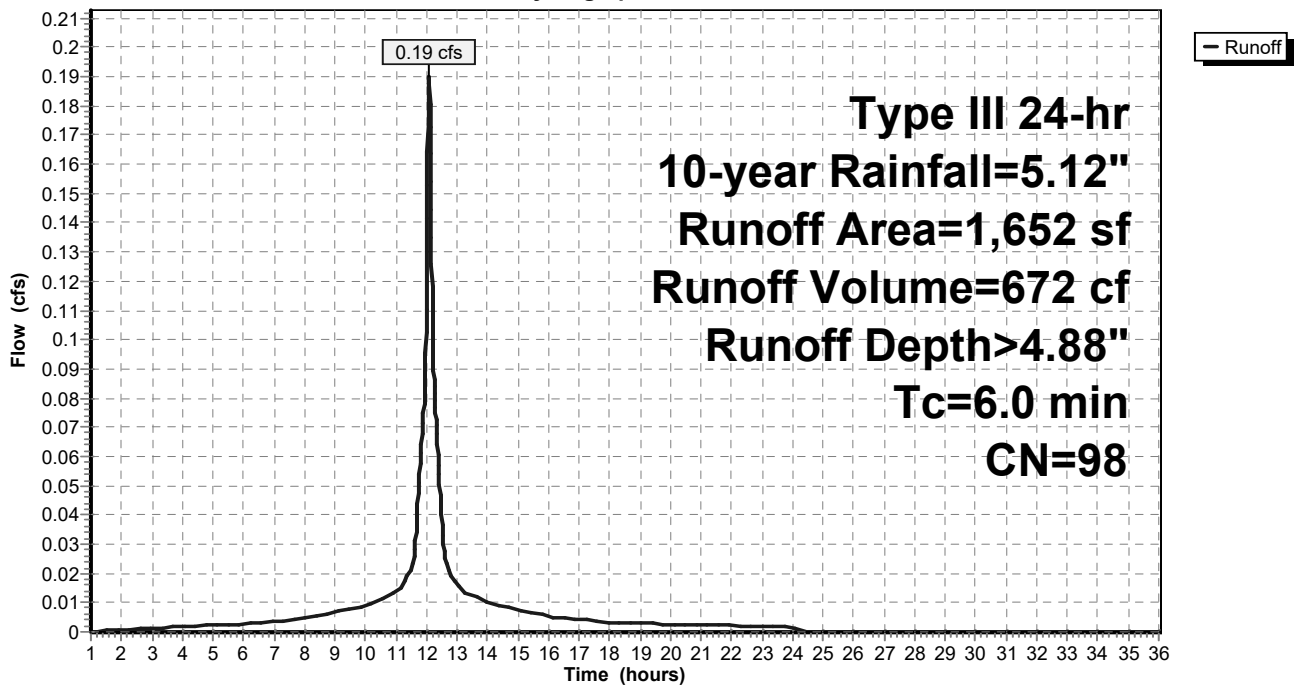

# Hydraflow 10-Yr Calcs

Prepared by Weston & Sampson

HydroCAD® 10.10-6a s/n 00455 © 2020 HydroCAD Software Solutions LLC

Type III 24-hr 10-year Rainfall=5.12"

Printed 11/5/2021

Page 26

## Summary for Subcatchment DMH-08: DMH-08

Runoff = 1.10 cfs @ 12.08 hrs, Volume= 3,908 cf, Depth> 4.88"  
Routed to nonexistent node A

Runoff by SCS TR-20 method, UH=SCS, Weighted-CN, Time Span= 1.00-36.00 hrs, dt= 0.01 hrs  
Type III 24-hr 10-year Rainfall=5.12"

Area (sf)	CN	Description
1,275	98	Roofs, HSG A
8,330	98	Roofs, HSG B
9,605	98	Weighted Average
9,605		100.00% Impervious Area

Tc (min)	Length (feet)	Slope (ft/ft)	Velocity (ft/sec)	Capacity (cfs)	Description
6.0					Direct Entry,

## Subcatchment DMH-08: DMH-08

Hydrograph

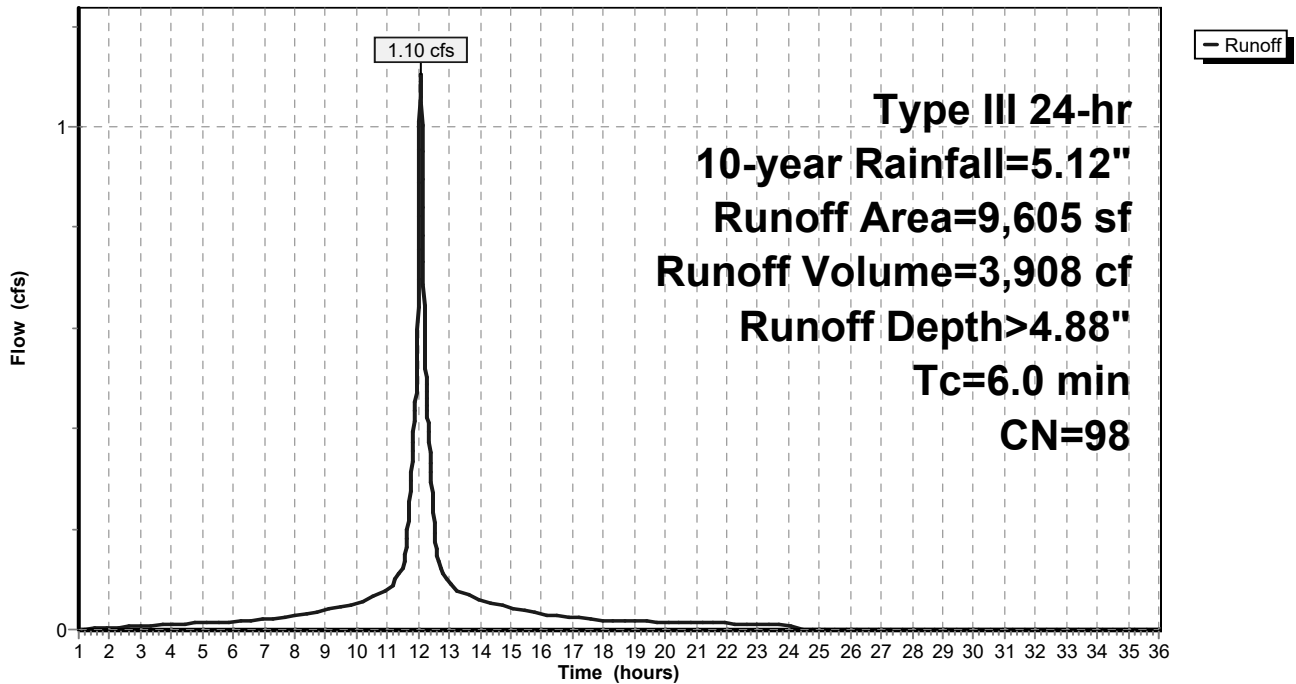

# Hydraflow 10-Yr Calcs

Prepared by Weston & Sampson

HydroCAD® 10.10-6a s/n 00455 © 2020 HydroCAD Software Solutions LLC

Type III 24-hr 10-year Rainfall=5.12"

Printed 11/5/2021

Page 27

## Summary for Subcatchment DMH-13: DMH-13

Runoff = 6.07 cfs @ 12.09 hrs, Volume= 18,941 cf, Depth= 3.38"  
 Routed to nonexistent node A

Runoff by SCS TR-20 method, UH=SCS, Weighted-CN, Time Span= 1.00-36.00 hrs, dt= 0.01 hrs  
 Type III 24-hr 10-year Rainfall=5.12"

	Area (sf)	CN	Description
*	25,873	98	Paved Impervious, HSG B
	16,163	98	Roofs, HSG B
	24,333	61	>75% Grass cover, Good, HSG B
	869	55	Woods, Good, HSG B
	67,238	84	Weighted Average
	25,202		37.48% Pervious Area
	42,036		62.52% Impervious Area

Tc (min)	Length (feet)	Slope (ft/ft)	Velocity (ft/sec)	Capacity (cfs)	Description
6.0					Direct Entry,

## Subcatchment DMH-13: DMH-13

Hydrograph

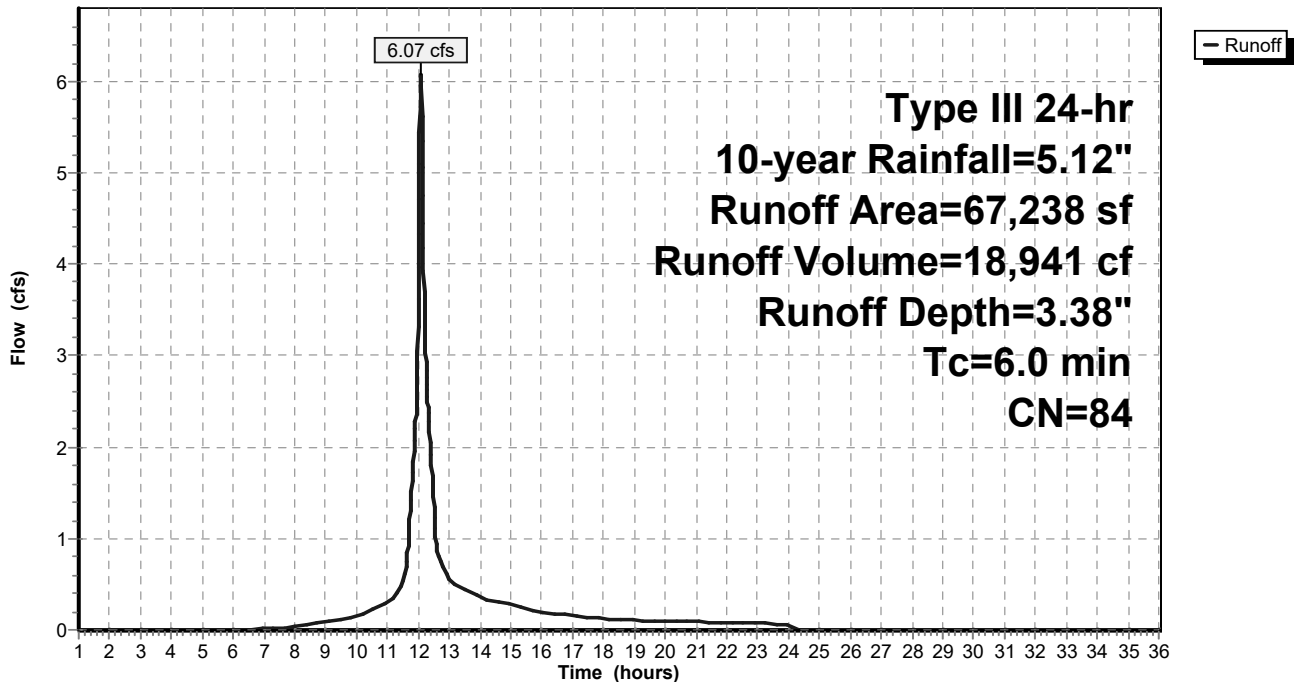

# Hydraflow 10-Yr Calcs

Prepared by Weston & Sampson

HydroCAD® 10.10-6a s/n 00455 © 2020 HydroCAD Software Solutions LLC

Type III 24-hr 10-year Rainfall=5.12"

Printed 11/5/2021

Page 28

## Summary for Subcatchment ECB-01: ECB-01

Runoff = 0.18 cfs @ 12.09 hrs, Volume= 588 cf, Depth= 1.81"

Runoff by SCS TR-20 method, UH=SCS, Weighted-CN, Time Span= 1.00-36.00 hrs, dt= 0.01 hrs  
Type III 24-hr 10-year Rainfall=5.12"

	Area (sf)	CN	Description
*	1,816	98	Paved Impervious, HSG A
	2,081	39	>75% Grass cover, Good, HSG A
	3,897	66	Weighted Average
	2,081		53.40% Pervious Area
	1,816		46.60% Impervious Area

Tc (min)	Length (feet)	Slope (ft/ft)	Velocity (ft/sec)	Capacity (cfs)	Description
6.0					Direct Entry,

## Subcatchment ECB-01: ECB-01

Hydrograph

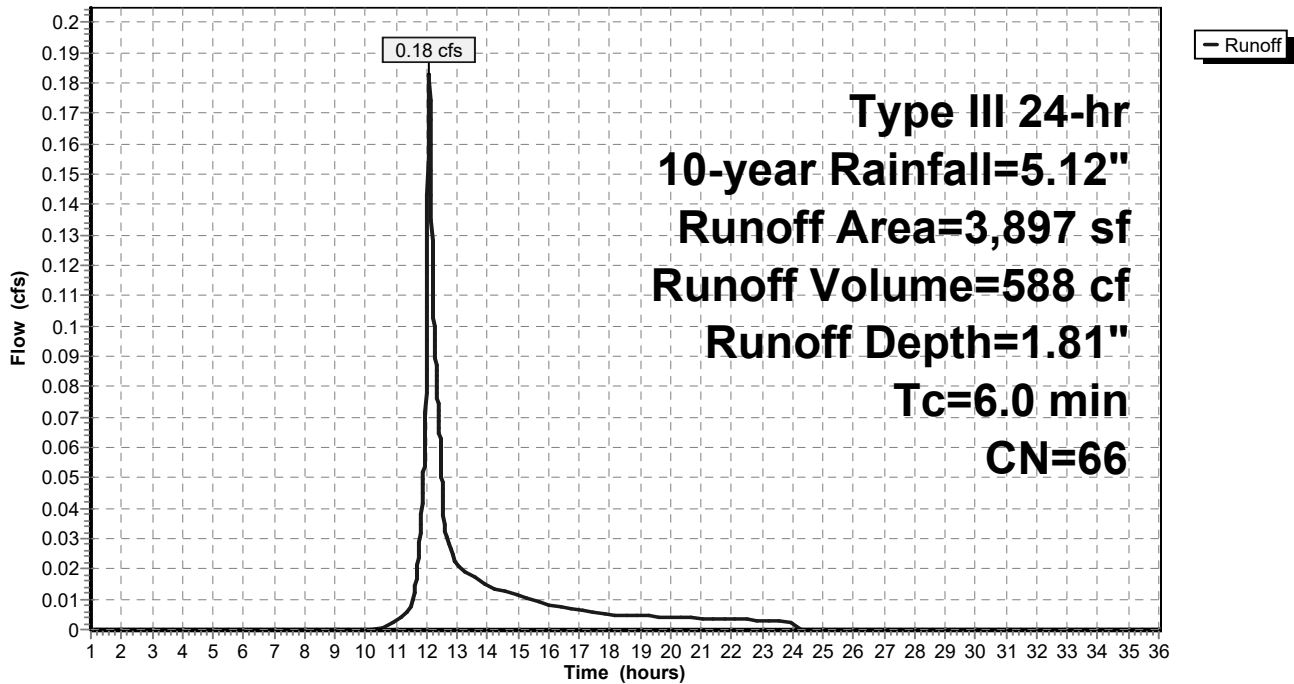

# Hydraflow 10-Yr Calcs

Prepared by Weston & Sampson

HydroCAD® 10.10-6a s/n 00455 © 2020 HydroCAD Software Solutions LLC

Type III 24-hr 10-year Rainfall=5.12"

Printed 11/5/2021

Page 29

## Summary for Subcatchment ECB-02: ECB-02

Runoff = 0.31 cfs @ 12.09 hrs, Volume= 971 cf, Depth= 3.58"

Runoff by SCS TR-20 method, UH=SCS, Weighted-CN, Time Span= 1.00-36.00 hrs, dt= 0.01 hrs  
Type III 24-hr 10-year Rainfall=5.12"

	Area (sf)	CN	Description
*	1,347	98	Paved Impervious, HSG A
*	1,096	98	Paved Impervious, HSG B
	463	39	>75% Grass cover, Good, HSG A
	350	61	>75% Grass cover, Good, HSG B
	3,256	86	Weighted Average
	813		24.97% Pervious Area
	2,443		75.03% Impervious Area

Tc (min)	Length (feet)	Slope (ft/ft)	Velocity (ft/sec)	Capacity (cfs)	Description
6.0					Direct Entry,

## Subcatchment ECB-02: ECB-02

Hydrograph

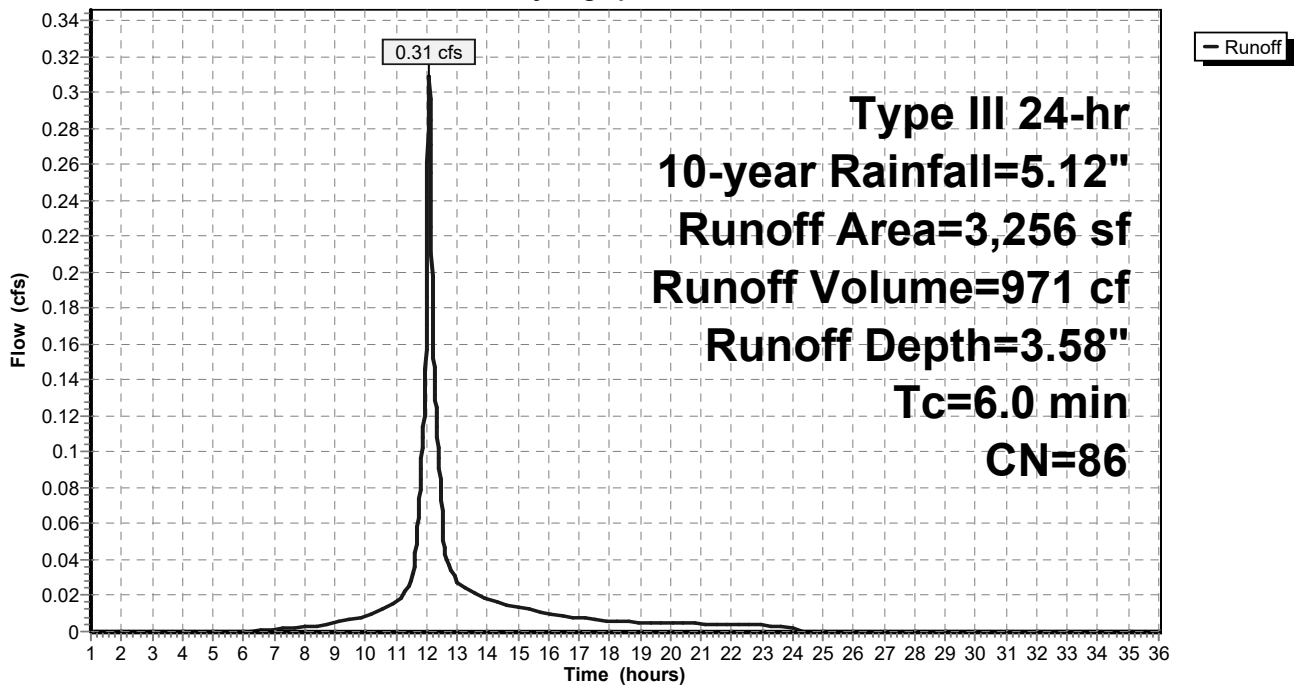

# Hydraflow 10-Yr Calcs

Prepared by Weston & Sampson

HydroCAD® 10.10-6a s/n 00455 © 2020 HydroCAD Software Solutions LLC

Type III 24-hr 10-year Rainfall=5.12"

Printed 11/5/2021

Page 30

## Summary for Subcatchment ECB-03: ECB-03

Runoff = 0.18 cfs @ 12.09 hrs, Volume= 588 cf, Depth= 1.81"

Runoff by SCS TR-20 method, UH=SCS, Weighted-CN, Time Span= 1.00-36.00 hrs, dt= 0.01 hrs  
Type III 24-hr 10-year Rainfall=5.12"

	Area (sf)	CN	Description
*	1,816	98	Paved Impervious, HSG A
	2,081	39	>75% Grass cover, Good, HSG A
	3,897	66	Weighted Average
	2,081		53.40% Pervious Area
	1,816		46.60% Impervious Area

Tc (min)	Length (feet)	Slope (ft/ft)	Velocity (ft/sec)	Capacity (cfs)	Description
6.0					Direct Entry,

## Subcatchment ECB-03: ECB-03

Hydrograph

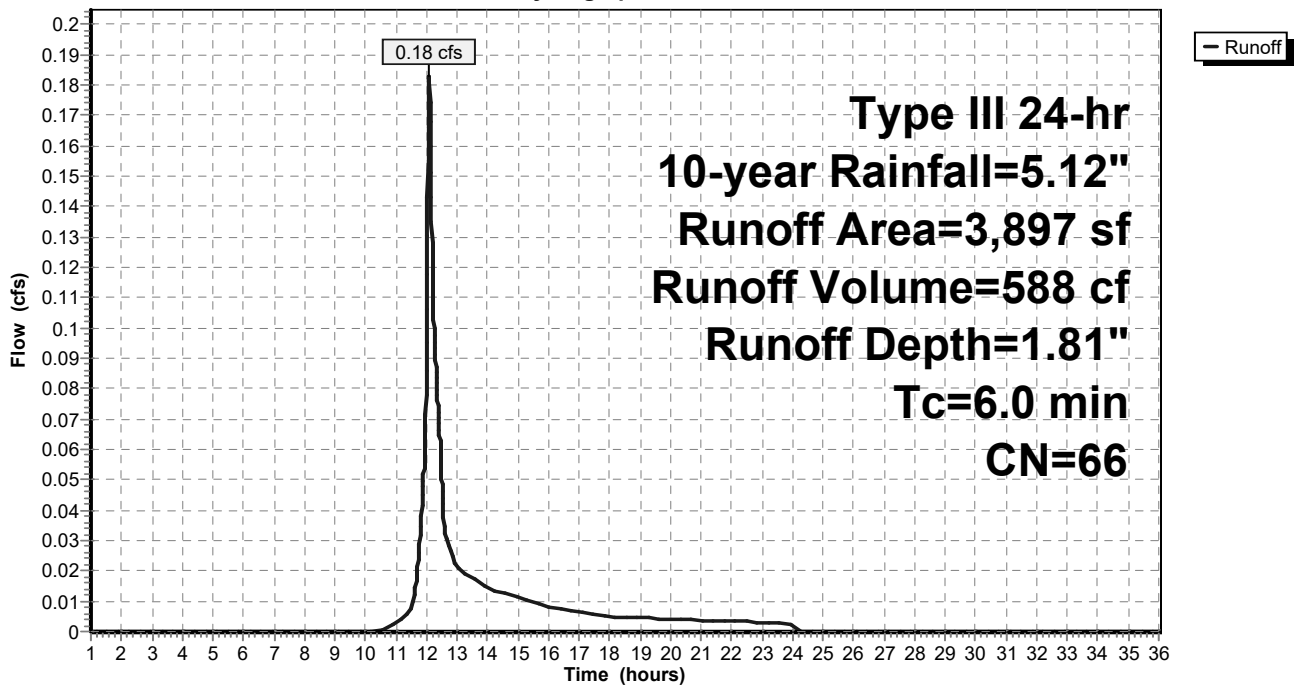

# Hydraflow 10-Yr Calcs

Prepared by Weston & Sampson

HydroCAD® 10.10-6a s/n 00455 © 2020 HydroCAD Software Solutions LLC

Type III 24-hr 10-year Rainfall=5.12"

Printed 11/5/2021

Page 31

## Summary for Subcatchment ECB-04: ECB-04

Runoff = 0.27 cfs @ 12.09 hrs, Volume= 861 cf, Depth= 2.13"

Runoff by SCS TR-20 method, UH=SCS, Weighted-CN, Time Span= 1.00-36.00 hrs, dt= 0.01 hrs  
Type III 24-hr 10-year Rainfall=5.12"

	Area (sf)	CN	Description
*	2,560	98	Paved Impervious, HSG A
	2,300	39	>75% Grass cover, Good, HSG A
	4,860	70	Weighted Average
	2,300		47.33% Pervious Area
	2,560		52.67% Impervious Area

Tc (min)	Length (feet)	Slope (ft/ft)	Velocity (ft/sec)	Capacity (cfs)	Description
6.0					Direct Entry,

## Subcatchment ECB-04: ECB-04

Hydrograph

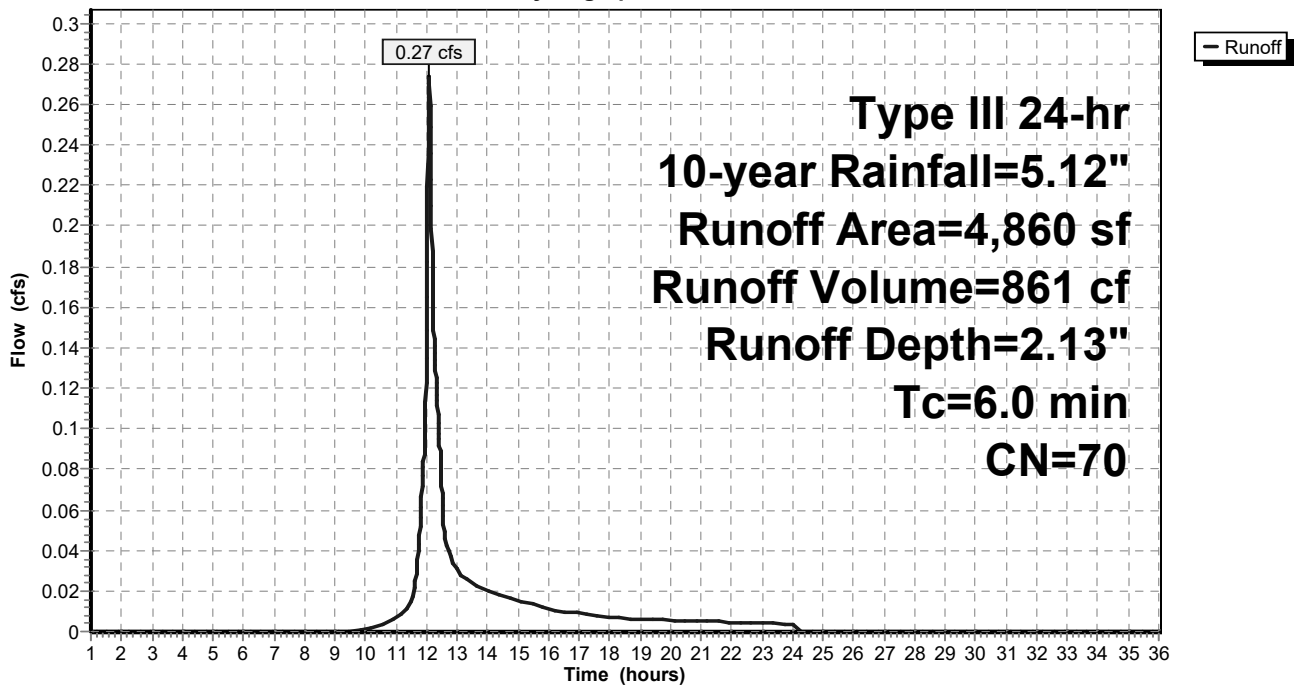

**Hydraflow 10-Yr Calcs**

Prepared by Weston & Sampson

HydroCAD® 10.10-6a s/n 00455 © 2020 HydroCAD Software Solutions LLC

Type III 24-hr 10-year Rainfall=5.12"

Printed 11/5/2021

Page 32

**Summary for Subcatchment ECB-05: ECB-05**

Runoff = 0.00 cfs @ 14.99 hrs, Volume= 85 cf, Depth= 0.10"

Runoff by SCS TR-20 method, UH=SCS, Weighted-CN, Time Span= 1.00-36.00 hrs, dt= 0.01 hrs  
Type III 24-hr 10-year Rainfall=5.12"

Area (sf)	CN	Description
5,906	39	>75% Grass cover, Good, HSG A
4,418	30	Woods, Good, HSG A
10,324	35	Weighted Average
10,324		100.00% Pervious Area

Tc (min)	Length (feet)	Slope (ft/ft)	Velocity (ft/sec)	Capacity (cfs)	Description
6.4	50	0.1000	0.13		<b>Sheet Flow,</b> Woods: Light underbrush n= 0.400 P2= 3.30"
0.7	52	0.0570	1.19		<b>Shallow Concentrated Flow,</b> Woodland Kv= 5.0 fps
0.3	34	0.0580	1.69		<b>Shallow Concentrated Flow,</b> Short Grass Pasture Kv= 7.0 fps
7.4	136	Total			

**Subcatchment ECB-05: ECB-05**

Hydrograph



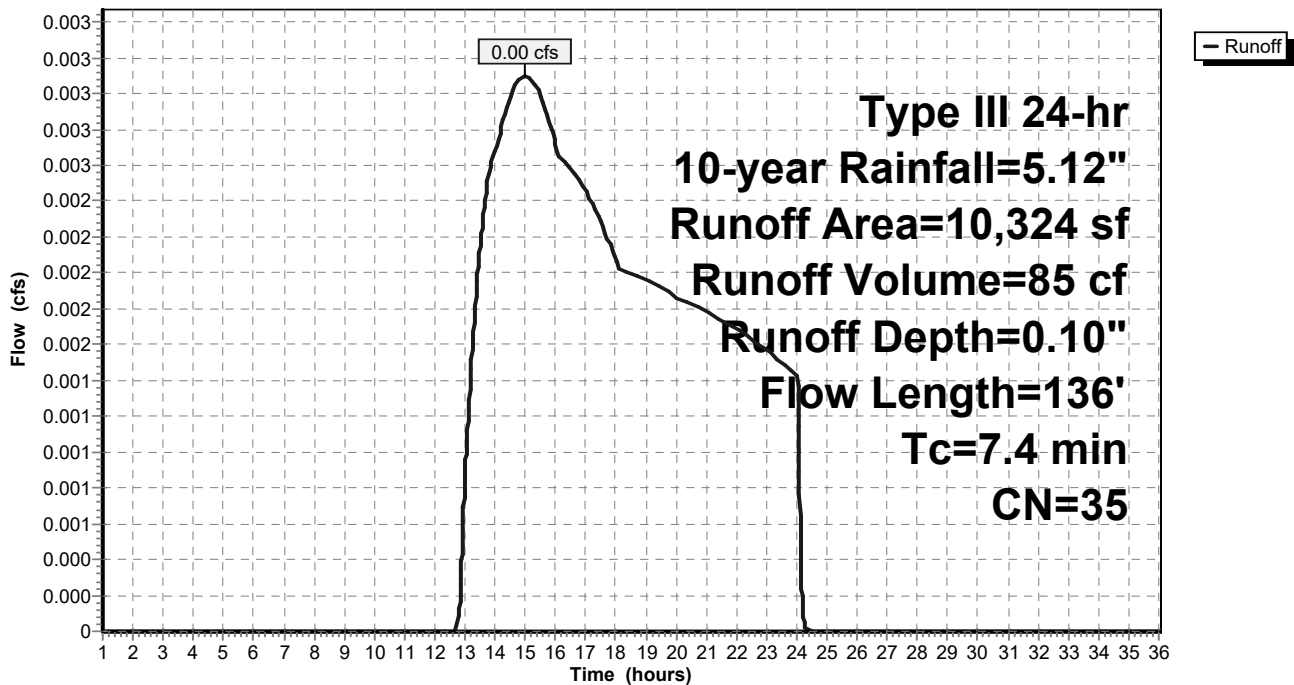

# Hydraflow 10-Yr Calcs

Prepared by Weston & Sampson

HydroCAD® 10.10-6a s/n 00455 © 2020 HydroCAD Software Solutions LLC

Type III 24-hr 10-year Rainfall=5.12"

Printed 11/5/2021

Page 33

## Summary for Subcatchment ECB-06: ECB-06

Runoff = 2.31 cfs @ 12.10 hrs, Volume= 7,605 cf, Depth= 3.48"

Runoff by SCS TR-20 method, UH=SCS, Weighted-CN, Time Span= 1.00-36.00 hrs, dt= 0.01 hrs  
Type III 24-hr 10-year Rainfall=5.12"

Area (sf)	CN	Description
* 6,165	98	Paved Impervious, HSG A
* 1,528	98	Paved Impervious, HSG B
3,894	98	Roofs, HSG A
8,917	98	Roofs, HSG B
4,360	39	>75% Grass cover, Good, HSG A
1,368	30	Woods, Good, HSG A
26,232	85	Weighted Average
5,728		21.84% Pervious Area
20,504		78.16% Impervious Area

Tc (min)	Length (feet)	Slope (ft/ft)	Velocity (ft/sec)	Capacity (cfs)	Description
6.4	50	0.1000	0.13		<b>Sheet Flow,</b> Woods: Light underbrush n= 0.400 P2= 3.30"
0.7	52	0.0570	1.19		<b>Shallow Concentrated Flow,</b> Woodland Kv= 5.0 fps
0.3	34	0.0580	1.69		<b>Shallow Concentrated Flow,</b> Short Grass Pasture Kv= 7.0 fps
7.4	136	Total			

**Hydraflow 10-Yr Calcs**

Prepared by Weston & Sampson

HydroCAD® 10.10-6a s/n 00455 © 2020 HydroCAD Software Solutions LLC

Type III 24-hr 10-year Rainfall=5.12"

Printed 11/5/2021

Page 34

**Subcatchment ECB-06: ECB-06**

Hydrograph

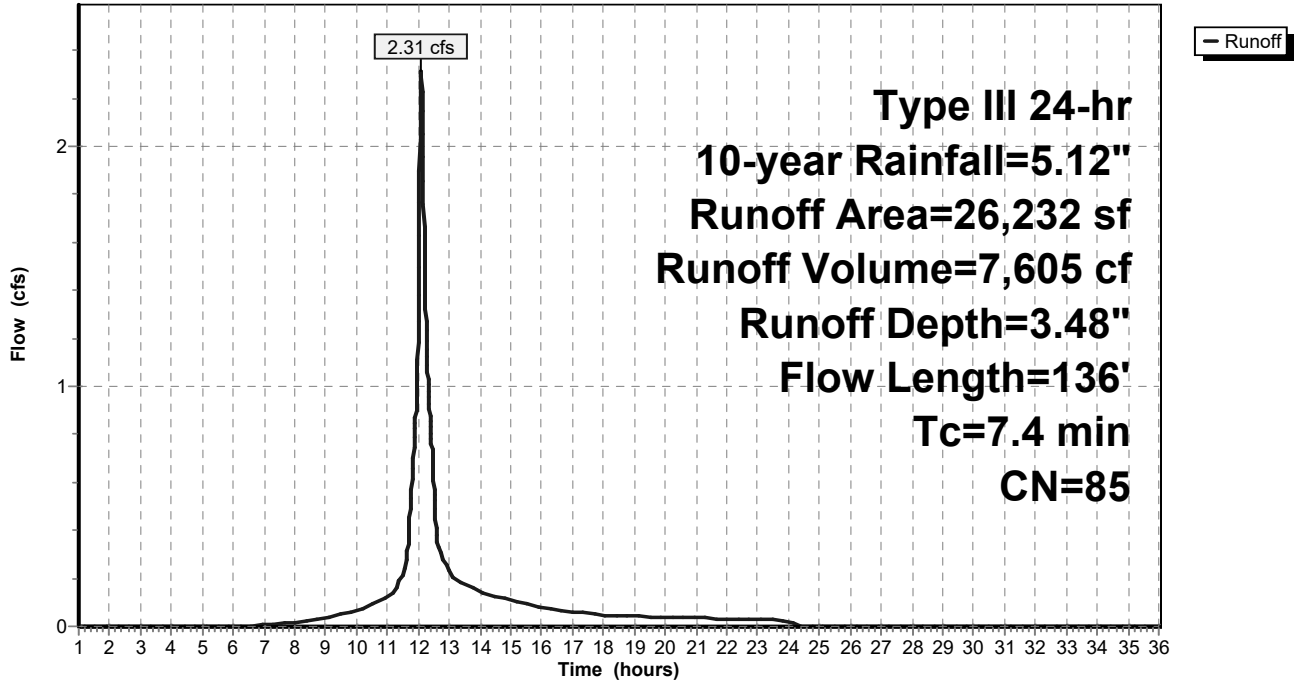

# Hydraflow 10-Yr Calcs

Prepared by Weston & Sampson

HydroCAD® 10.10-6a s/n 00455 © 2020 HydroCAD Software Solutions LLC

Type III 24-hr 10-year Rainfall=5.12"

Printed 11/5/2021

Page 35

## Summary for Subcatchment ECB-07: ECB-07

Runoff = 0.65 cfs @ 12.10 hrs, Volume= 2,222 cf, Depth= 1.37"

Runoff by SCS TR-20 method, UH=SCS, Weighted-CN, Time Span= 1.00-36.00 hrs, dt= 0.01 hrs  
Type III 24-hr 10-year Rainfall=5.12"

	Area (sf)	CN	Description
*	3,420	98	Paved Impervious, HSG B
	523	39	>75% Grass cover, Good, HSG A
	6,591	61	>75% Grass cover, Good, HSG B
	3,334	30	Woods, Good, HSG A
	5,567	55	Woods, Good, HSG B
	19,435	60	Weighted Average
	16,015		82.40% Pervious Area
	3,420		17.60% Impervious Area

Tc (min)	Length (feet)	Slope (ft/ft)	Velocity (ft/sec)	Capacity (cfs)	Description
6.0					Direct Entry,

## Subcatchment ECB-07: ECB-07

Hydrograph

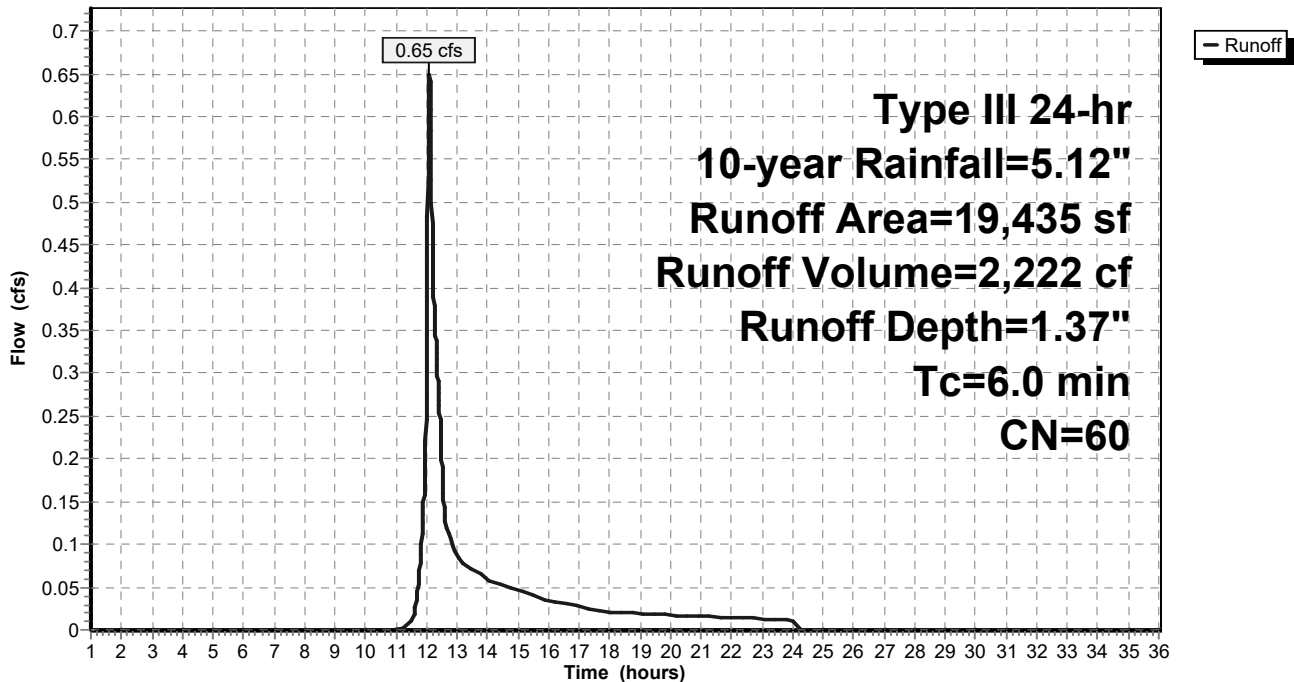

# Hydraflow 10-Yr Calcs

Prepared by Weston & Sampson

HydroCAD® 10.10-6a s/n 00455 © 2020 HydroCAD Software Solutions LLC

Type III 24-hr 10-year Rainfall=5.12"

Printed 11/5/2021

Page 36

## Summary for Subcatchment ECB-08: ECB-08

Runoff = 1.04 cfs @ 12.20 hrs, Volume= 4,613 cf, Depth= 1.24"  
 Routed to nonexistent node A

Runoff by SCS TR-20 method, UH=SCS, Weighted-CN, Time Span= 1.00-36.00 hrs, dt= 0.01 hrs  
 Type III 24-hr 10-year Rainfall=5.12"

Area (sf)	CN	Description
* 3,625	98	Paved Impervious, HSG A
* 8,132	98	Paved Impervious, HSG B
13,635	30	Woods, Good, HSG A
13,102	55	Woods, Good, HSG B
2,357	39	>75% Grass cover, Good, HSG A
3,960	61	>75% Grass cover, Good, HSG B
44,811	58	Weighted Average
33,054		73.76% Pervious Area
11,757		26.24% Impervious Area

Tc (min)	Length (feet)	Slope (ft/ft)	Velocity (ft/sec)	Capacity (cfs)	Description
7.8	50	0.0600	0.11		<b>Sheet Flow,</b> Woods: Light underbrush n= 0.400 P2= 3.30"
2.5	120	0.0250	0.79		<b>Shallow Concentrated Flow,</b> Woodland Kv= 5.0 fps
2.4	293	0.0100	2.03		<b>Shallow Concentrated Flow,</b> Paved Kv= 20.3 fps
12.7	463	Total			

**Hydraflow 10-Yr Calcs**

Prepared by Weston & Sampson

HydroCAD® 10.10-6a s/n 00455 © 2020 HydroCAD Software Solutions LLC

Type III 24-hr 10-year Rainfall=5.12"

Printed 11/5/2021

Page 37

**Subcatchment ECB-08: ECB-08**

Hydrograph

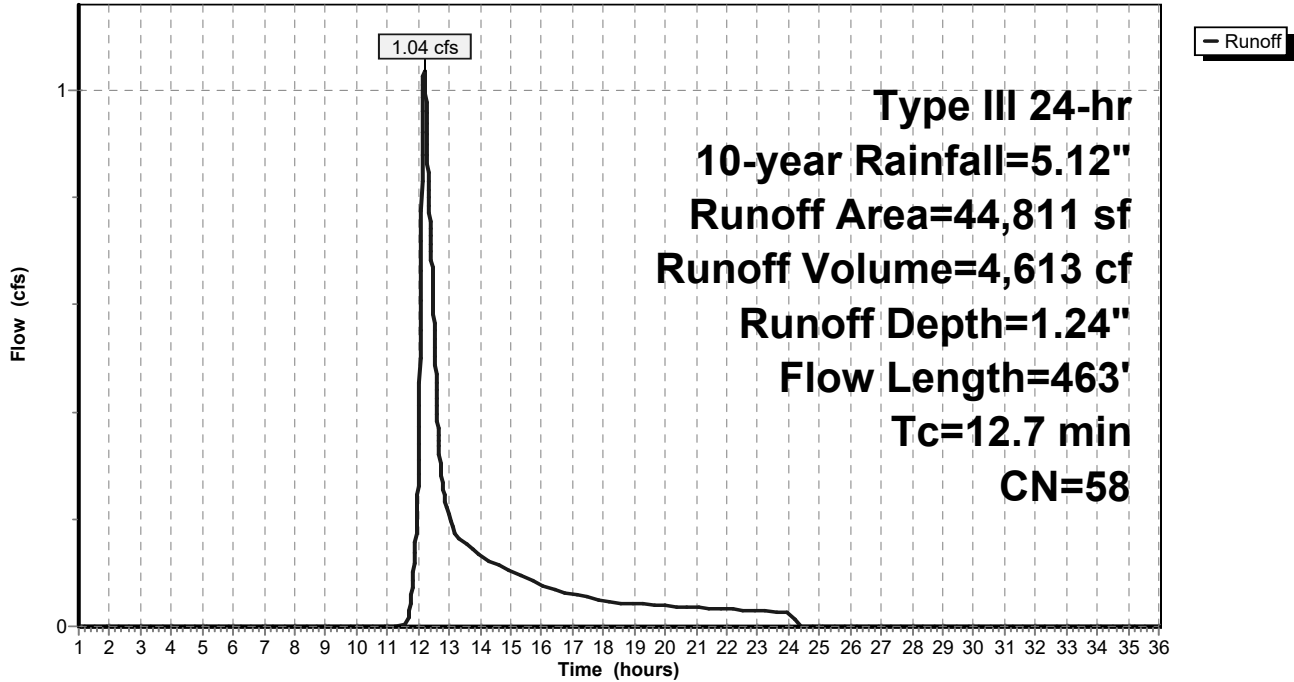

# Hydraflow 10-Yr Calcs

Prepared by Weston & Sampson

HydroCAD® 10.10-6a s/n 00455 © 2020 HydroCAD Software Solutions LLC

Type III 24-hr 10-year Rainfall=5.12"

Printed 11/5/2021

Page 38

## Summary for Pond BR-1: BR-1

Inflow Area = 16,500 sf, 77.45% Impervious, Inflow Depth = 3.58" for 10-year event  
 Inflow = 1.57 cfs @ 12.09 hrs, Volume= 4,921 cf  
 Outflow = 1.56 cfs @ 12.09 hrs, Volume= 4,207 cf, Atten= 0%, Lag= 0.4 min  
 Primary = 1.56 cfs @ 12.09 hrs, Volume= 4,207 cf  
 Routed to Pond IS-1 : IS-1  
 Secondary = 0.00 cfs @ 1.00 hrs, Volume= 0 cf  
 Routed to Pond IS-1 : IS-1

Routing by Dyn-Stor-Ind method, Time Span= 1.00-36.00 hrs, dt= 0.01 hrs  
 Peak Elev= 100.93' @ 12.09 hrs Surf.Area= 300 sf Storage= 760 cf

Plug-Flow detention time= 95.2 min calculated for 4,206 cf (85% of inflow)  
 Center-of-Mass det. time= 32.7 min ( 836.2 - 803.5 )

Volume	Invert	Avail.Storage	Storage Description	
#1	97.24'	1,148 cf	<b>Custom Stage Data (Prismatic)</b> Listed below (Recalc)	
Elevation (feet)	Surf.Area (sq-ft)	Voids (%)	Inc.Store (cubic-feet)	Cum.Store (cubic-feet)
97.24	641	0.0	0	0
97.25	641	40.0	3	3
97.74	641	40.0	126	128
97.75	641	30.0	2	130
100.24	641	30.0	479	609
100.25	641	40.0	3	612
100.49	641	40.0	62	673
100.50	88	100.0	4	677
101.00	335	100.0	106	782
101.75	641	100.0	366	1,148

Device	Routing	Invert	Outlet Devices
#1	Device 2	100.75'	<b>24.0" Horiz. Orifice/Grate</b> C= 0.600 Limited to weir flow at low heads
#2	Primary	92.75'	<b>12.0" Round Culvert</b> L= 23.9' CPP, projecting, no headwall, Ke= 0.900 Inlet / Outlet Invert= 92.75' / 92.27' S= 0.0201 '/' Cc= 0.900 n= 0.130, Flow Area= 0.79 sf
#3	Secondary	101.25'	<b>15.0' long x 10.0' breadth Broad-Crested Rectangular Weir</b> Head (feet) 0.20 0.40 0.60 0.80 1.00 1.20 1.40 1.60 Coef. (English) 2.49 2.56 2.70 2.69 2.68 2.69 2.67 2.64

**Primary OutFlow** Max=1.56 cfs @ 12.09 hrs HW=100.93' TW=92.42' (Dynamic Tailwater)  
 ↑ **2=Culvert** (Passes 1.56 cfs of 1.99 cfs potential flow)  
 ↑ **1=Orifice/Grate** (Weir Controls 1.56 cfs @ 1.38 fps)

**Secondary OutFlow** Max=0.00 cfs @ 1.00 hrs HW=97.24' TW=90.50' (Dynamic Tailwater)  
 ↑ **3=Broad-Crested Rectangular Weir** ( Controls 0.00 cfs)

# Hydraflow 10-Yr Calcs

Prepared by Weston & Sampson

HydroCAD® 10.10-6a s/n 00455 © 2020 HydroCAD Software Solutions LLC

Type III 24-hr 10-year Rainfall=5.12"

Printed 11/5/2021

Page 39

## Pond BR-1: BR-1

Hydrograph

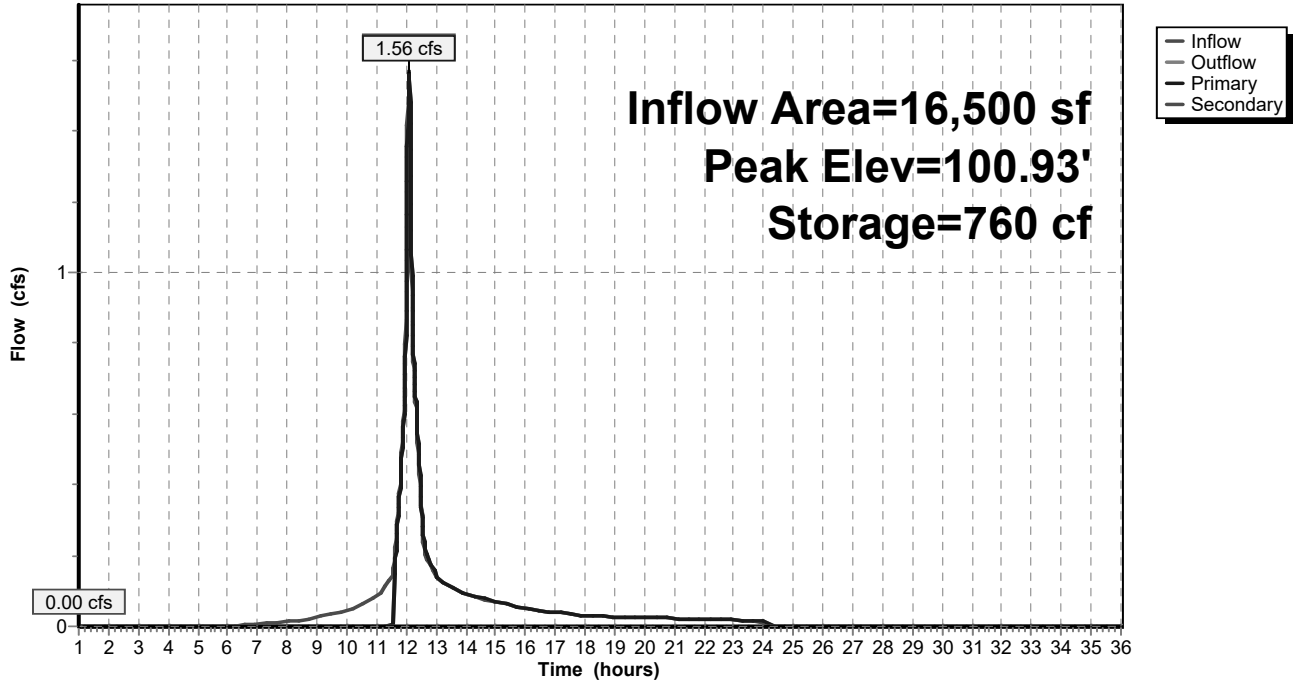

# Hydraflow 10-Yr Calcs

Prepared by Weston & Sampson

HydroCAD® 10.10-6a s/n 00455 © 2020 HydroCAD Software Solutions LLC

Type III 24-hr 10-year Rainfall=5.12"

Printed 11/5/2021

Page 40

## Summary for Pond DS-1: DS-1

Inflow Area = 35,193 sf, 61.85% Impervious, Inflow Depth = 2.72" for 10-year event  
 Inflow = 2.34 cfs @ 12.13 hrs, Volume= 7,988 cf  
 Outflow = 2.32 cfs @ 12.14 hrs, Volume= 7,987 cf, Atten= 1%, Lag= 0.7 min  
 Primary = 2.32 cfs @ 12.14 hrs, Volume= 7,987 cf  
 Routed to nonexistent node A

Routing by Dyn-Stor-Ind method, Time Span= 1.00-36.00 hrs, dt= 0.01 hrs  
 Peak Elev= 90.24' @ 12.14 hrs Surf.Area= 658 sf Storage= 859 cf

Plug-Flow detention time= 19.4 min calculated for 7,985 cf (100% of inflow)  
 Center-of-Mass det. time= 19.5 min ( 850.8 - 831.3 )

Volume	Invert	Avail.Storage	Storage Description
#1A	88.25'	627 cf	<b>20.50'W x 32.10'L x 3.50'H Field A</b> 2,303 cf Overall - 735 cf Embedded = 1,568 cf x 40.0% Voids
#2A	88.75'	735 cf	<b>ADS_StormTech SC-740 +Cap</b> x 16 Inside #1 Effective Size= 44.6"W x 30.0"H => 6.45 sf x 7.12'L = 45.9 cf Overall Size= 51.0"W x 30.0"H x 7.56'L with 0.44' Overlap 16 Chambers in 4 Rows
		1,362 cf	Total Available Storage

Storage Group A created with Chamber Wizard

Device	Routing	Invert	Outlet Devices
#1	Primary	88.25'	<b>18.0" Round Culvert</b> L= 26.9' CPP, projecting, no headwall, Ke= 0.900 Inlet / Outlet Invert= 88.25' / 88.12' S= 0.0048 '/' Cc= 0.900 n= 0.013 Corrugated PE, smooth interior, Flow Area= 1.77 sf
#2	Device 1	89.95'	<b>4.0' long Sharp-Crested Rectangular Weir</b> 2 End Contraction(s)
#3	Device 1	88.25'	<b>3.0" Vert. Orifice/Grate</b> C= 0.600 Limited to weir flow at low heads

**Primary OutFlow** Max=2.32 cfs @ 12.14 hrs HW=90.24' (Free Discharge)

- ↑ **1=Culvert** (Passes 2.32 cfs of 7.30 cfs potential flow)
- ↑ **2=Sharp-Crested Rectangular Weir** (Weir Controls 1.99 cfs @ 1.75 fps)
- ↑ **3=Orifice/Grate** (Orifice Controls 0.32 cfs @ 6.57 fps)



# Hydraflow 10-Yr Calcs

Prepared by Weston & Sampson

HydroCAD® 10.10-6a s/n 00455 © 2020 HydroCAD Software Solutions LLC

Type III 24-hr 10-year Rainfall=5.12"

Printed 11/5/2021

Page 41

## Pond DS-1: DS-1

Hydrograph

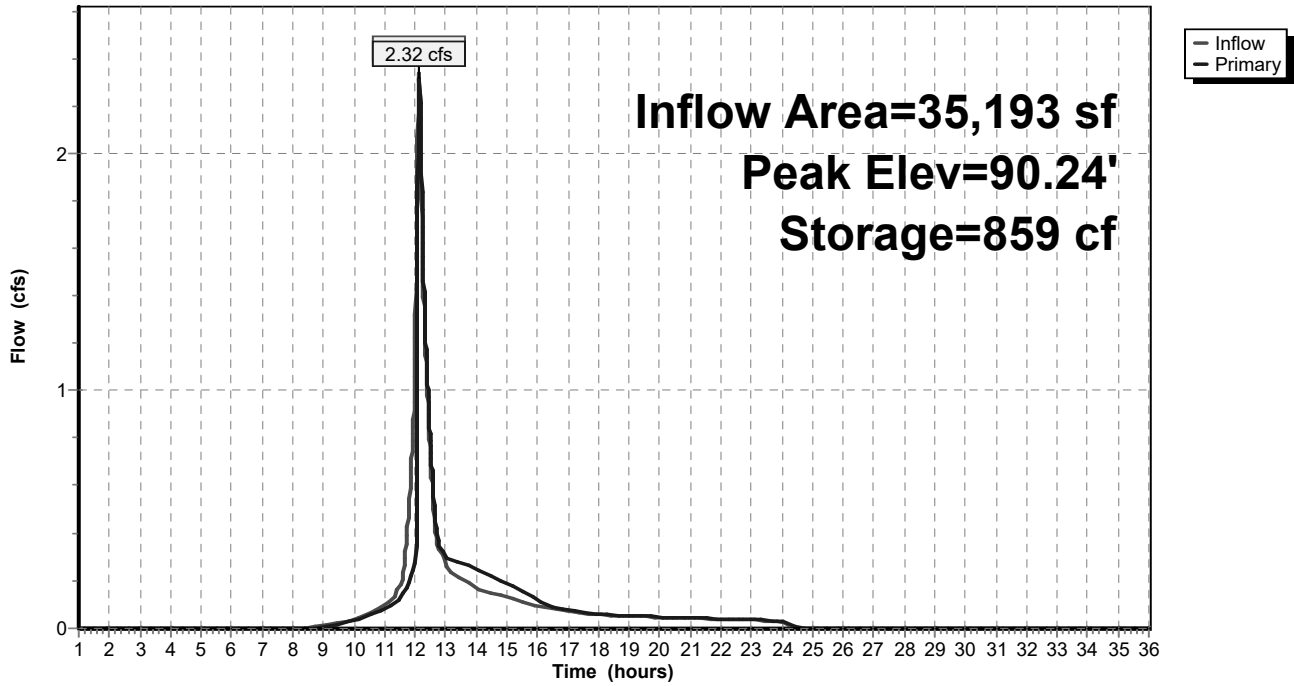

# Hydraflow 10-Yr Calcs

Prepared by Weston & Sampson

HydroCAD® 10.10-6a s/n 00455 © 2020 HydroCAD Software Solutions LLC

Type III 24-hr 10-year Rainfall=5.12"

Printed 11/5/2021

Page 42

## Summary for Pond IS-1: IS-1

Inflow Area = 60,445 sf, 85.10% Impervious, Inflow Depth = 3.89" for 10-year event  
Inflow = 6.27 cfs @ 12.09 hrs, Volume= 19,612 cf  
Outflow = 0.75 cfs @ 12.69 hrs, Volume= 19,612 cf, Atten= 88%, Lag= 36.4 min  
Discarded = 0.26 cfs @ 12.69 hrs, Volume= 13,800 cf  
Primary = 0.49 cfs @ 12.69 hrs, Volume= 5,811 cf  
Routed to nonexistent node A

Routing by Dyn-Stor-Ind method, Time Span= 1.00-36.00 hrs, dt= 0.01 hrs  
Peak Elev= 93.75' @ 12.69 hrs Surf.Area= 3,603 sf Storage= 8,233 cf

Plug-Flow detention time= 161.4 min calculated for 19,606 cf (100% of inflow)  
Center-of-Mass det. time= 161.4 min ( 955.0 - 793.6 )

Volume	Invert	Avail.Storage	Storage Description
#1A	90.50'	5,063 cf	<b>29.92'W x 120.42'L x 5.50'H Field A</b> 19,814 cf Overall - 7,156 cf Embedded = 12,658 cf x 40.0% Voids
#2A	91.25'	7,156 cf	<b>ADS_StormTech MC-3500 d +Cap</b> x 64 Inside #1 Effective Size= 70.4"W x 45.0"H => 15.33 sf x 7.17'L = 110.0 cf Overall Size= 77.0"W x 45.0"H x 7.50'L with 0.33' Overlap 64 Chambers in 4 Rows Cap Storage= 14.9 cf x 2 x 4 rows = 119.2 cf
		12,219 cf	Total Available Storage

Storage Group A created with Chamber Wizard

Device	Routing	Invert	Outlet Devices
#1	Discarded	90.50'	<b>2.410 in/hr Exfiltration over Wetted area</b> Phase-In= 0.01'
#2	Primary	91.50'	<b>12.0" Round Culvert</b> L= 87.6' CPP, projecting, no headwall, Ke= 0.900 Inlet / Outlet Invert= 91.50' / 91.06' S= 0.0050 '/' Cc= 0.900 n= 0.013 Corrugated PE, smooth interior, Flow Area= 0.79 sf
#3	Device 2	95.00'	<b>4.0' long Sharp-Crested Rectangular Weir</b> 2 End Contraction(s)
#4	Device 2	92.20'	<b>4.0" Vert. Orifice/Grate</b> C= 0.600 Limited to weir flow at low heads

**Discarded OutFlow** Max=0.26 cfs @ 12.69 hrs HW=93.75' (Free Discharge)

↑ **1=Exfiltration** (Exfiltration Controls 0.26 cfs)

**Primary OutFlow** Max=0.49 cfs @ 12.69 hrs HW=93.75' (Free Discharge)

↑ **2=Culvert** (Passes 0.49 cfs of 3.79 cfs potential flow)

↑ **3=Sharp-Crested Rectangular Weir** ( Controls 0.00 cfs)

↑ **4=Orifice/Grate** (Orifice Controls 0.49 cfs @ 5.65 fps)

# Hydraflow 10-Yr Calcs

Prepared by Weston & Sampson

HydroCAD® 10.10-6a s/n 00455 © 2020 HydroCAD Software Solutions LLC

Type III 24-hr 10-year Rainfall=5.12"

Printed 11/5/2021

Page 43

## Pond IS-1: IS-1

Hydrograph

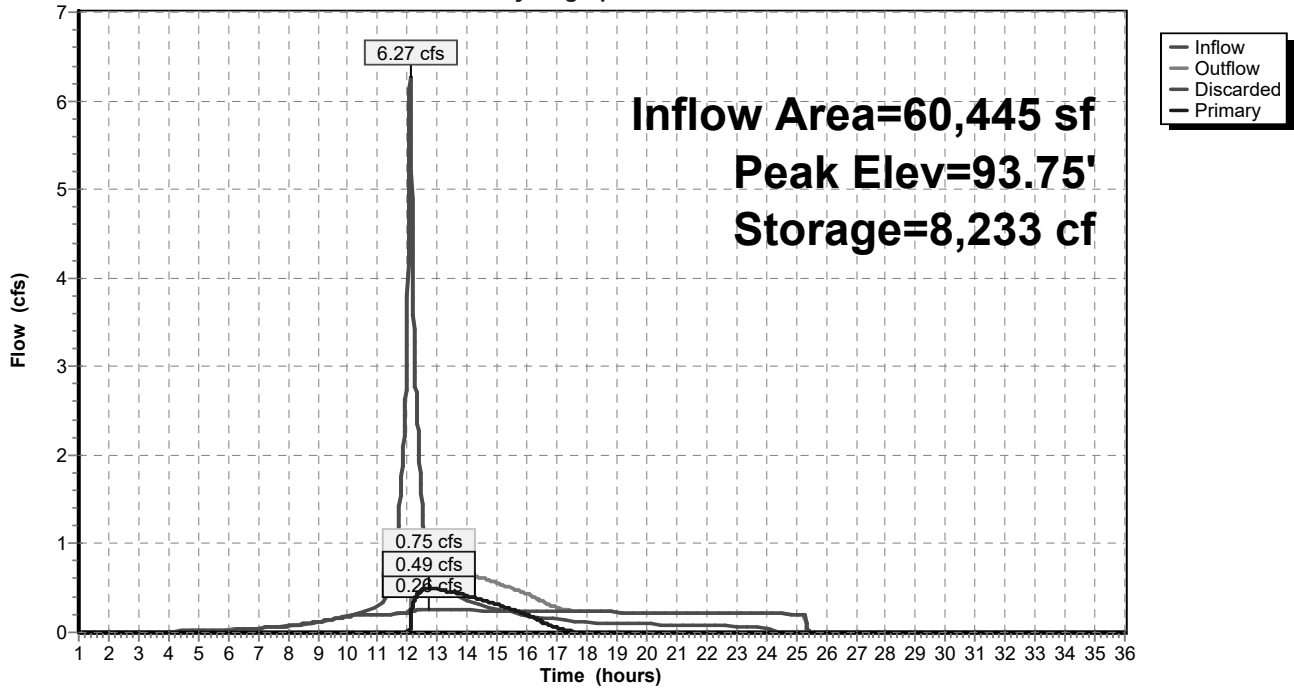

**Attachment F - Long Term Pollution Prevention Plan**

## **Long Term Pollution Prevention Plan Harry Lee Cole School Boxford, MA**

To meet the requirements of Standard 4 of the Massachusetts Stormwater Handbook, this Long Term Pollution Prevention Plan is provided to identify the proper procedures of practices for source control and pollution prevention.

### **Storage and Handling of Oil and other Hazardous Materials**

Any hazardous materials that will be used ancillary to the school will be stored inside, or off site.

### **Spill Prevention/Response**

Spill kits will be kept on site, and spills shall be cleaned up immediately. Spills of any hazardous material over 10 gallons will be reported to the Massachusetts Department of Environmental Protection within 24 hours.

### **Operation and Maintenance of Stormwater Control Structures**

Included in Attachment H of this appendix is the Operation and Maintenance plan for this site, which includes street sweeping of the paved areas and periodic cleaning of stormwater structures. The town will be responsible for the implementation of the plan.

### **Landscaping**

The landscaped areas will be maintained by the town. Use of fertilizers, herbicides, and pesticides shall be allowed for all vegetated areas on site. If kept on site, all chemicals shall be stored under cover. Any storage for fertilizers, herbicides and pesticides shall not be located within 100 feet of any wetland or within proximity to the stormwater management system where spills could enter the storm drain system.

### **Septic System**

There will be no new onsite septic facilities. The sewer facilities currently in use for the existing building on site shall be retained.

### **Vehicle Washing**

Vehicle washing shall not be performed on site. Vehicles can be rinsed with a high volume of water at low pressure. This is considered dust water by the DEP and accounts for what may be rinsed off of the vehicle when it rains. Pre-treatment BMP's downstream of these activities will include deep-sump hooded catch basins.

### **Non-Hazardous Waste Management/Good Housekeeping Practices**

All non-hazardous waste shall be stored in designated trash or recycling containers onsite for periodic collection by the local trash collector. The town shall have maintenance staff who monitor the site for the accumulation of trash. Any trash that is seen onsite shall immediately be collected and placed into designated trash or recycling containers. The town's maintenance staff shall inspect the site once per week at minimum.

### **Prohibition of Illicit Discharges**

Illicit discharges to the onsite stormwater management system shall be strictly prohibited. Illicit discharges are defined as any direct or indirect non-stormwater discharge to the onsite stormwater system. Requirements related to Illicit Discharges are further detailed in the attached Illicit Discharge Compliance Statement.

### **De-icing & Snow Disposal**

The operation will utilize salt and sand to treat the paved surfaces of the site during snow and ice events. Use of salt shall be restricted in areas where stormwater drains to the bioretention area. Snow will be temporarily stored within peripheral areas of the site and allowed to melt and drain back to onsite stormwater systems. When needed, snow shall be removed from the site and disposed of in accordance with all local, state and federal regulations. Snow storage shall be prohibited within all wetlands and wetland buffer zones.

### **Winter Sand/Salt Use & Storage**

Any sand and/or salt to be used for de-icing purposes shall be stored inside or under cover and stabilized to prevent the discharge into nearby wetlands or waterbodies.

**Emergency Contact Information**

**Owner/Operator:**

Tri-Town School Union  
Stephen Clifford  
Director of Facilities  
26 Middleton Road  
Boxford, MA 01921

**Engineer:**

James Pearson, P.E.  
Weston & Sampson, Inc.  
55 Walkers Brook Drive, Suite 100  
Reading, MA 01867  
978-532-1900

**Attachment G - Construction Period Pollution and Erosion  
and Sedimentation Control Plan**



# **Construction Period Pollution Prevention and Erosion and Sedimentation Control Plan**

## **SECTION 1: Introduction**

The project applicant, the Town of Boxford, proposes a redevelopment project at the Harry Lee Cole School located at 26 Middleton Road in Boxford to improve site access and traffic circulation. Site work will include, but is not limited to grading, drainage, paving and landscaping.

As part of this project, this “Construction Period Pollution Prevention and Erosion and Sedimentation Control Plan” has been created to ensure that onsite erosion is prevented and sediment is controlled to prevent it from leaving the site.

## **SECTION 2: Construction Period Pollution Prevention Measures**

Best Management Practices (BMPs) will be utilized as Construction Period Pollution Prevention Measures to reduce potential pollutants and prevent any off-site discharge. The objectives of the BMPs for construction activity are to minimize the disturbed areas, stabilize any disturbed areas, control the site perimeter and retain sediment. Both erosion and sedimentation controls and non-stormwater best management measures will be used to minimize site disturbance and ensure compliance with the performance standards of the WPA and Stormwater Standards. Measures will be taken to minimize the area disturbed by construction activities to reduce the potential for soil erosion and stormwater pollution problems. All pollution prevention and erosion control measures which are required on the site plans and in the SWPPP shall be followed along with the guidance in this document. In addition, good housekeeping measures will be followed for the day-to-day operation of the construction site under the control of the contractor to minimize the impact of construction. This section describes the control practices that will be in place during construction activities. All recommended control practices will comply with the standards set in the MA DEP Stormwater Policy Handbook.

### **2.1 Minimize Disturbed Area and Protect Natural Features and Soil**

In order to minimize disturbed areas all work will be completed within well-defined work limits. These work limits are shown on the construction plans. The Contractor shall not disturb native vegetation in the undisturbed wooded area without prior approval from the Engineer. The Contractor will be responsible to make sure that all workers know the proper work limits and do not extend their work into the undisturbed areas. The protective measures are described in more detail in the following sections.

## **2.2 Control Stormwater Flowing onto and through the project**

All construction areas adjacent to drainage features will be lined with compost filter tubes and silt fence. The tubes and silt fence will be inspected daily and accumulated silt will be removed as appropriate. In addition, any storage of material will require a second level of protection by surrounding the areas with another row of compost filter tubes. A stabilized construction entrance/exit is proposed so that equipment visiting the site can remove any accumulated dirt and mud from vehicles to prevent tracking the mud onto public roads.

## **2.3 Stabilize Soils**

The Contractor shall limit the area of land which is exposed and free from vegetation during construction. In areas where the period of exposure will be greater than two (2) months, mulching, the use of erosion control mats, or other protective measures shall be provided as specified.

The Contractor shall take account of the conditions of the soil where erosion control seeding will take place to ensure that materials used for re-vegetation are adaptive to the sediment control.

Following the completion of construction, embankment areas will be finished with topsoil and seed. Slopes in excess of 3H:1V will be stabilized with erosion matting to prevent erosion during the interim period in which vegetation is being established. The overland areas of the proposed construction staging areas will also be re-seeded.

## **2.4 Proper storage and cover of any stockpiles**

The location of the Contractor's storage areas for equipment and/or materials shall be upon cleared portions of the job site or areas to be cleared as a part of this project and shall require written approval of the Engineer.

Adequate measures for erosion and sediment control such as the placement of compost filter tubes around the downstream perimeter of stockpiles shall be employed to protect any downstream areas from siltation.

The Engineer may designate a particular area or areas where the Contractor may store materials used in his operations.

## **2.5 Perimeter Controls and Sediment Barriers**

Erosion control lines as described in Section 5 will be utilized to ensure that no sedimentation occurs outside the perimeter of the work area.

## **2.6 Storm Drain Inlet Protection**

Storm drain inlets will be protected from sediment.

## **2.7 Retain Sediment On-Site**

The Contractor will be responsible to monitor all erosion control measures. Whenever necessary the Contractor will clear all sediment from the compost filter tubes and silt fence that have been silted up during construction. Daily monitoring should be conducted using the attached Monitoring Form.

The following good housekeeping practices will be followed on-site during the construction project.

## **2.8 Material Handling and Waste Management**

All materials stored on-site will be stored in a neat, orderly manner in appropriate containers. All materials will be kept in their original containers with the original manufacturer's label. Substances will not be mixed with one another unless recommended by the manufacturer.

All waste materials will be collected and stored in a securely lidded metal container from a licensed management company. The waste and any construction debris from the site will be hauled off-site daily and disposed of properly. The contractor will be responsible for all waste removal. Manufacturer's recommendations for proper use and disposal will be followed for all materials. Sanitary waste will be collected from the portable units a minimum of once a week, by a licensed sanitary waste management contractor.

## **2.9 Designated Washout Areas**

The Contractor shall perform washout into contained areas designated for that purpose to prevent cement-laden water from leaving the site.

## **2.10 Proper Equipment/Vehicle Fueling and Maintenance Practices**

On-site vehicles will be monitored for leaks and receive regular preventative maintenance to reduce the risk of leakage. To ensure that leaks on stored equipment do not contaminate the site, oil-absorbing mats will be placed under all equipment during storage. Regular fueling and service of the equipment may be performed using approved methods and with care taken to minimize chance of spills. Any petroleum products will be stored in tightly sealed containers that are clearly labeled.

## **2.11 Equipment/Vehicle Washing**

The Contractor will be responsible to ensure that no equipment is washed on-site.

## **SECTION 3: Spill Prevention and Control Plan**

The Contractor will be responsible for preventing spills in accordance with the project specifications and applicable federal, state and local regulations. The Contractor will identify a properly trained site employee, involved with the day-to-day site operations to be the spill prevention and cleanup coordinator. The name(s) of the responsible spill personnel will be posted on-site. Each employee will be instructed that all spills are to be reported to the spill prevention and cleanup coordinator.

### **3.1 Spill Control Equipment**

Spill control/containment equipment will be kept in the Work Area. Materials and equipment necessary for spill cleanup will be kept either in the Work Area or in an otherwise accessible on-site location. Equipment and materials will include, but not be limited to, absorbent booms/mats, brooms, dust pans, mops, rags, gloves, goggles, sand, plastic and metal containers specifically for this purpose. It is the responsibility of the Contractor to ensure the inventory will be readily accessible and maintained.

### **3.2 Notification**

All workers will be directed to inform the on-site supervisor of a spill event. The supervisor will assess the incident and initiate proper containment and response procedures immediately upon notification. Workers should avoid direct contact with spilled materials during the containment procedures. Primary notification of a spill should be made to the local Fire Department and Police Departments. Secondary Notification will be to the certified cleanup contractor if deemed necessary by Fire and/or Police personnel. The third level of notification is to the DEP. The specific cleanup contractor to be used will be identified by the Contractor prior to commencement of construction activities.

### **3.3 Spill Containment and Clean-Up Measures**

Spills will be contained with granular sorbent material, sand, sorbent pads, booms or all of the above to prevent spreading. Certified cleanup contractors should complete spill cleanup. The material manufacturer's recommended methods for spill cleanup will be clearly posted and on-site personnel will be

made aware of the procedures and the location of the information and cleanup supplies.

### **3.4 Hazardous Materials Spill Report**

The Contractor will report and record any spill. The spill report will present a description of the release, including the quantity and type of material, date of the spill, circumstances leading to the release, location of spill, response actions and personnel, documentation of notifications and corrective measures implemented to prevent reoccurrence.

*This document does not relieve the Contractor of the Federal reporting requirements of 40 CFR Part 110, 40 CFR Part 117, 40 CFR Part 302 and the State requirements specified under the Massachusetts Contingency Plan (M.C.P) relating to spills or other releases of oils or hazardous substances. Where a release containing a hazardous substance or oil in an amount equal to or in excess of a reportable quantity established under either 40 CFR Part 110, 40 CFR Part 117 or 40 CFR Part 302, occurs during a twenty-four (24) hour period, the Contractor is required to comply with the response requirements of the above mentioned regulations. Spills of oil or hazardous material in excess of the reportable quantity will be reported to the National Response Center (NRC).*

## **SECTION 4: Contact Information/Responsible Parties**

**Owner/Operator:**

Tri-Town School Union  
Stephen Clifford  
Director of Facilities  
26 Middleton Road  
Boxford, MA 01921  
978-887-0771

**Engineer:**

James Pearson, P.E.  
Weston & Sampson, Inc.  
55 Walkers Brook Drive, Suite 100  
Reading, MA 01867  
978-532-1900

**Site Inspector:**

TBD

**Contractor:**

TBD

## SECTION 5: Erosion and Sedimentation Control

Erosion and Sedimentation Controls are shown on the project plans. A Stormwater Pollution Prevention Plan (SWPPP) will be required for this project in accordance with EPA regulations. The contractor shall refer to the SWPPP for additional requirements.

## SECTION 6: Site Development Plans

A full set of site development plans are included with this submittal.

## SECTION 7: Operation and Maintenance of Erosion Control

If there is a failure to the controls the Contractor, under the supervision of the Engineer, will be required to stop work until the failure is repaired.

Periodically throughout the work, whenever the Engineer deems it necessary, the sediment that has been deposited against the controls will be removed to ensure that the controls are working properly.

## SECTION 8: Inspection Schedule

During construction the erosion and sedimentation controls will be inspected daily. Once the Contractor is selected, an on site inspector will be selected to work closely with the Engineer to insure that all erosion and sedimentation controls are in place and working properly. An Inspection Form is included.

**Construction Period Pollution Prevention and Erosion and Sedimentation Control Plan**

Harry Lee Cole School – Boxford, MA

Inspection Form

Inspected By: \_\_\_\_\_ Date: \_\_\_\_\_ Time: \_\_\_\_\_

YES	NO	DOES NOT APPLY	ITEM
			Do any erosion/siltation control measures require repair or clean out to maintain adequate function?
			Is there any evidence that sediment is leaving the site and entering the wetlands?
			Are any temporary soil stockpiles or construction materials located in non-approved areas?
			Are on-site construction traffic routes, parking, and storage of equipment and supplies located in areas not specifically designed for them?
			Is there any evidence that sediment is entering subsurface stormwater chamber systems?

Specific location, current weather conditions, and action to be taken:

---

---

---

---

---

---

---

---

Other Comments:

---

---

---

Pending the actions noted above I certify that the site is in compliance with the Construction Period Pollution Prevention and Erosion and Sedimentation Control Plan.

Signature: \_\_\_\_\_ Date: \_\_\_\_\_

## **Attachment H - Operations and Maintenance Plan**



## **1.0 Introduction**

The following document has been written to comply with the stormwater guidelines set forth by the Massachusetts Department of Environmental Protection (MassDEP). The intent of these guidelines is to encourage Low Impact Development techniques to improve the quality of the stormwater runoff. These techniques, also known as Best Management Practices (BMPs) collect, store, and treat the runoff before discharging to adjacent environmental resources.

## **2.0 Purpose**

This Operation and Maintenance Plan (O&M Plan) is intended to provide a mechanism for the consistent inspection and maintenance of each BMP installed on the project site. Included in this O&M Plan is a description of each BMP type and an inspection form for each BMP. The Town of Boxford is the owner and operator of the system and is responsible for its upkeep and maintenance. This work will be funded on an annual basis through the owner's operating budget.

In the event the Owner sells the property, it is the Owner's responsibility to transfer this plan as well as the design plans, shop drawings, as-built plans, and past three years of operation and maintenance records to the new property owner.

## **3.0 BMP Description and Locations**

### 3.1 Street Sweeping

Street sweeping consists of using a sweeper machine to clean impervious areas of accumulated sediment, debris, and trash at paved areas.

### 3.2 Deep Sump Catch Basins

Deep sump catch basins utilizing catch basin hoods will be located throughout the site and used as pre-treatment before entering the infiltration systems or other Town stormwater infrastructure. The deep sump catch basins are designed to remove trash, debris, hydrocarbons, and coarse sediment from the stormwater runoff.

### 3.3 Stormtech Isolator Row

The subsurface chamber systems will contain a Stormtech Isolator Row for TSS removal. The Isolator Row consists of Stormtech stormwater chambers wrapped in geotextile fabric.

#### 3.4 Stormtech Subsurface Chamber System

The subsurface chamber systems use infiltration or detention to mitigate peak runoff rates from the site. The structure also significantly mitigates TSS.

#### 3.5 Outlet Control Structure

The outlet control structures are used to control discharges from captured stormwater. They release the water in a controlled manner to control peak discharges.

#### 3.6 Drain Manholes

Drain Manholes will be located throughout the site and used to convey and redirect stormwater collected from deep sump catch basins. They allow for access, connection points, and change-in-direction points in the underground drainage system.

#### 3.7 Bioretention Area

Bioretention areas mitigate peak runoff rates and filter stormwater to provide treatment, significantly reducing TSS as well as phosphorus, nitrogen and heavy metals. The bioretention area also includes pre-treatment devices to reduce TSS prior to entering the ponding area.

### **4.0 Inspection, Maintenance Checklist and Schedule**

#### 4.1 Street Sweeping

Street sweeping shall be performed on all impervious surfaces on a quarterly average, with sweeping performed primarily in the spring and fall. Street sweeping shall be performed using a high efficiency vacuum street sweeping machine or a regenerative air sweeper. A mechanical rotary broom sweeper may be used if sweeping is performed on a monthly basis.

In the event of contamination by a spill or other means, all street sweeping cleanings must be evaluated in accordance with the Hazardous Waste Regulations, 310 CMR 30.000 and handled as hazardous waste.

In the absence of evidence of contamination, street sweeping cleanings may be taken to a landfill or other facility permitted by MassDEP to accept Solid Waste without any prior approval by MassDEP. Please note that current MassDEP regulations prevent landfills from accepting materials that contain free-draining liquids.

#### 4.2 Deep Sump Catch Basins and Outlet Control Structures

Inspect and/or clean catch basin and outlet control structures at least four times per year and at the end of foliage and snow removal seasons. Sediments must be removed whenever the depth of deposits is greater than or equal to one half the depth from the bottom of the invert of the lowest pipe in the basin. The structures should be cleaned a minimum of four times per year regardless of the amount of sediment in the basin. If catch basins are found to be filled to capacity with sediment during a cleaning, the frequency of cleaning shall be increased. Catch basins and outlet control structures shall be cleaned with clamshell buckets or by hand tools where necessary. Catch basin hoods shall be inspected annually. Open and close the access hatch and flush or rod the anti-siphon device to ensure proper operation.

In the event of contamination by a spill or other means, all cleanings must be evaluated in accordance with the Hazardous Waste Regulations, 310 CMR 30.000 and handled as hazardous waste.

In the absence of evidence of contamination, catch basin cleanings may be taken to a landfill or other facility permitted by MassDEP to accept Solid Waste without any prior approval by MassDEP. Please note that current MassDEP regulations prevent landfills from accepting materials that contain free-draining liquids.

#### 4.3 Stormtech Isolator Row

Stormtech Isolator Rows shall be inspected every six months for the first year, then timed thereafter based upon the depth of sediment build up witnessed in the previous inspections. Inspection ports shall be located strategically throughout the isolator row system. When sediment is observed, the depth shall be recorded with a stadia rod, and when that average depth across the chambers reaches 3-inches, the system shall be cleaned out.

Cleaning is performed through the Jet-vac process whereby the chambers are washed with a high-pressure water system and the captured pollutants are then vacuumed out.

Refer to the attached Stormtech Isolator Row Operations and Maintenance document for additional information.

#### 4.4 Stormtech Subsurface Chamber System

Stormtech subsurface chambers shall be inspected every three months for the first year, then timed thereafter based upon the depth of sediment build up witnessed in the previous inspections. Inspection ports shall be located strategically throughout the isolator row system. When sediment is observed, the depth shall be recorded with a stadia rod, and when that average depth across the isolator row reached 3-inches, the system shall be cleaned out.

Cleaning is performed through the Jet-vac process whereby the isolator chambers are washed with a high-pressure water system and the captured pollutants are then vacuumed out.

Refer to the attached Stormtech Operations and Maintenance document for additional information.

#### 4.5 Drain Manholes

Inspect and/or clean drain manholes at least four times per year while inspecting the catch basins. Remove all accumulated sediments and debris, and dispose of in accordance with local, state, and federal regulations. Drain Manholes shall be cleaned with clamshell buckets or by hand tools where necessary.

In the event of contamination by a spill or other means, all cleanings must be evaluated in accordance with the Hazardous Waste Regulations, 310 CMR 30.000 and handled as hazardous waste.

In the absence of evidence of contamination, manhole cleanings may be taken to a landfill or other facility permitted by MassDEP to accept Solid Waste without any prior approval by MassDEP. Please note that current MassDEP regulations prevent landfills from accepting materials that contain free-draining liquids.

#### 4.6 Inspections and Record Keeping

- An inspection form should be filled out each and every time maintenance work is performed.
- A binder should be kept at the facility that contains all of the completed inspection forms and any other related materials.
- A review of all Operation & Maintenance actions should take place annually to ensure that these Stormwater BMPs are being taken

care of in the manner illustrated in this Operation & Maintenance Plan.

- All operation and maintenance log forms for the last three years, at a minimum, shall be kept on site at the facility.
- The inspection and maintenance schedule may be refined in the future based on the findings and results of this operation and maintenance program or policy.

#### 4.7 Bioretention Area

Premature failure of bioretention areas is a significant problem caused by lack of regular maintenance. Careful attention must be paid while plantings are being established and seasonal landscaping maintenance is required thereafter. Maintenance shall be conducted in accordance with the following schedule:

Activity	Time of Year	Frequency
Inspect & remove trash	Year round	Monthly
Mulch	Spring	Annually
Remove dead vegetation	Fall or Spring	Annually
Replace dead vegetation	Spring	Annually
Prune	Spring or Fall	Annually
Replace entire media & all vegetation	Late Spring/early Summer	As needed*

\*Paying careful attention to pretreatment and operation & maintenance can extend the life of the soil media

Basin inspection should include checking for rilling, gullyng and other signs of erosion. When encountered, repairs shall be made immediately. Debris and litter should be removed while inspecting for erosion.

Care must be taken to maintain the plants in the basin. Salt use must be restricted where runoff flows to the bioretention areas to maintain the plantings.

Pre-treatment for the bioretention area includes a stone diaphragm and a grassed filter strip. The stone diaphragm must be cleaned of debris on a monthly basis and also checked for sediment accumulation annually or whenever excessive ponding is witnessed. The stone must be removed from the trench, and all sediment removed by hand. Grassed filter strips should be checked for rilling, gullyng and erosion. When encountered, repair immediately. Remove all litter and debris and mow on a regular basis while performing regular landscape maintenance.

**5 Stormwater Management System Owner/Responsible Party**

The stormwater management system shall be owned and maintained by the following party or its future designee/assigns:

Tri-Town School Union  
Stephen Clifford – Director of Facilities  
26 Middleton Road  
Boxford, MA 01921

This operation and Maintenance Plan will be recorded with the registry of deeds so that current and future owners are aware of the requirement for proper operation and maintenance of the onsite stormwater system.

**6 General Good Housekeeping Practices**

All non-hazardous waste shall be stored in designated trash or recycling containers onsite for periodic collection by the local trash collector. The owner shall have maintenance staff who monitor the site for the accumulation of trash. Any trash that is seen onsite shall immediately be collected and placed into designated trash or recycling containers. The owner's maintenance staff shall make an inspection of the site once per week at minimum.

**7 Estimated Operations and Maintenance Budget**

The estimated budget for annual operations and maintenance of this stormwater system is \$2,000 per year.

Harry Lee Cole School  
Permanent BMP Inspection Checklist

**Street Sweeping**

Frequency: Quarterly average, primarily in the spring and fall if using a high efficiency vacuum sweeper or regenerative air sweeper. Monthly, if using a mechanical rotary broom sweeper.

Location: Parking Areas, Driveways and Roadway

Inspected By: \_\_\_\_\_ Date: \_\_\_\_\_

Observations: \_\_\_\_\_  
\_\_\_\_\_  
\_\_\_\_\_

Actions Taken: \_\_\_\_\_  
\_\_\_\_\_  
\_\_\_\_\_

Instructions: Sweep all impervious areas, including parking lots, driveways, and roadways using high efficiency vacuum street sweeping machine, regenerative air sweeper, or mechanical rotary broom sweeper. All trash, debris, and sediments should be disposed of in accordance with local, state, and federal regulations.

## Deep Sump Catch Basins & Outlet Control Structures

Frequency: Inspect and clean deep sump catch basins and outlet control structures in March, June, September and December.

Structure Number: \_\_\_\_\_

Inspected By: \_\_\_\_\_ Date: \_\_\_\_\_

Observations: \_\_\_\_\_  
\_\_\_\_\_  
\_\_\_\_\_

Actions Taken: \_\_\_\_\_  
\_\_\_\_\_  
\_\_\_\_\_

Instructions: Clean units four times per year or whenever the depth of the deposits is greater than or equal to one half the depth from the bottom of the invert to the lowest pipe in the structure. Open and close hood and check anti-siphon vent for clogging.



## Subsurface Chamber System & Isolator Row

Frequency: Inspect and clean chamber system and isolator row every six months for the first year and annually thereafter.

Structure Number: \_\_\_\_\_

Inspected By: \_\_\_\_\_ Date: \_\_\_\_\_

Observations: \_\_\_\_\_  
\_\_\_\_\_  
\_\_\_\_\_

Actions Taken: \_\_\_\_\_  
\_\_\_\_\_  
\_\_\_\_\_

Instructions: Clean the system whenever the depth of the deposits averages three inches in depth across the bottom of the chambers. Inspect chambers via manholes or inspection ports. Use reverse water jet to pull sediment back into manhole. Remove sediment, trash and debris as noted above. Refer to StormTech maintenance documentation on isolator rows for more information.

**Drain Manholes**

Frequency: Inspect and clean drain manholes in March, June, September and December.

Structure Number: \_\_\_\_\_

Inspected By: \_\_\_\_\_ Date: \_\_\_\_\_

Observations: \_\_\_\_\_  
\_\_\_\_\_  
\_\_\_\_\_

Actions Taken: \_\_\_\_\_  
\_\_\_\_\_  
\_\_\_\_\_

Instructions: Clean units four times per year at a minimum, or whenever catch basins are inspected. Remove sediment and debris. All debris, and sediments should be disposed of in accordance with local, state, and federal regulations. Drain Manholes shall be cleaned with clamshell buckets or by hand tools where necessary.

**Bioretention Area & Pre-treatment Devices**

Frequency: Inspect and clean monthly. Perform seasonal landscaping maintenance twice a year.

Structure Number: \_\_\_\_\_

Inspected By: \_\_\_\_\_ Date: \_\_\_\_\_

Observations: \_\_\_\_\_  
\_\_\_\_\_  
\_\_\_\_\_

Actions Taken: \_\_\_\_\_  
\_\_\_\_\_  
\_\_\_\_\_

Instructions: Remove accumulated trash and debris. Remove sediment and re-mulch bare spots as needed in basin. Inspect pipe inlets for damage, erosion or blockage, remove blockage as needed, repair erosion where needed. Remove and replace dead vegetation and prune as needed. Mow the grassed filter strip at a minimum of once a month while removing trash and debris. On an annual basis, or when excessive ponding is witnessed, remove sediment from the stone strip/diaphragm. All stone must be removed from the trench and sediment removed by hand. All trash, debris, and sediments should be disposed of in accordance with local, state, and federal regulations.

**LEGEND**

- CB CATCH BASIN
- DMH DRAIN MANHOLE
- ICS INLET CONTROL STRUCTURE
- OCS OUTLET CONTROL STRUCTURE

Project: **BOXFORD PUBLIC SCHOOLS SITE RENOVATION PROJECT**

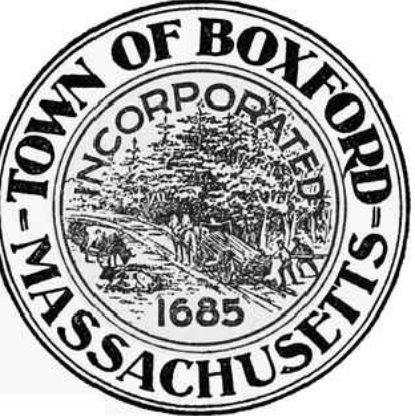

TOWN OF BOXFORD  
BOXFORD, MA 01921

**Weston & Sampson**  
Weston & Sampson Engineers, Inc.  
55 Walkers Brook Drive, Suite 100  
Reading, MA 01867  
978.532.1900 800.SAMPSON  
www.westonandsampson.com

Consultants:

Revisions:

No.	Date	Description
1	08/24/21	PER REVISED LAYOUT
2	11/01/21	PER PEER REVIEW

Seal:

Issued For:

Scale:

Date:

Drawn By:

Reviewed By:

Approved By:

W&S Project No.: ENG20-0865  
W&S File No.:

Drawing Title:

**O&M KEY PLAN**

Sheet Number:

**FIG-3**

Rev. 1.8 Date: 10/24/2019

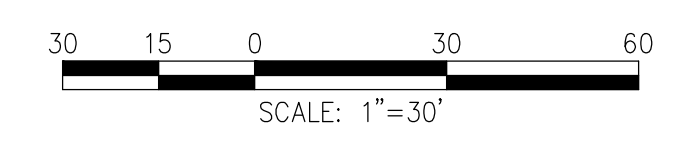
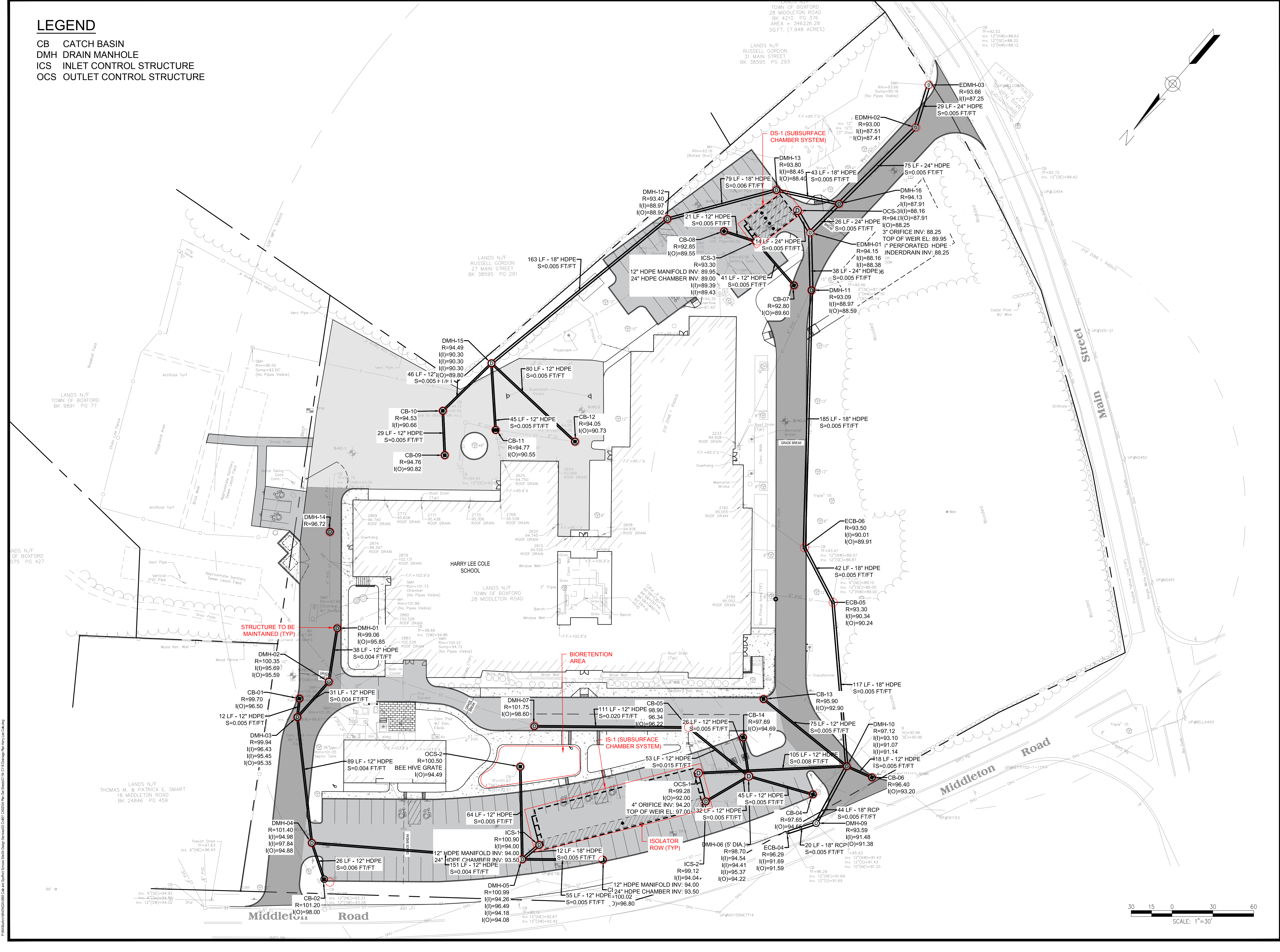

P:\Projects\2020\ENG20-0865\Boxford Public Schools Site Renovation\DWG\FIG-3 O&M Key Plan.dwg

Rev. 1.8 Date: 10/24/2019

# Isolator<sup>®</sup> Row O&M Manual



## THE ISOLATOR<sup>®</sup> ROW

### INTRODUCTION

An important component of any Stormwater Pollution Prevention Plan is inspection and maintenance. The StormTech Isolator Row is a technique to inexpensively enhance Total Suspended Solids (TSS) removal and provide easy access for inspection and maintenance.

### THE ISOLATOR ROW

The Isolator Row is a row of StormTech chambers, either SC-160LP, SC-310, SC-310-3, SC-740, DC-780, MC-3500 or MC-4500 models, that is surrounded with filter fabric and connected to a closely located manhole for easy access. The fabric-wrapped chambers provide for settling and filtration of sediment as storm water rises in the Isolator Row and ultimately passes through the filter fabric. The open bottom chambers and perforated sidewalls (SC-310, SC-310-3 and SC-740 models) allow storm water to flow both vertically and horizontally out of the chambers. Sediments are captured in the Isolator Row protecting the storage areas of the adjacent stone and chambers from sediment accumulation.

Two different fabrics are used for the Isolator Row. A woven geotextile fabric is placed between the stone and the Isolator Row chambers. The tough geotextile provides a media for storm water filtration and provides a durable surface for maintenance operations. It is also designed to prevent scour of the underlying stone and remain intact during high pressure jetting. A non-woven fabric is placed over the chambers to provide a filter media for flows passing through the perforations in the sidewall of the chamber. The non-woven fabric is not required over the SC-160LP, DC-780, MC-3500 or MC-4500 models as these chambers do not have perforated side walls.

The Isolator Row is typically designed to capture the “first flush” and offers the versatility to be sized on a volume basis or flow rate basis. An upstream manhole not only provides access to the Isolator Row but typically includes a high flow weir such that storm water flowrates or volumes that exceed the capacity of the Isolator Row overtop the overflow weir and discharge through a manifold to the other chambers.

The Isolator Row may also be part of a treatment train. By treating storm water prior to entry into the chamber system, the service life can be extended and pollutants such as hydrocarbons can be captured. Pre-treatment best management practices can be as simple as deep sump catch basins, oil-water separators or can be innovative storm water treatment devices. The design of the treatment train and selection of pretreatment devices by the design engineer is often driven by regulatory requirements. Whether pretreatment is used or not, the Isolator Row is recommended by StormTech as an effective means to minimize maintenance requirements and maintenance costs.

*Note: See the StormTech Design Manual for detailed information on designing inlets for a StormTech system, including the Isolator Row.*



Looking down the Isolator Row from the manhole opening, woven geotextile is shown between the chamber and stone base.



StormTech Isolator Row with Overflow Spillway (not to scale)

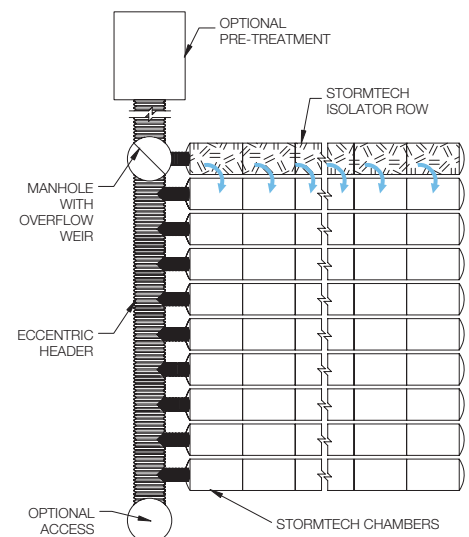

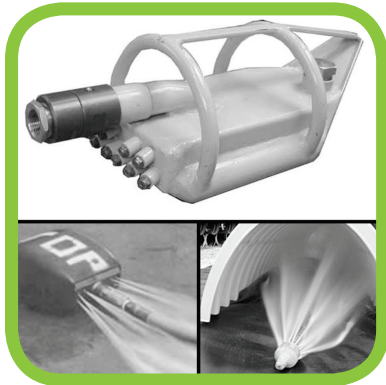

## ISOLATOR ROW INSPECTION/MAINTENANCE

### INSPECTION

The frequency of inspection and maintenance varies by location. A routine inspection schedule needs to be established for each individual location based upon site specific variables. The type of land use (i.e. industrial, commercial, residential), anticipated pollutant load, percent imperviousness, climate, etc. all play a critical role in determining the actual frequency of inspection and maintenance practices.

At a minimum, StormTech recommends annual inspections. Initially, the Isolator Row should be inspected every 6 months for the first year of operation. For subsequent years, the inspection should be adjusted based upon previous observation of sediment deposition.

The Isolator Row incorporates a combination of standard manhole(s) and strategically located inspection ports (as needed). The inspection ports allow for easy access to the system from the surface, eliminating the need to perform a confined space entry for inspection purposes.

If upon visual inspection it is found that sediment has accumulated, a stadia rod should be inserted to determine the depth of sediment. When the average depth of sediment exceeds 3 inches throughout the length of the Isolator Row, clean-out should be performed.

### MAINTENANCE

The Isolator Row was designed to reduce the cost of periodic maintenance. By “isolating” sediments to just one row, costs are dramatically reduced by eliminating the need to clean out each row of the entire storage bed. If inspection indicates the potential need for maintenance, access is provided via a manhole(s) located on the end(s) of the row for cleanout. If entry into the manhole is required, please follow local and OSHA rules for a confined space entries.

Maintenance is accomplished with the JetVac process. The JetVac process utilizes a high pressure water nozzle to propel itself down the Isolator Row while scouring and suspending sediments. As the nozzle is retrieved, the captured pollutants are flushed back into the manhole for vacuuming. Most sewer and pipe maintenance companies have vacuum/JetVac combination vehicles. Selection of an appropriate JetVac nozzle will improve maintenance efficiency. Fixed nozzles designed for culverts or large diameter pipe cleaning are preferable. Rear facing jets with an effective spread of at least 45” are best. Most JetVac reels have 400 feet of hose allowing maintenance of an Isolator Row up to 50 chambers long. **The JetVac process shall only be performed on StormTech Isolator Rows that have AASHTO class 1 woven geotextile (as specified by StormTech) over their angular base stone.**

### StormTech Isolator Row (not to scale)

*Note: Non-woven fabric is only required over the inlet pipe connection into the end cap for SC-160LP, DC-780, MC-3500 and MC-4500 chamber models and is not required over the entire Isolator Row.*

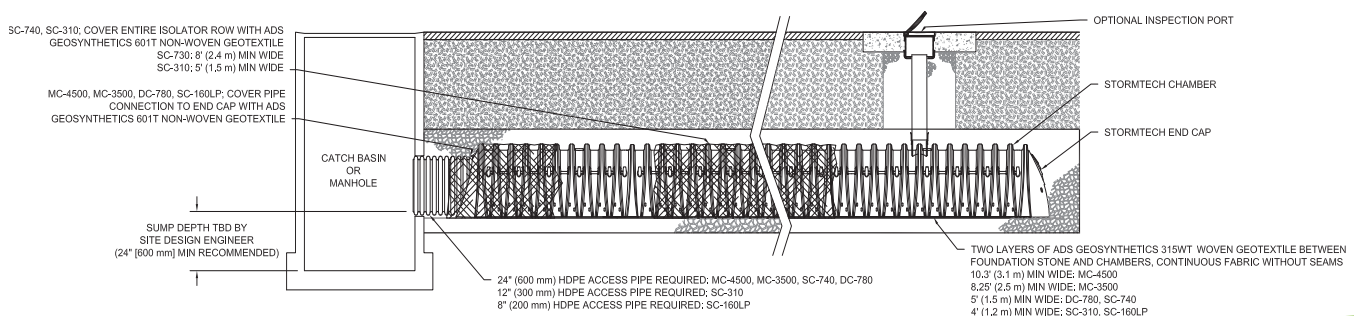

# ISOLATOR ROW STEP BY STEP MAINTENANCE PROCEDURES

## STEP 1

Inspect Isolator Row for sediment.

- A) Inspection ports (if present)
  - i. Remove lid from floor box frame
  - ii. Remove cap from inspection riser
  - iii. Using a flashlight and stadia rod, measure depth of sediment and record results on maintenance log.
  - iv. If sediment is at or above 3 inch depth, proceed to Step 2. If not, proceed to Step 3.
- B) All Isolator Rows
  - i. Remove cover from manhole at upstream end of Isolator Row
  - ii. Using a flashlight, inspect down Isolator Row through outlet pipe
    - 1. Mirrors on poles or cameras may be used to avoid a confined space entry
    - 2. Follow OSHA regulations for confined space entry if entering manhole
  - iii. If sediment is at or above the lower row of sidewall holes (approximately 3 inches), proceed to Step 2. If not, proceed to Step 3.

## STEP 2

Clean out Isolator Row using the JetVac process.

- A) A fixed floor cleaning nozzle with rear facing nozzle spread of 45 inches or more is preferable
- B) Apply multiple passes of JetVac until backflush water is clean
- C) Vacuum manhole sump as required

## STEP 3

Replace all caps, lids and covers, record observations and actions.

## STEP 4

Inspect & clean catch basins and manholes upstream of the StormTech system.

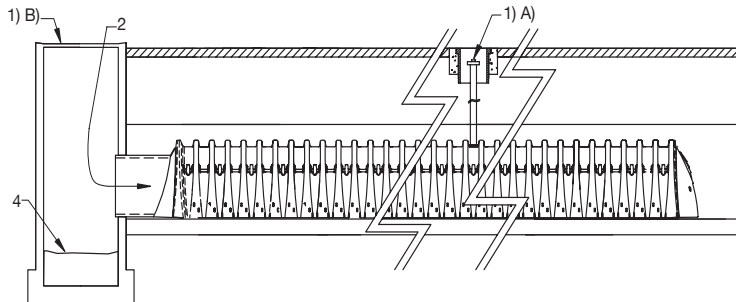

## SAMPLE MAINTENANCE LOG

Date	Stadia Rod Readings		Sediment Depth (1)-(2)	Observations/Actions	Inspector
	Fixed point to chamber bottom (1)	Fixed point to top of sediment (2)			
3/15/11	6.3 ft	none		New installation. Fixed point is CI frame at grade	DJM
9/24/11		6.2	0.1 ft	Some grit felt	SM
6/20/13		5.8	0.5 ft	Mucky feel, debris visible in manhole and in Isolator Row, maintenance due	NV
7/7/13	6.3 ft		0	System jetted and vacuumed	DJM



## **Attachment I – Illicit Discharge Compliance Statement**

## **Illicit Discharge Compliance Statement**

### **Section I – Purpose/Intent**

The purpose of this document is to provide for the health, safety, and general welfare of the citizens of Massachusetts through the regulation of non-stormwater discharges into existing outstanding resource areas near the site to the maximum extent practicable, as required by federal and state law. This document establishes methods for controlling the introduction of pollutants into existing outstanding resource areas to comply with requirements of the National Pollutant Discharge Elimination System (NPDES) permit process.

### **Section II - Definitions**

For the purposes of this statement, the following shall mean:

*Best Management Practices (BMPs):* Schedules of activities, prohibitions of practices, general good housekeeping practices, pollution prevention and educational practices, maintenance procedures, and other management practices to prevent or reduce the discharge of pollutants directly or indirectly to stormwater, receiving waters, or stormwater conveyance systems. BMPs also include treatment practices, operating procedures, and practices to control site runoff, spillage or leaks, sludge or water disposal, or drainage from raw materials storage.

*Clean Water Act:* The federal Water Pollution Control Act (33 U.S.C § 1251 et seq.), and any subsequent amendments thereto.

*Construction Activity:* Activities subject to the Massachusetts Erosion and Sedimentation Control Act or NPDES Construction Permits. Such activities include but are not limited to clearing and grubbing, grading, excavating, and demolition.

*Hazardous Materials:* Any material, including any substance, waste, or combination thereof, which because of its quantity, concentration, or physical, chemical, or infectious characteristics may cause, or significantly contribute to, a substantial present or potential hazard to human health, safety, property, or the environment when improperly treated, stored, transported, disposed of, or otherwise managed.

*Illegal Connection:* An illegal connection is defined as either of the following:

- a. Any pipe, open channel, drain or conveyance, whether on the surface or subsurface, which allows an illicit discharge to enter the outstanding resource area including but not limited to any conveyances which allow any non-stormwater discharge including sewage, process wastewater, and wash water, regardless of whether said drain or connection has been previously allowed, permitted, or approved by an authorized enforcement agency; or

- b. Any pipe, open channel, drain or conveyance connected to the Town of Boxford storm water treatment system which has not been documented in plans, maps, or equivalent records and approved by an authorized enforcement agency.

*Illicit Discharge:* Any direct or indirect non-stormwater discharge to the Town of Boxford stormwater treatment system, except as exempted in Section III of this ordinance.

*Industrial Activity:* Activities subject to NPDES Industrial Permits as defined in 40CFR, Section 122.26 (b) (14).

*National Pollutant Discharge Elimination System (NPDES) Stormwater Discharge Permit:* A permit issued by MassDEP under authority delegated pursuant to 33 USC § 1342 (b) that authorizes the discharge of pollutants to waters of the United States, whether the permit is applicable on an individual, group, or general area-wide basis.

*Town of Boxford Stormwater Treatment System:* Any facility, owned or maintained by the Town of Boxford, designed or used for collecting and/or conveying stormwater, including but not limited to roads with drainage systems, Town of Boxford streets, curbs, gutters, inlets, catch basins, piped storm drains, pumping facilities, infiltration, retention and detention basins, natural and man-made or altered drainage channels, reservoirs, and other drainage structures.

*Non-Stormwater Discharge:* Any discharge to the storm drain system that is not composed entirely of stormwater.

*Person:* Any individual, association, organization, partnership, firm, joint venture, public or private corporation, trust, estate, commission, board, public or private institution, utility, cooperative, city, county or other political subdivision of the State, interstate body, or any other legal entity.

*Pollutant:* Anything which causes or contributes to pollution. Pollutants may include, but are not limited to: paints, varnishes, and solvents; petroleum hydrocarbons; automotive fluids; cooking grease; detergents (biodegradable or otherwise); degreasers; cleaning chemicals; non-hazardous liquid and solid wastes; refuse, rubbish, garbage, litter, or other discarded or abandoned objects and accumulations, so that same may cause or contribute to pollution; floatables; pesticides, herbicides, and fertilizers; liquid and solid wastes; sewage, fecal coliform and pathogens; dissolved and particulate metals; animal wastes; wastes and residues that result from constructing a building or structure; concrete and cement; and noxious or offensive matter of any kind.

*Pollution:* Contamination or other alteration of any water's physical, chemical, or biological properties by addition of any constituent including but not limited to a change in temperature, taste, color, turbidity, or odor of such waters, or the discharge of any liquid, gaseous, solid, radioactive, or other substance into any such waters as will or is likely to create a nuisance or render such waters harmful, detrimental, or injurious to the

public health, safety, welfare, or environment, or to domestic, commercial, industrial, agricultural, recreational, or other legitimate beneficial uses, or to livestock, wild animals, birds, fish or other aquatic life.

*Premises:* Any building, lot, parcel of land, or portion of land whether improved or unimproved including adjacent sidewalks and parking strips.

*Stormwater:* Any surface flow, runoff, and drainage consisting entirely of water from any form of natural precipitation and resulting from such precipitation.

*Wastewater:* Any water or other liquid discharged from a facility, that has been used, as for washing, flushing, or in a manufacturing process, and so contains waste products.

### **Section III - Prohibitions**

#### *Prohibition of Illicit Discharges:*

No person shall throw, drain, or otherwise discharge, cause or allow others under its control to throw, drain, or otherwise discharge into the Town of Boxford stormwater treatment system or watercourses any materials, including but not limited to, any pollutants or waters containing any pollutants, other than stormwater. It is to the best knowledge and belief of the project proponent that no illicit discharges currently exist at the project site. The commencement, conduct or continuance of any illicit discharge to the storm drain system is prohibited except as described as follows:

1. Water line flushing performed by a government agency, other potable water sources, landscape irrigation or lawn watering, diverted stream flows, rising ground water, ground water infiltration to storm drains, uncontaminated pumped ground water, foundation or footing drains (not including active groundwater dewatering systems), crawl space pumps, air conditioning condensation, springs, natural riparian habitat or wetland flows, and any other water source not containing pollutants;
2. Discharges or flows from fire fighting, and other discharges specified in writing by the Town of Boxford as being necessary to protect public health and safety;
3. Dye testing is an allowable discharge, but requires notification to the Town of Boxford prior to the time of the test;
4. Any non-stormwater discharge permitted under an NPDES permit, waiver, or waste discharge order issued to the discharger and administered under the authority of the Federal Environmental Protection Agency, provided that the discharger is in full compliance with all requirements of the permit, waiver, or order and other applicable laws and regulations, and provided that written approval has been granted for a discharge to the Town of Boxford stormwater treatment system.

**Section IV - Industrial or Construction Activity Discharges**

Any person subject to an industrial or construction activity NPDES stormwater discharge permit shall comply with all provisions of such permit. Proof of compliance with said permit may be required in a form acceptable to the Town of Boxford prior to allowing discharges to the Town of Boxford stormwater treatment system.

**Section V - Notification of Spills and Accidental Discharges**

Notwithstanding other requirements of law, as soon as any person responsible for a facility, activity or operation, or responsible for emergency response for a facility, activity or operation has information of any known or suspected release of pollutants or non-stormwater discharges from that facility, activity, or operation which are resulting or may result in illicit discharges or pollutants discharging into stormwater, the Town of Boxford stormwater treatment system, State Waters, or Waters of the U.S., said person shall take all necessary steps to ensure the discovery, containment, and cleanup of such release so as to minimize the effects of the discharge. In the event of such a release of hazardous materials, said person shall immediately notify emergency response agencies of the occurrence via emergency dispatch services. In the event of a release of non-hazardous materials, said person shall notify the Town of Boxford in person or by phone no later than the next business day, including the nature, quantity and time of occurrence of the discharge. Notifications in person or by phone shall be confirmed by written notice, via certified mail return receipt requested addressed to the Town of Boxford within three (3) business days of the initial notice. If the discharge of prohibited materials emanates from a commercial or industrial establishment, the owner or operator of such establishment shall also retain an on-site written record of the discharge and the actions taken to prevent its recurrence. Such records shall be retained for at least three years.

IN WITNESS WHEREOF the parties hereto have executed copies of this Agreement on the \_\_\_\_\_ day of \_\_\_\_\_, \_\_\_\_\_.

---